

**Learn to Draw**

**A Step By Step Guide to  
Drawing and Creating  
Cool Things**

**For Kids Ages 8-12**

Copyright © Sparkle Learning, 2024

All rights reserved. No part of this book may be reproduced in any form by electronic or mechanical means, including information storage and retrieval systems, without permission in writing from the publisher, except by a reviewer who may quote brief passages in a review.

Illustrations copyright © 2024 by Sparkle Learning.

ISBN: 978-1-7382385-5-2

This paperback edition was first published in 2024.

Sparkle Learning

## HOW TO USE THIS BOOK

- 1. You will need a pencil, eraser, and colored pencil crayons.**
- 2. Follow the step by step numbered arrows to create your drawing in the « Practice » space.**
- 3. Color your final drawing.**
- 4. Have fun!**

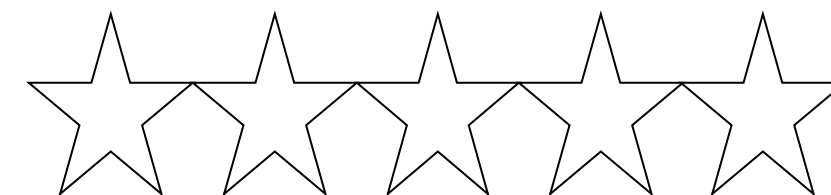

**This Book Belongs To:**

---

---

---

---

## *Penguin*

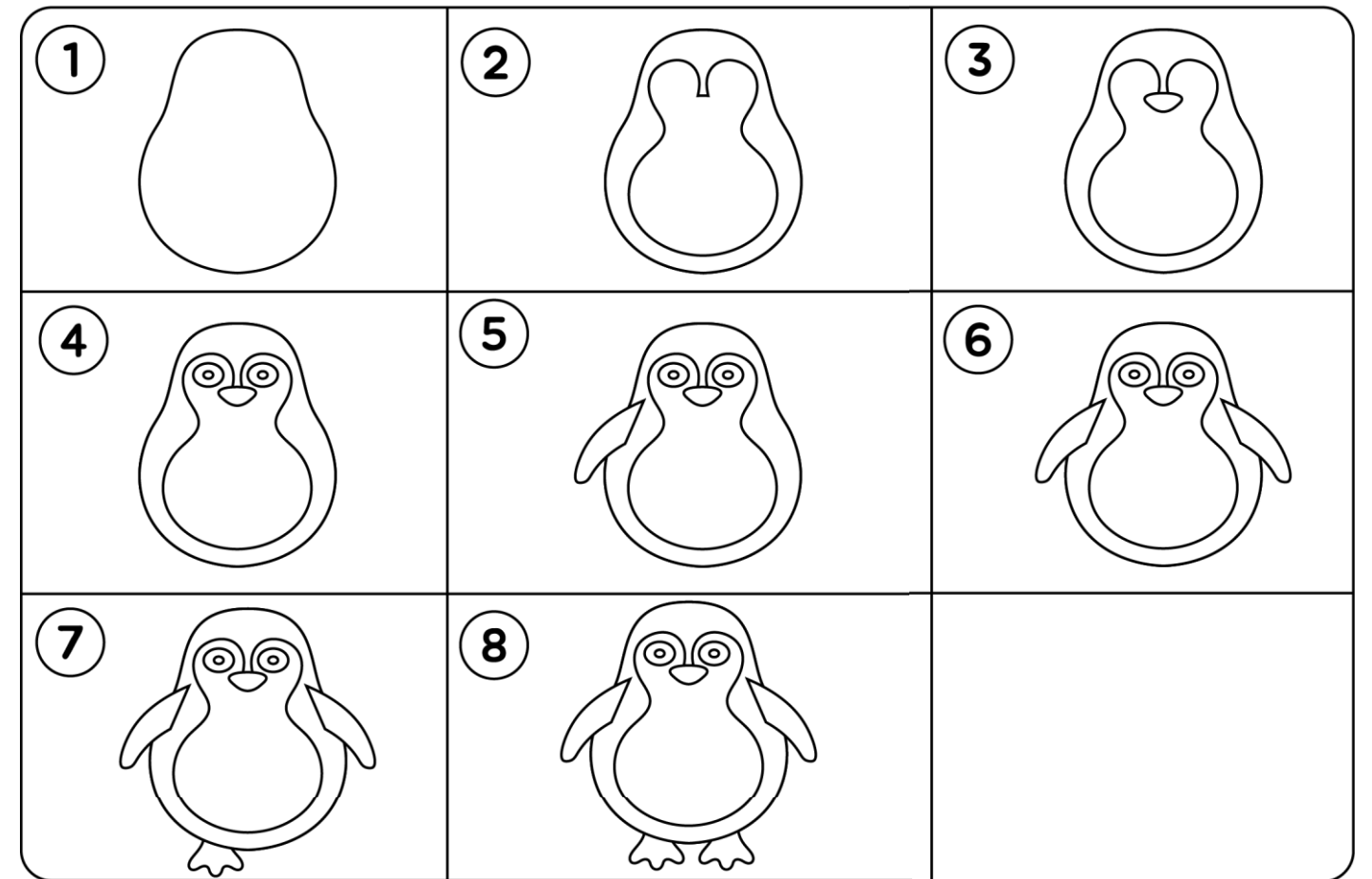

## *Practice*

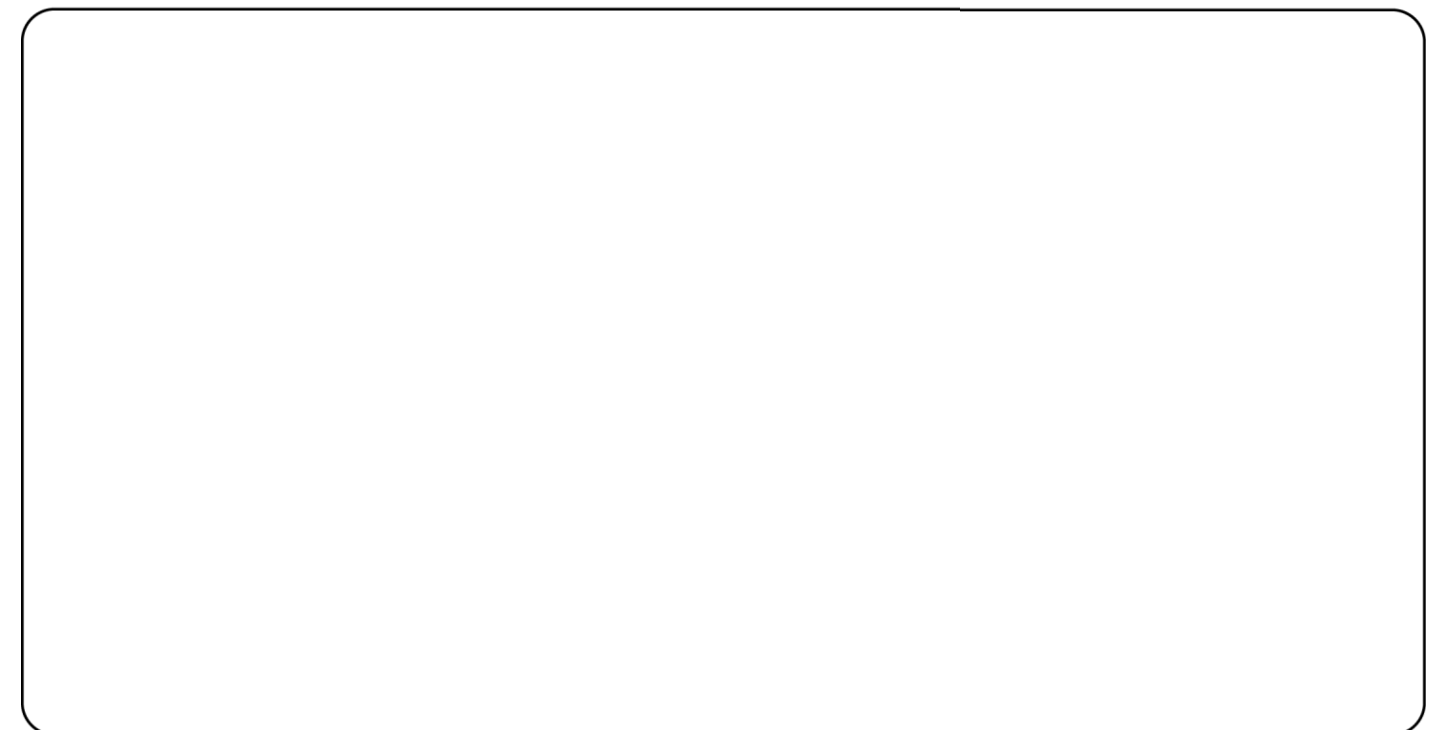

# Shark

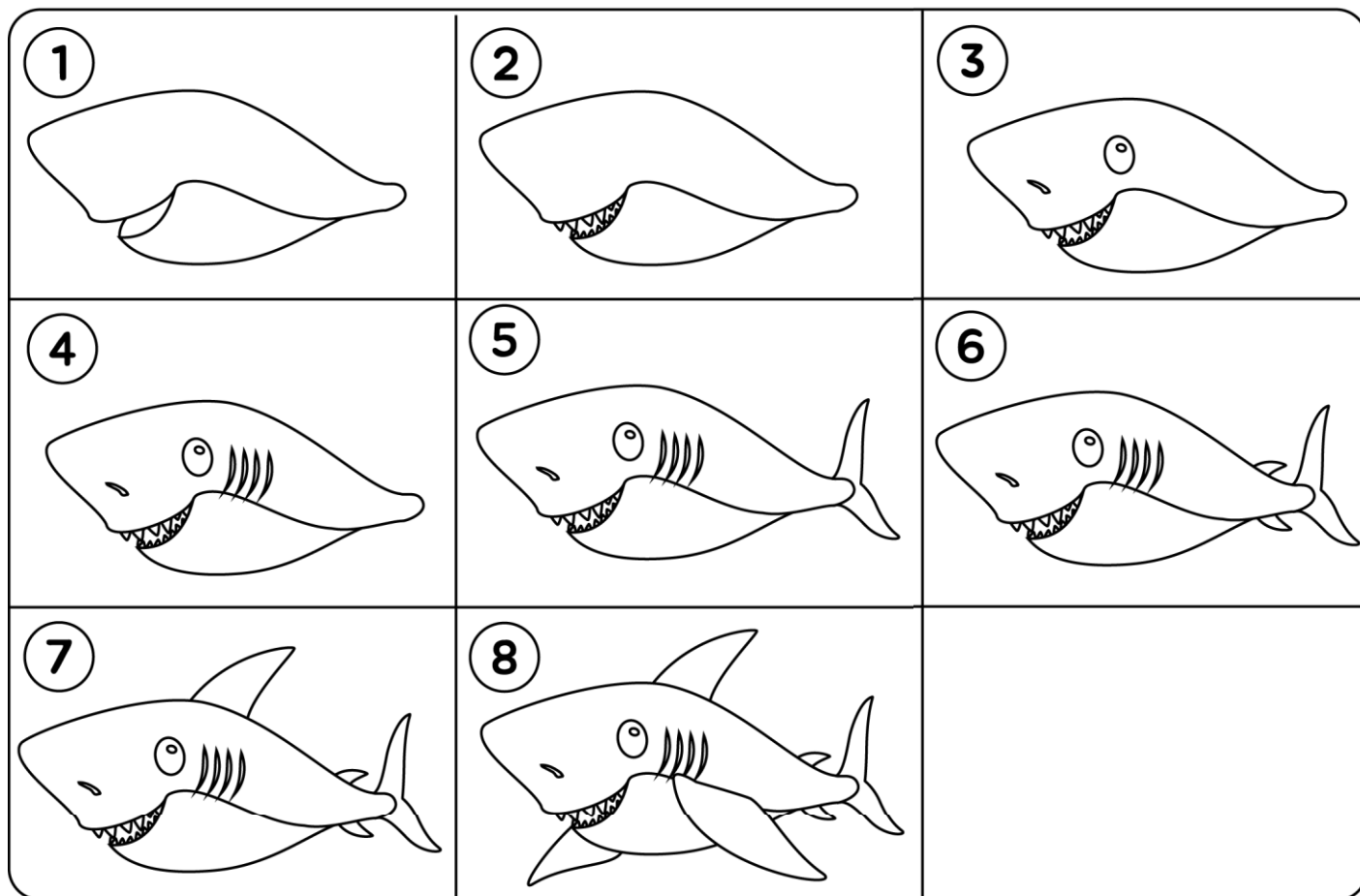

## Practice



# Beaver

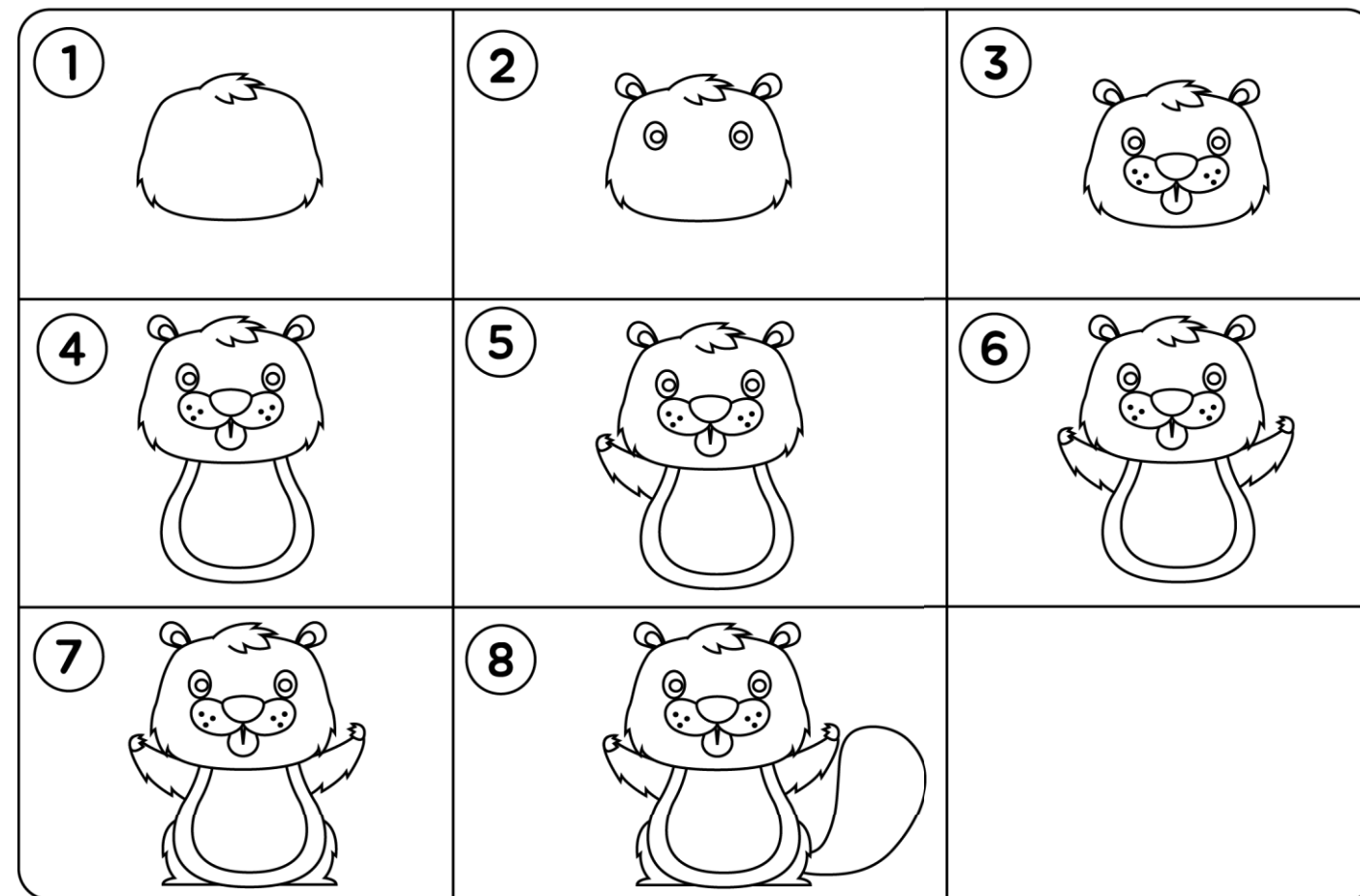

## Practice



# Fish

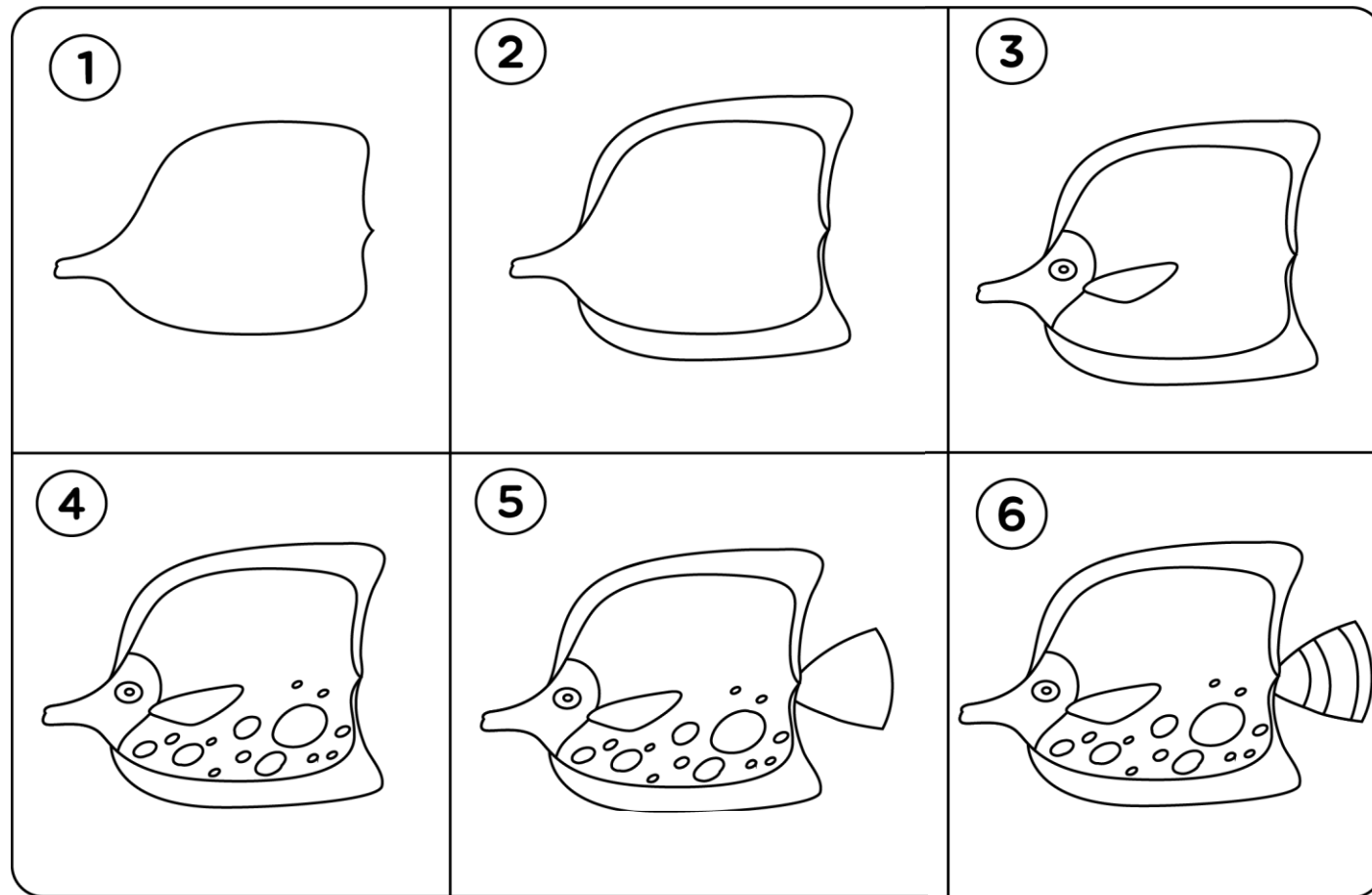

## Practice

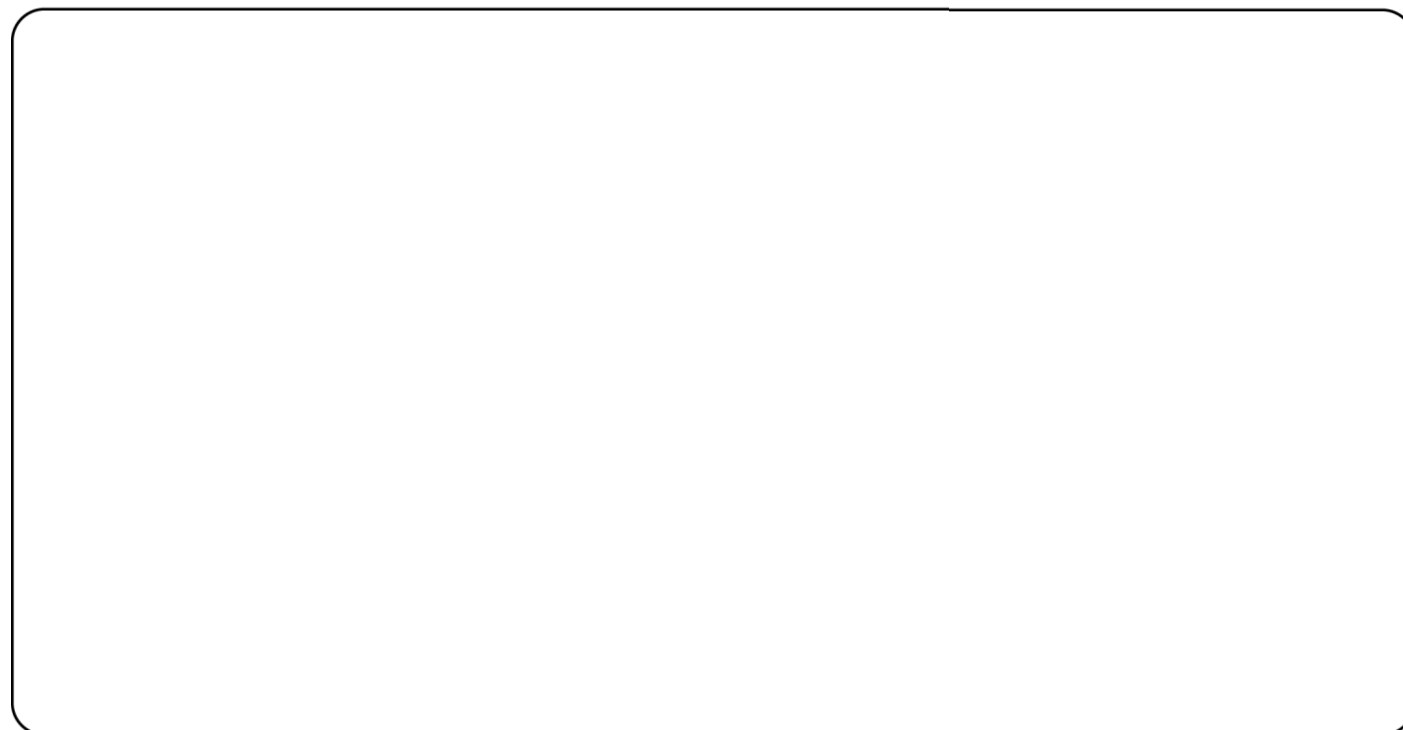

# Tractor

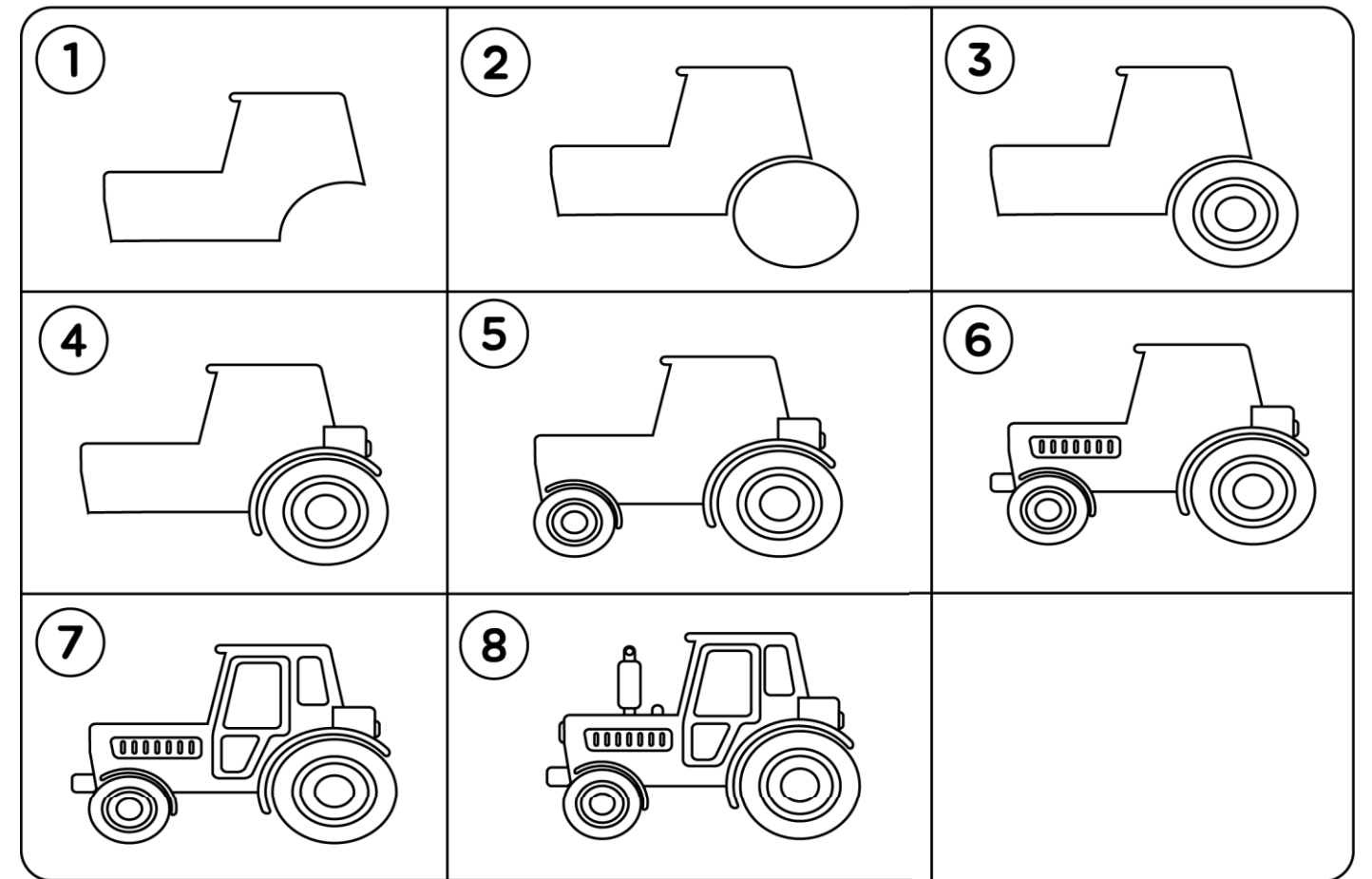

## Practice

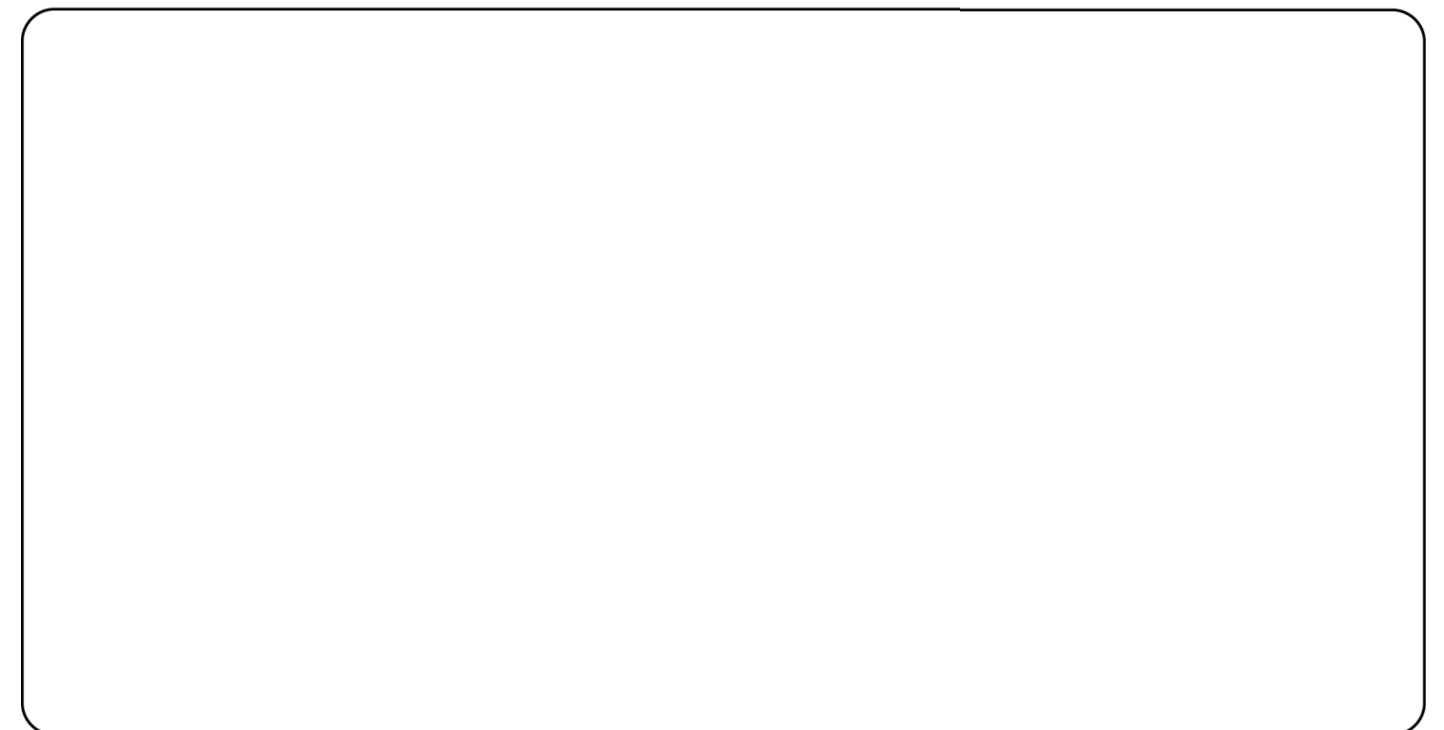

# Sloth

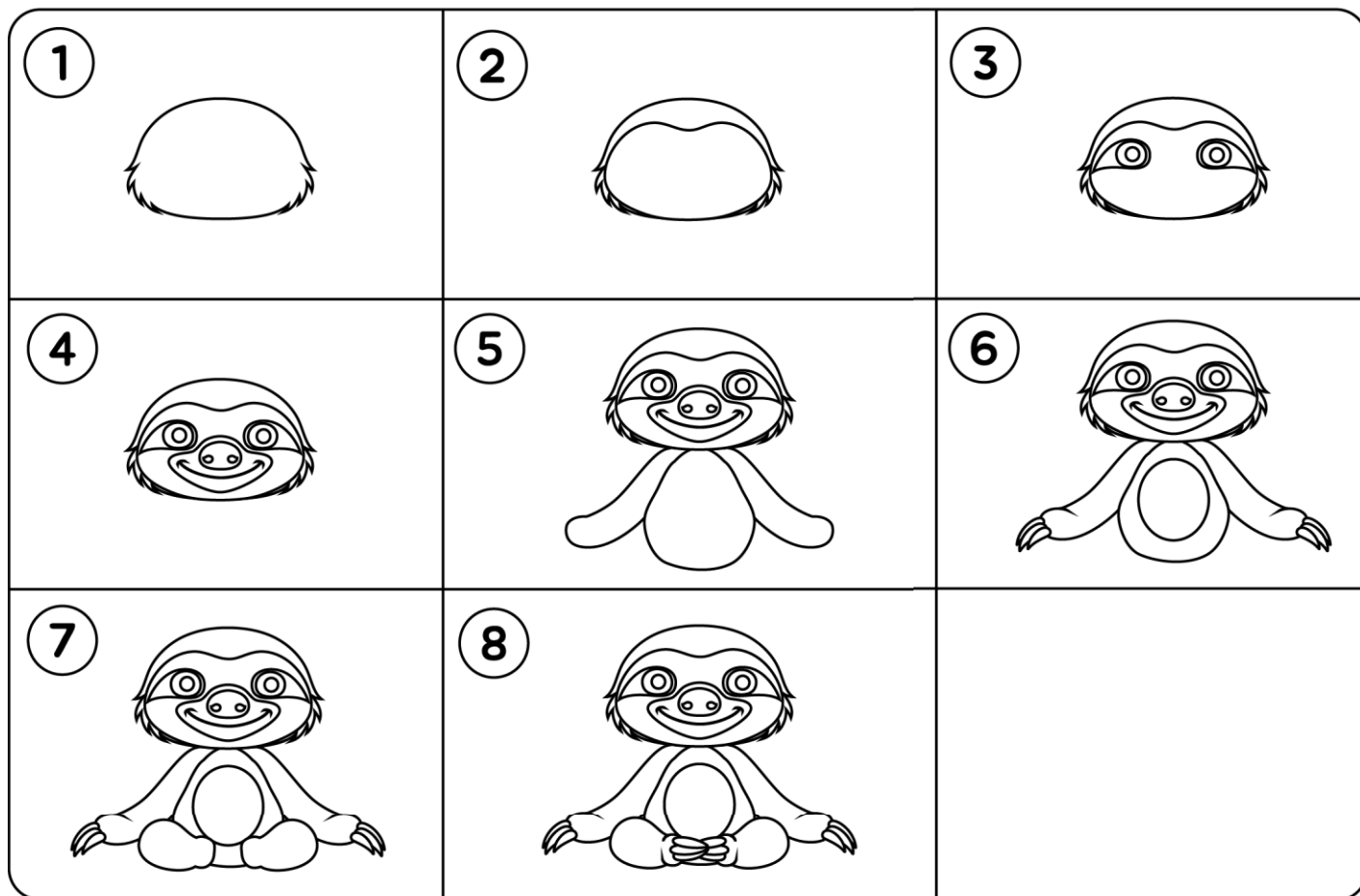

## Practice



# Chair

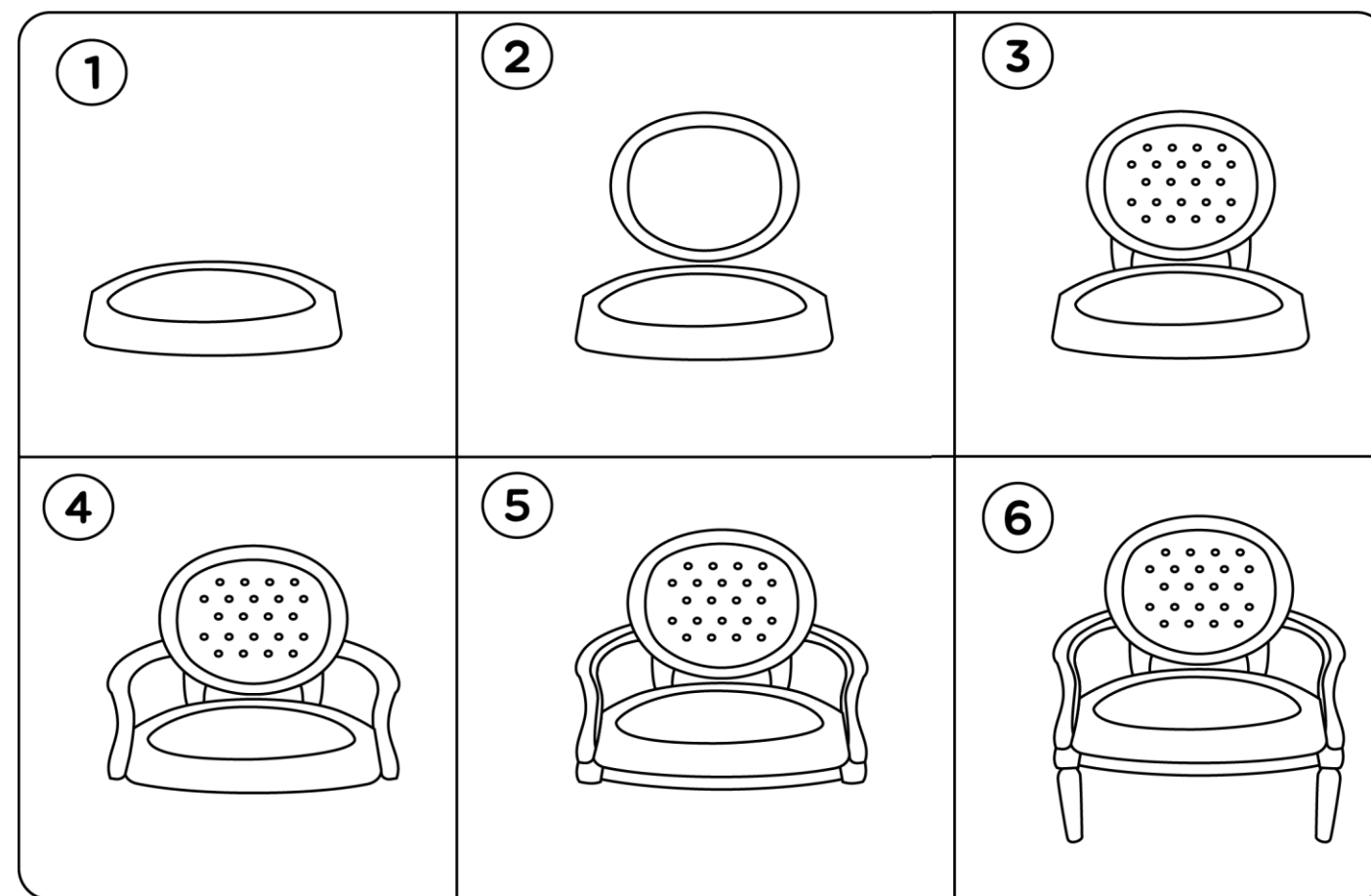

## Practice



# Owl

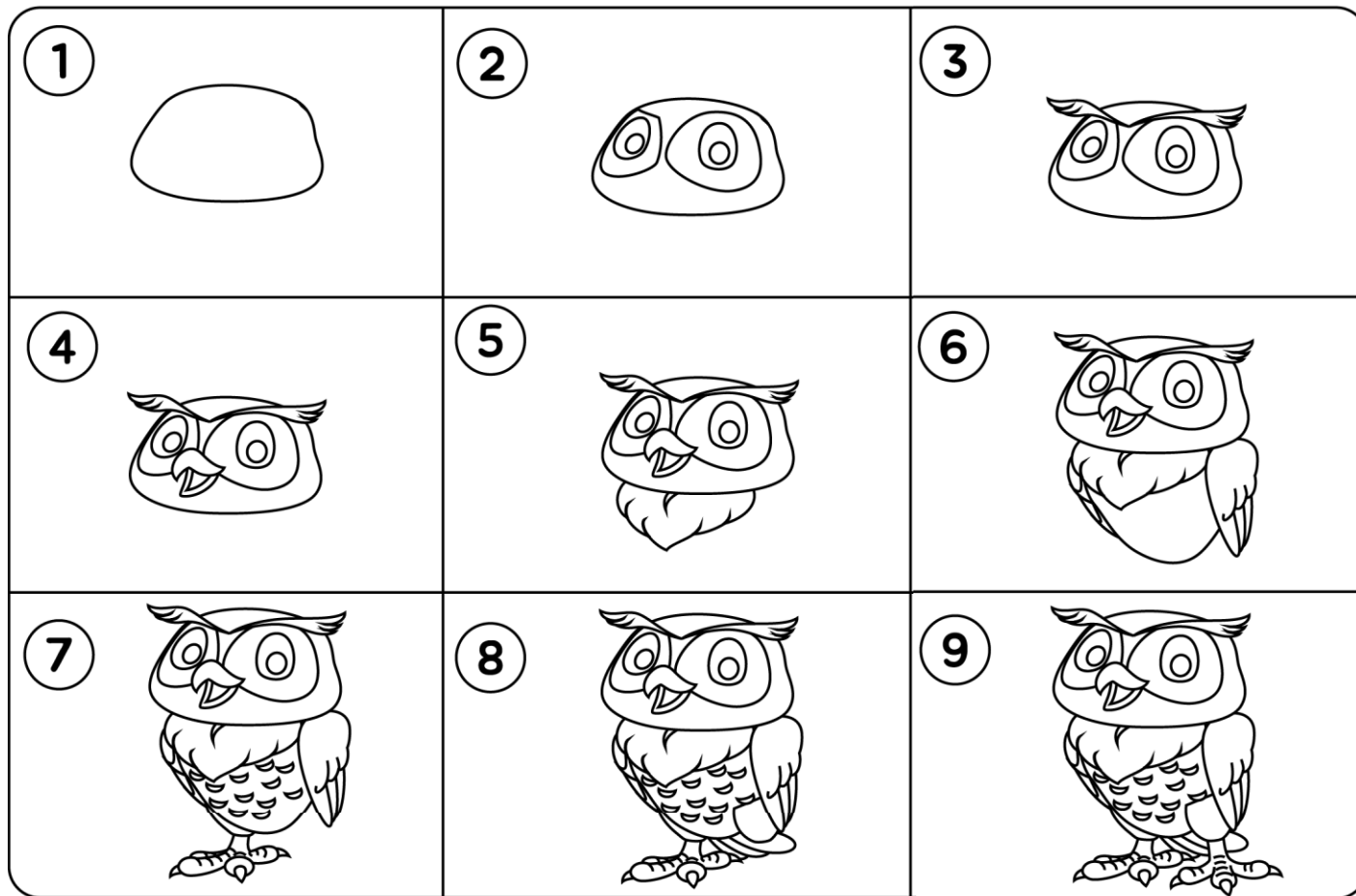

## Practice

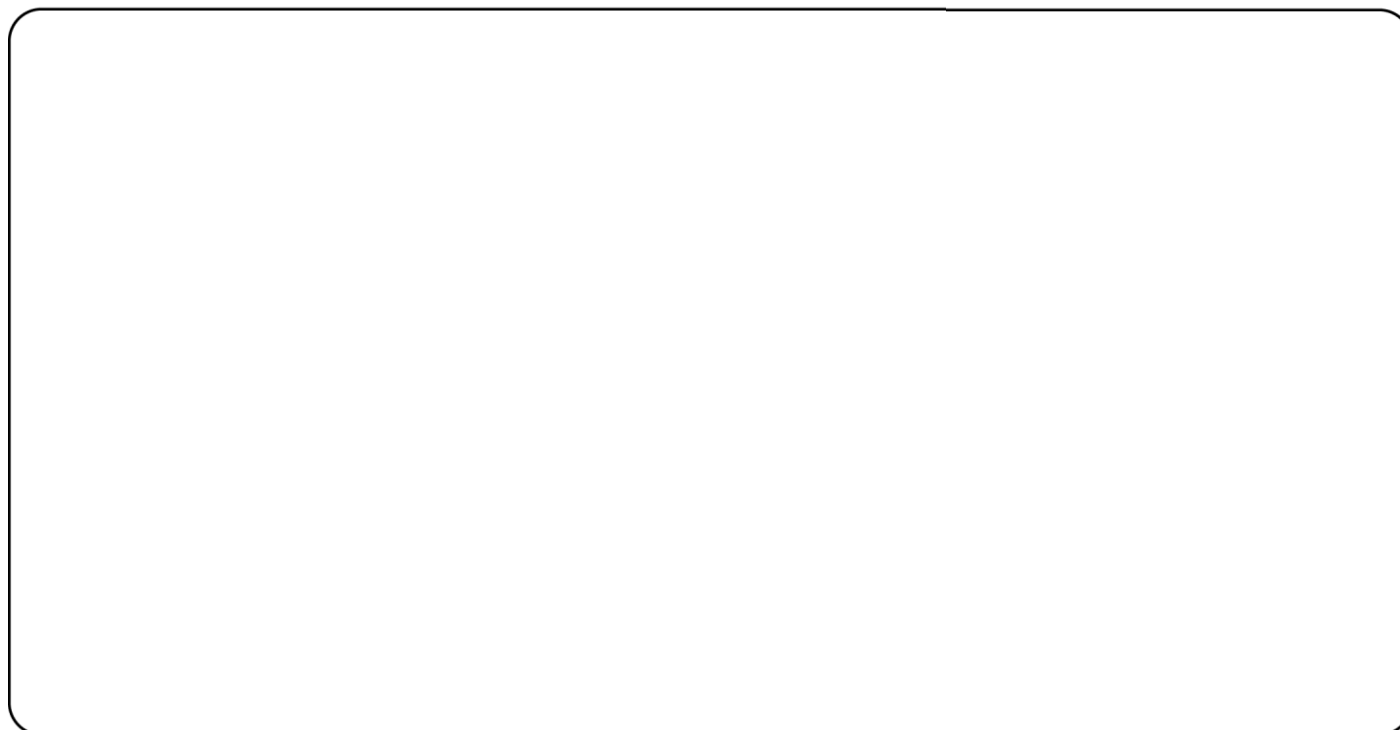

# Frog

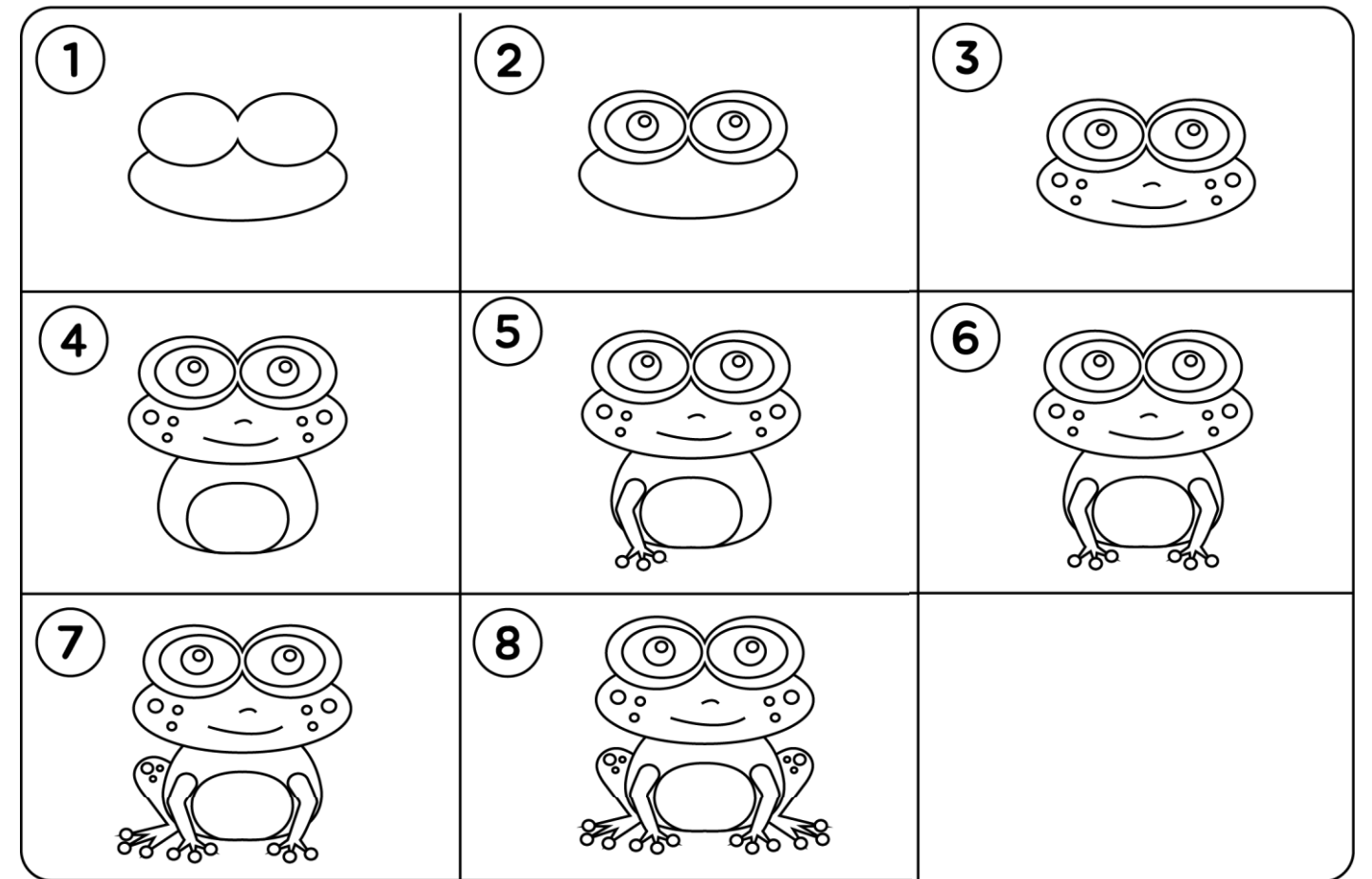

## Practice

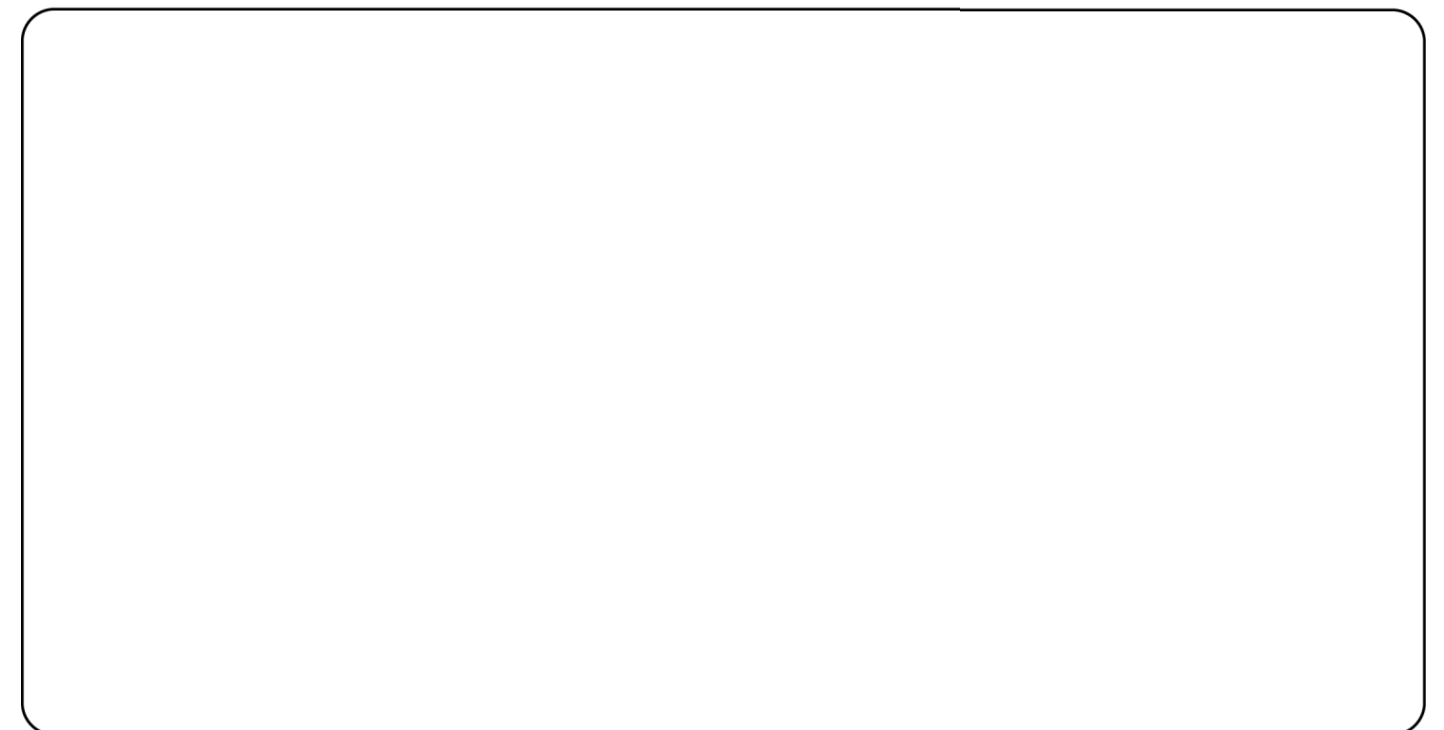

# Snail

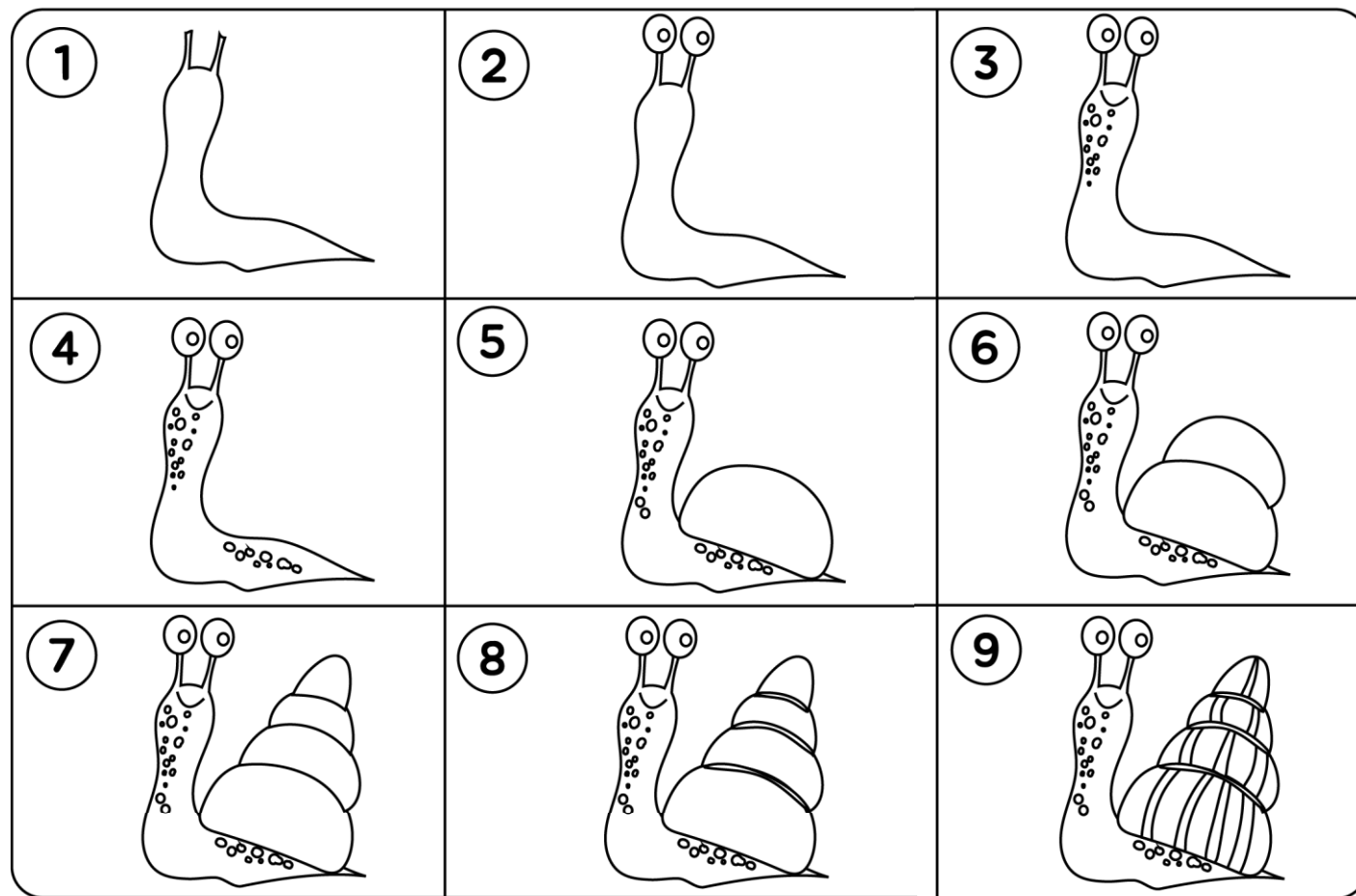

## Practice

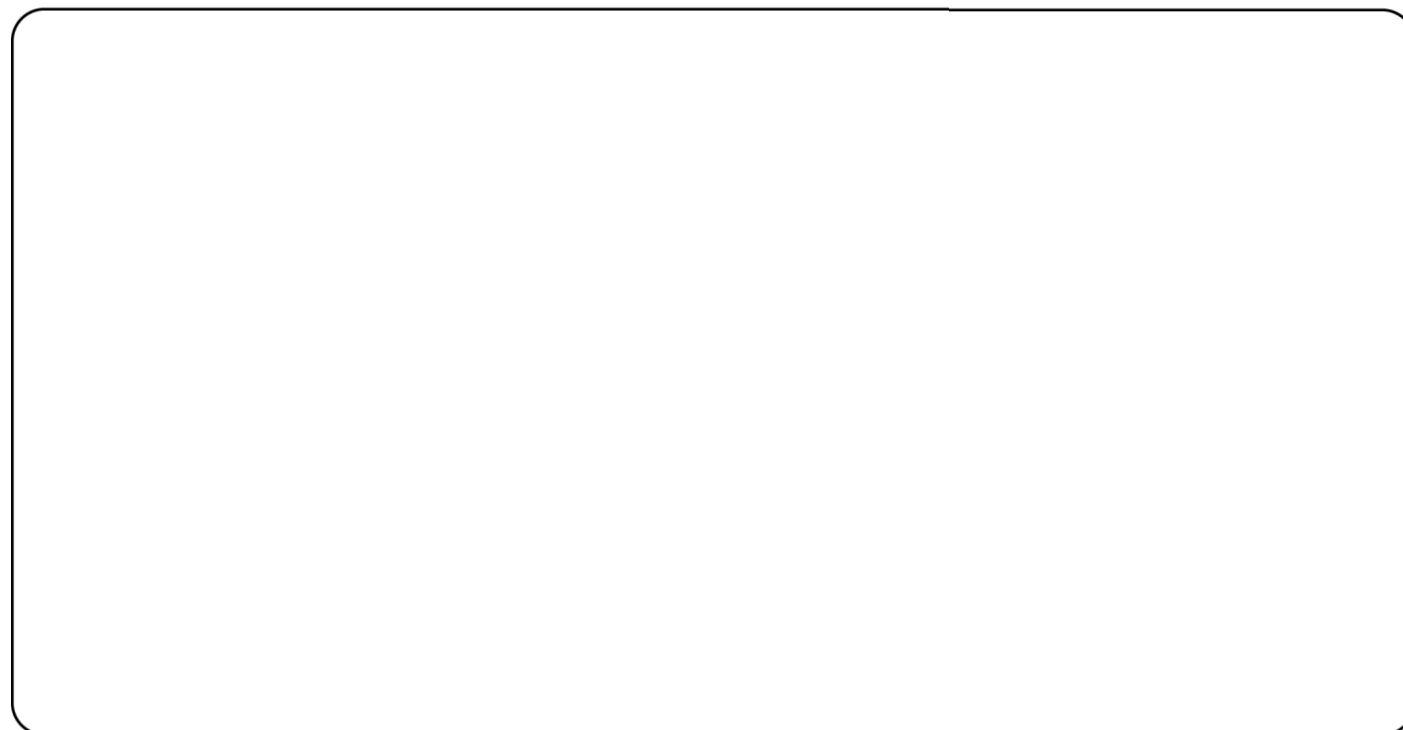

# Gnome

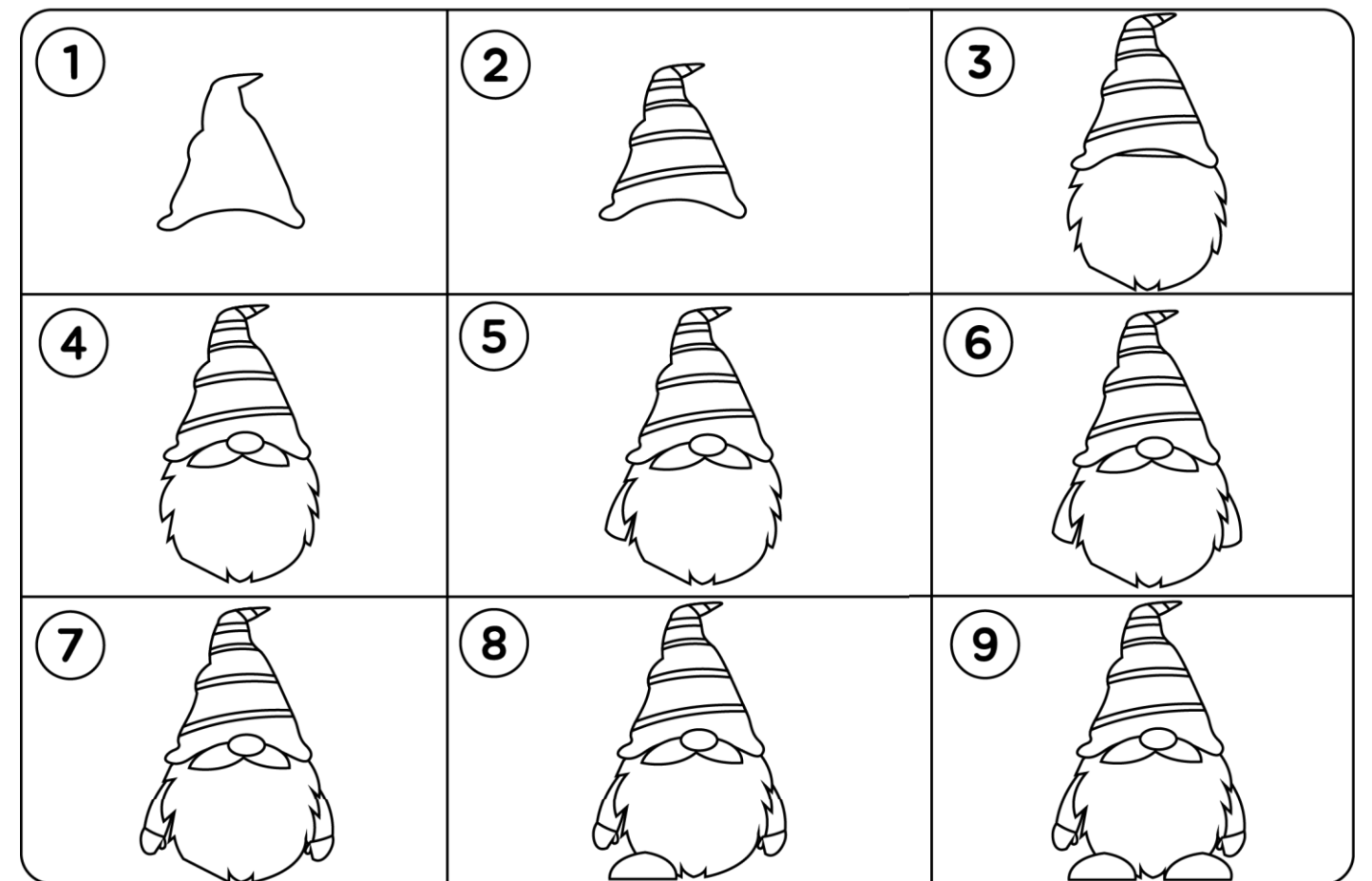

## Practice



# Helicopter

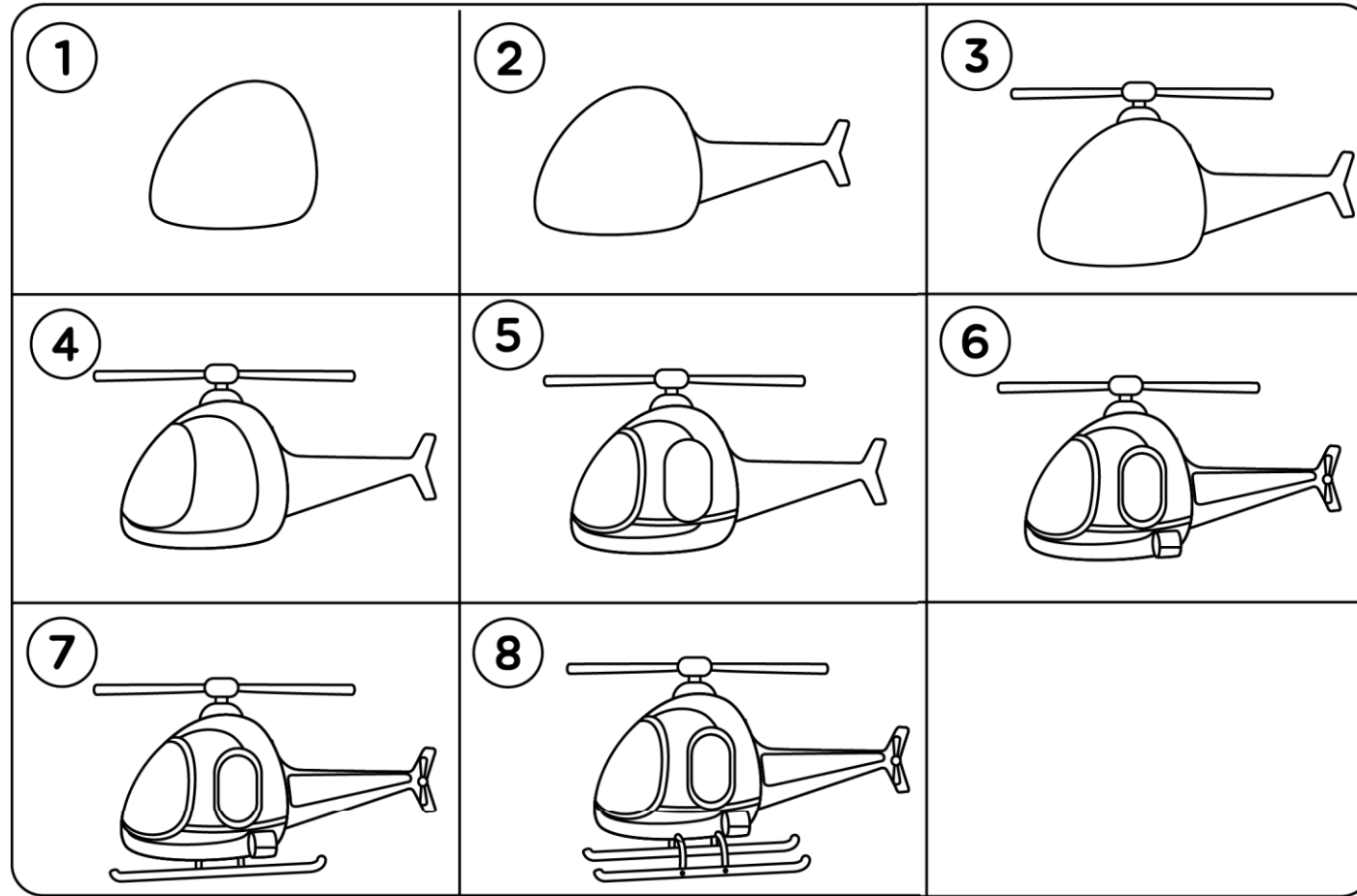

## Practice

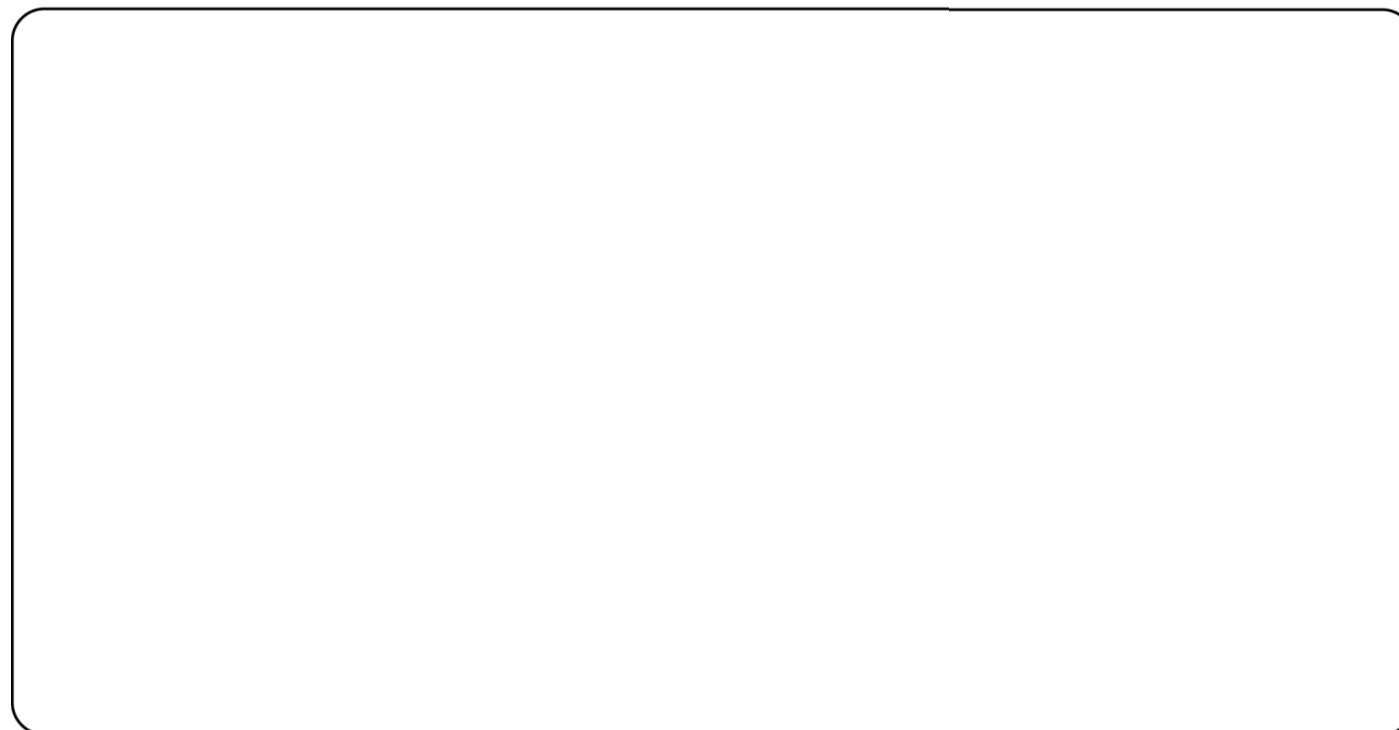

# Rabbit

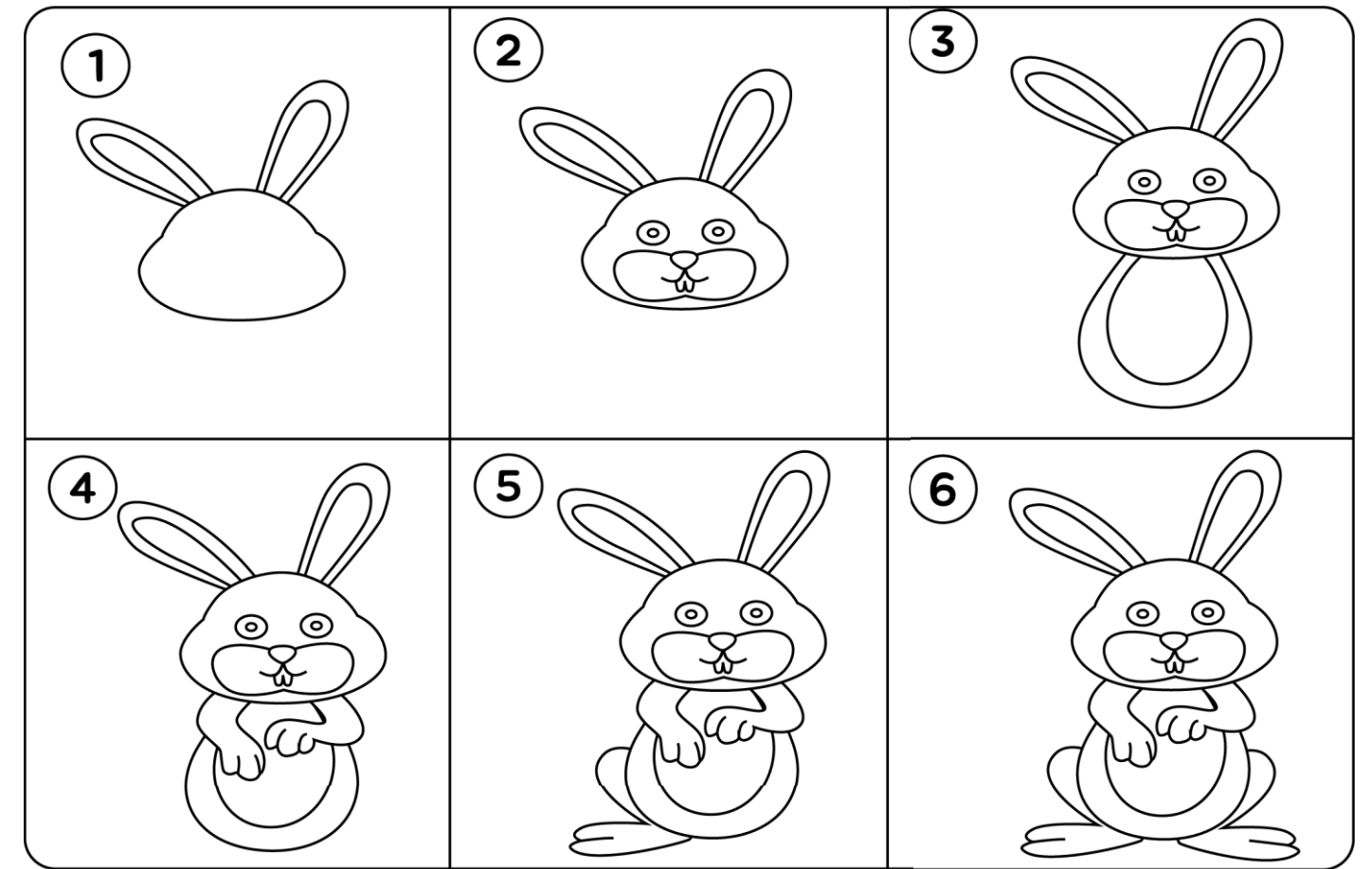

## Practice

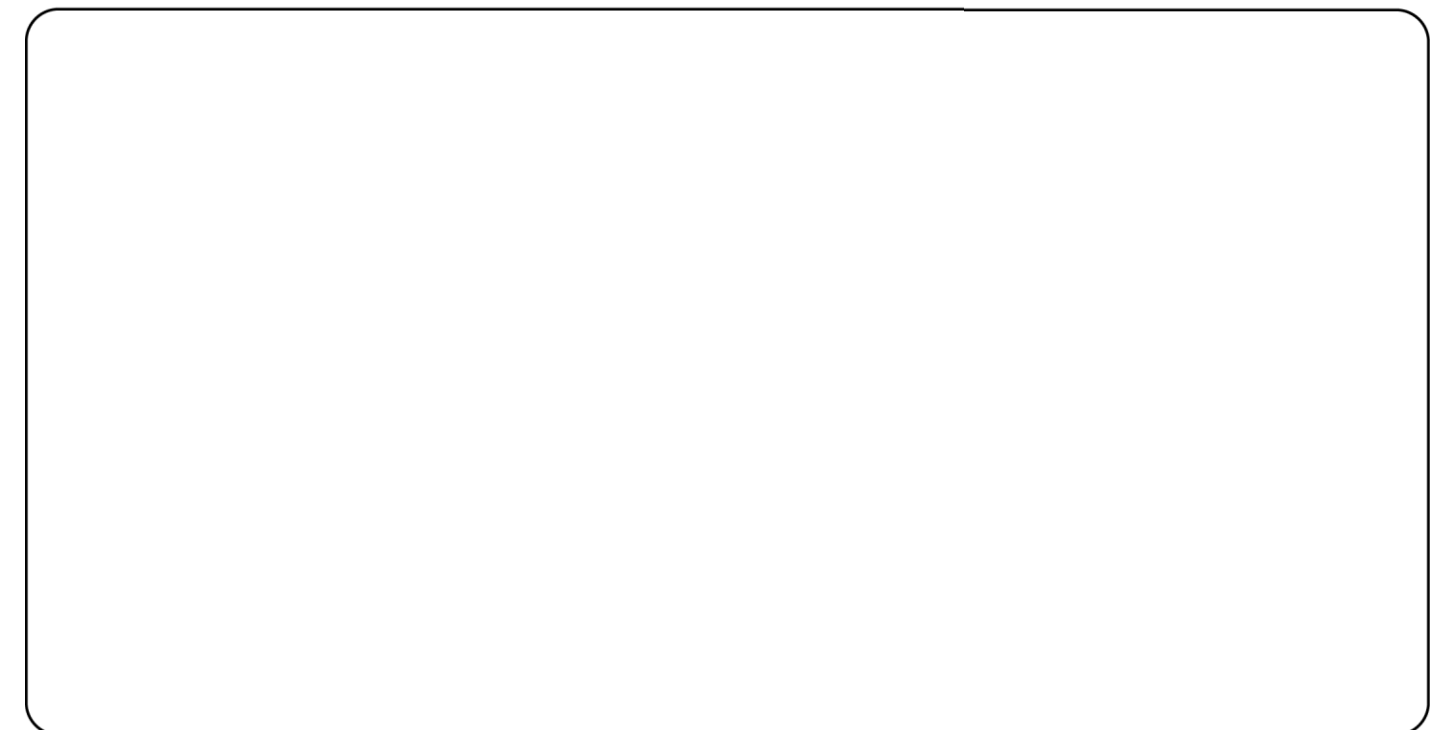

# Tomato

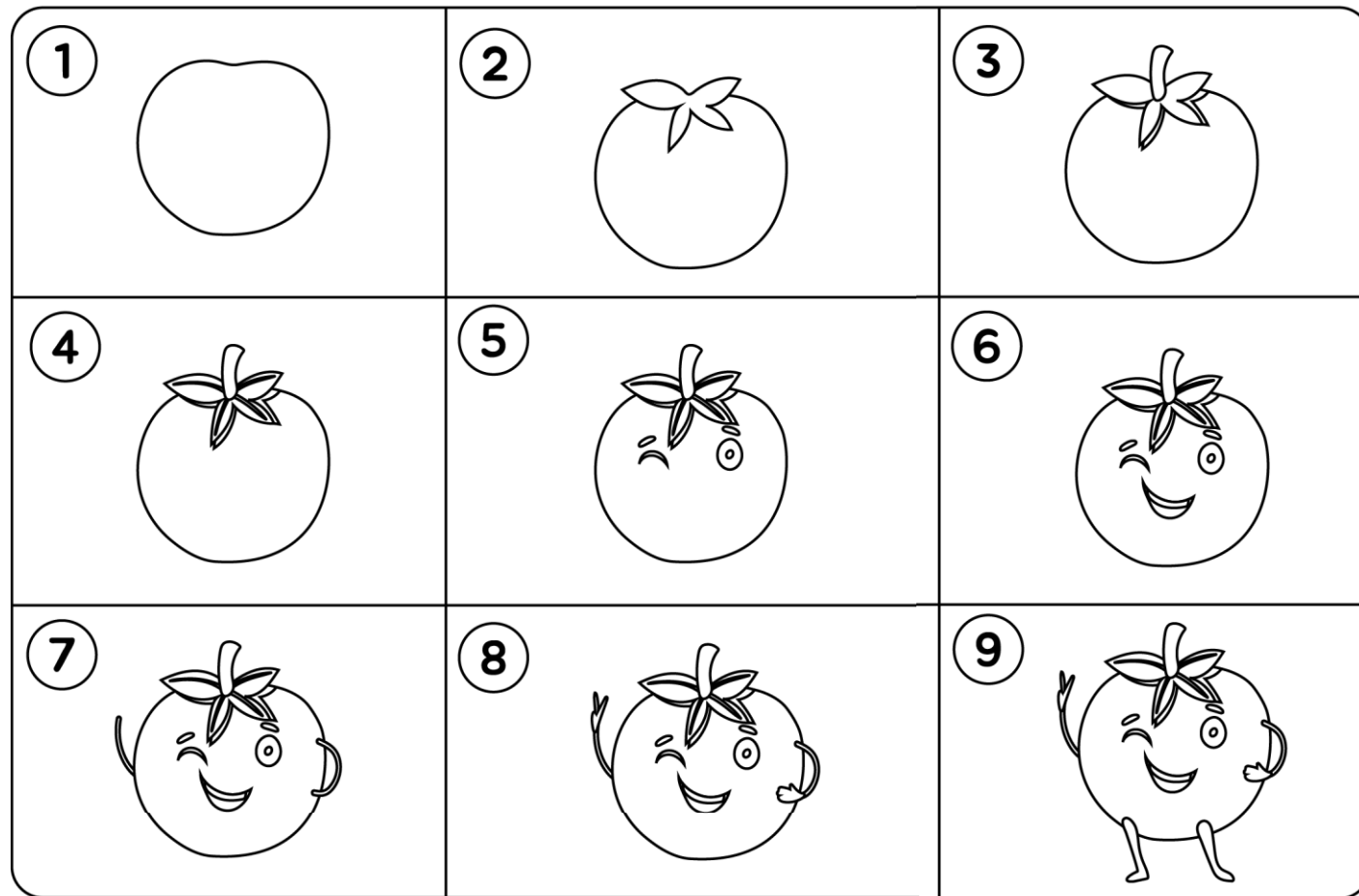

## Practice

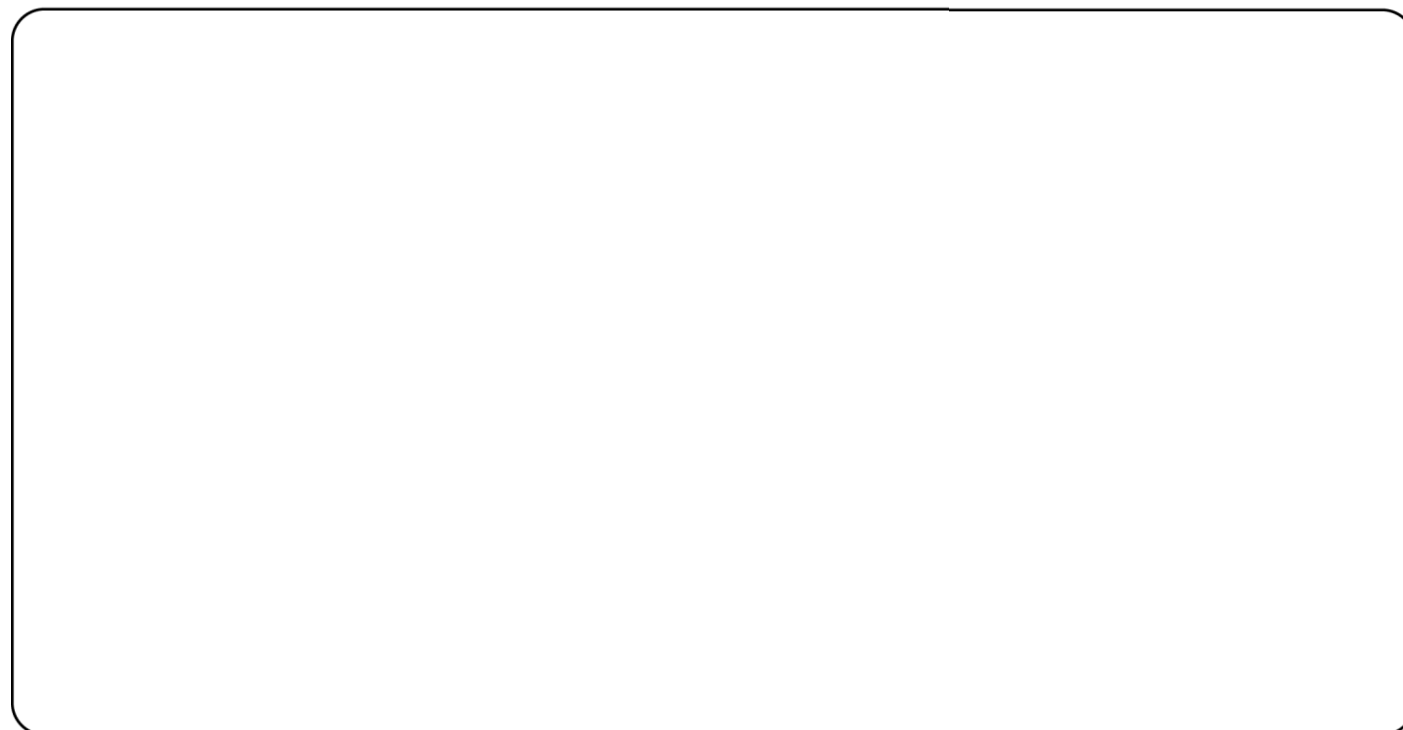

# Anteater

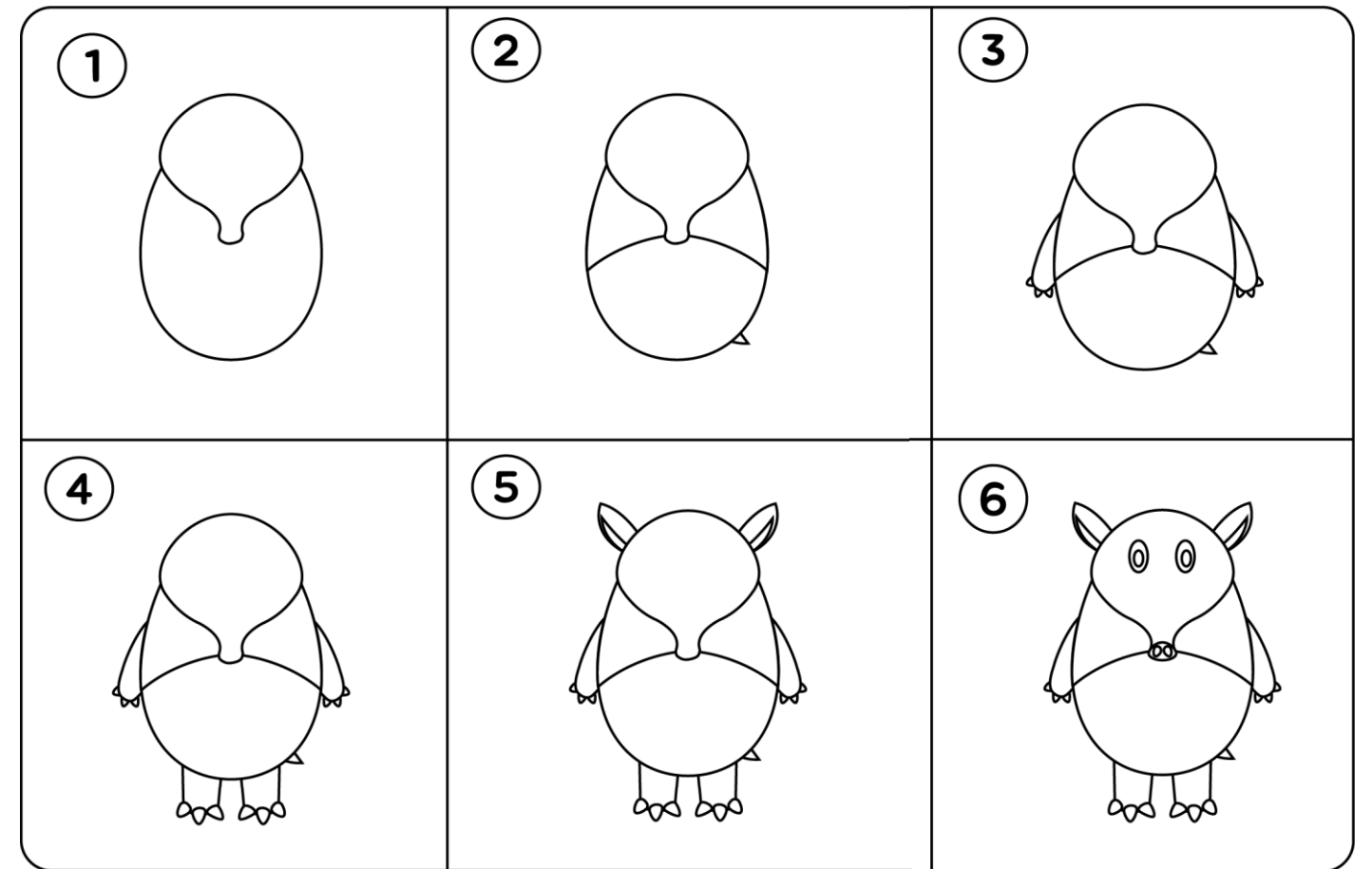

## Practice

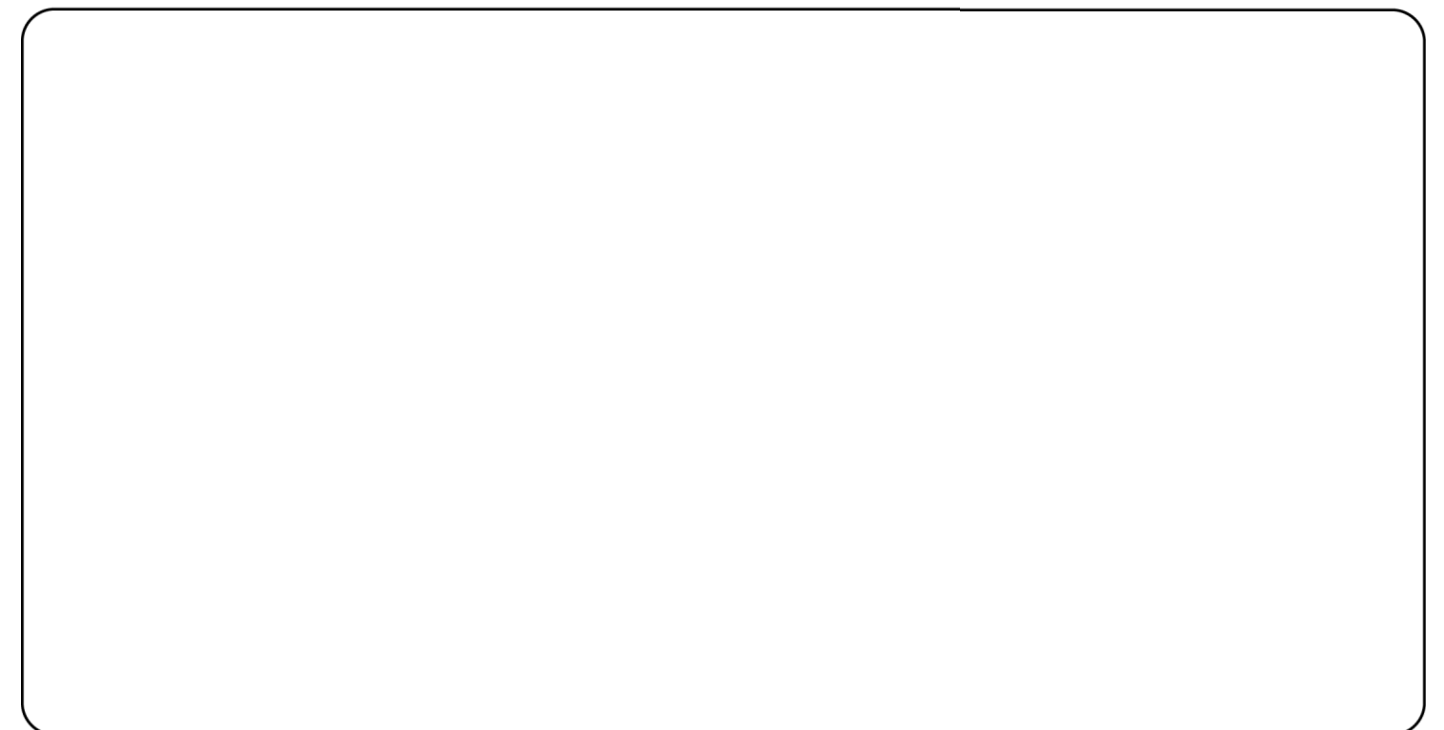

# Bulldog

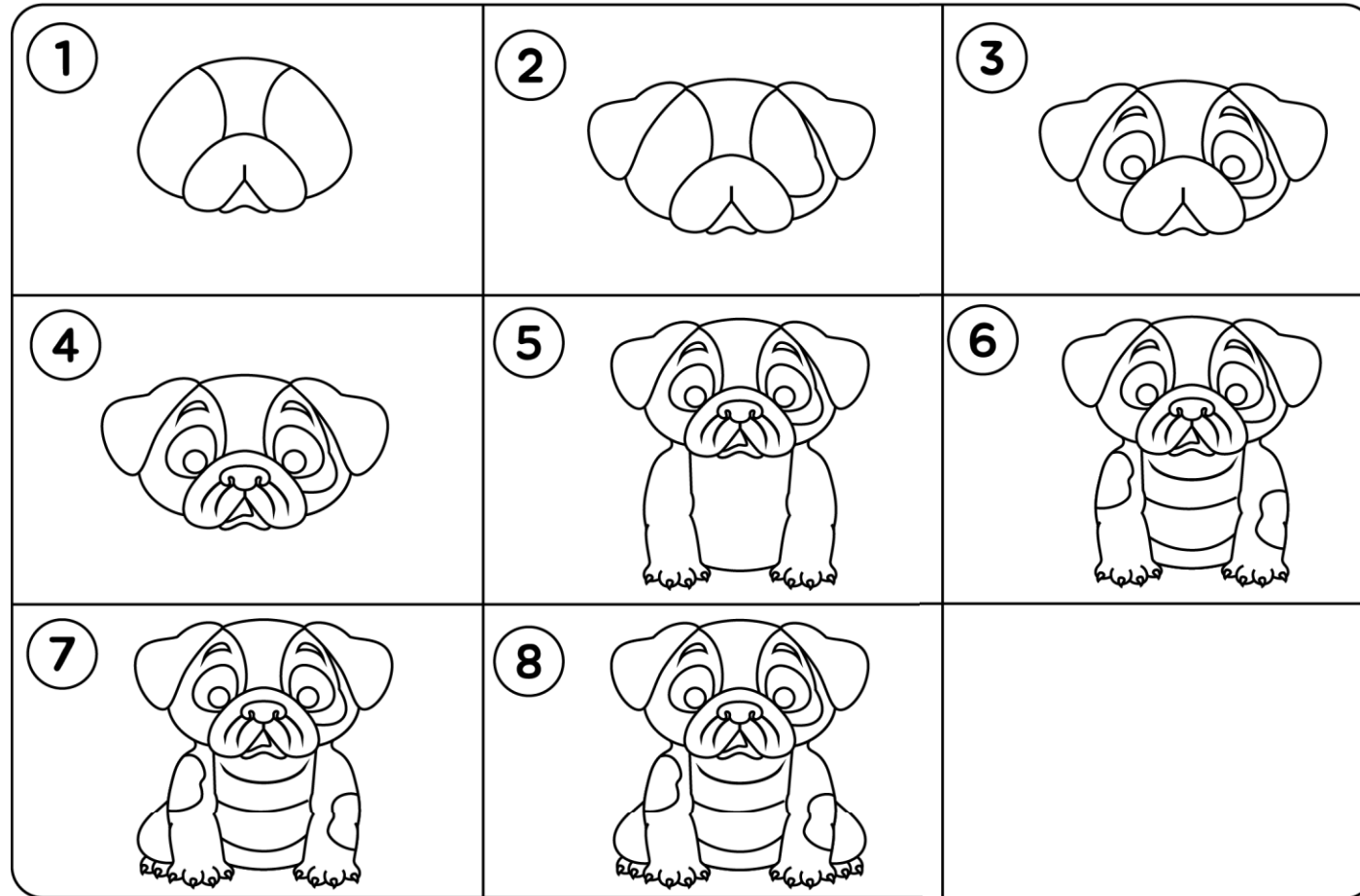

## Practice

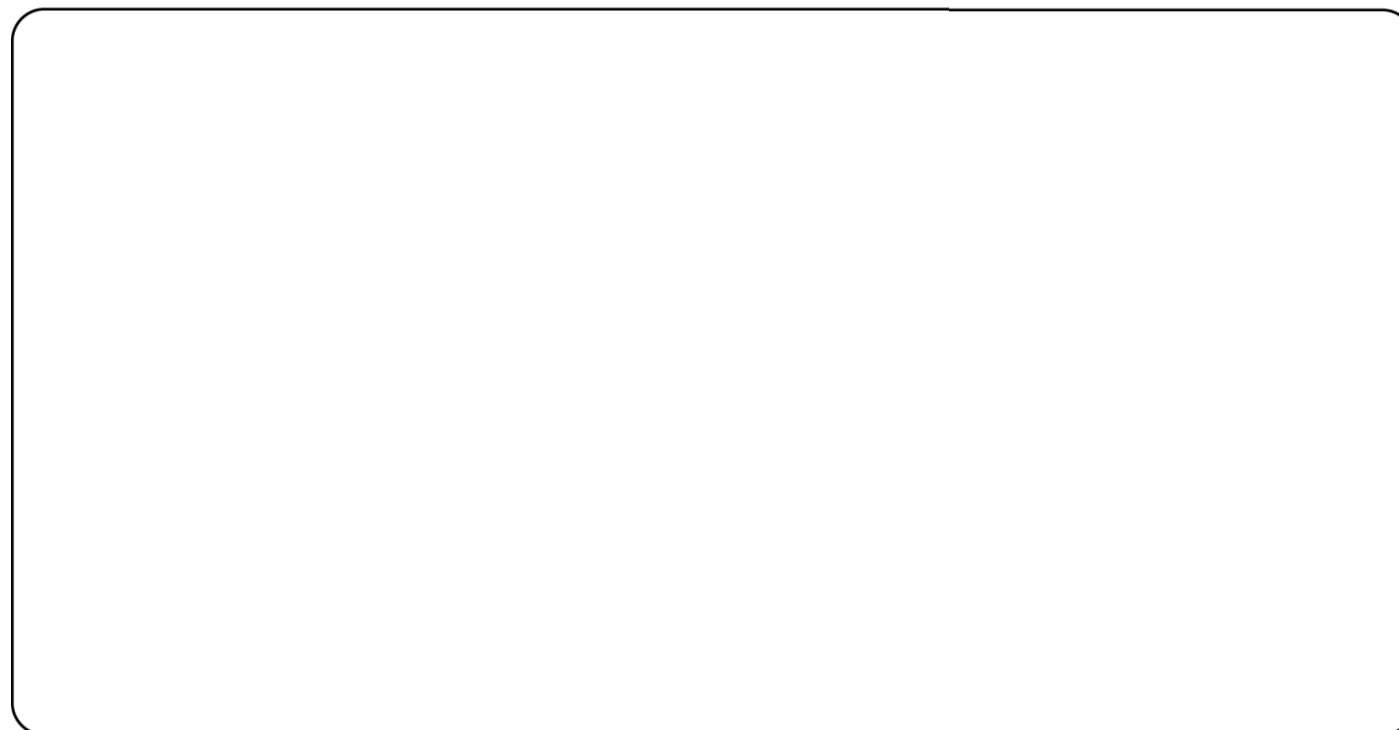

# Grasshopper

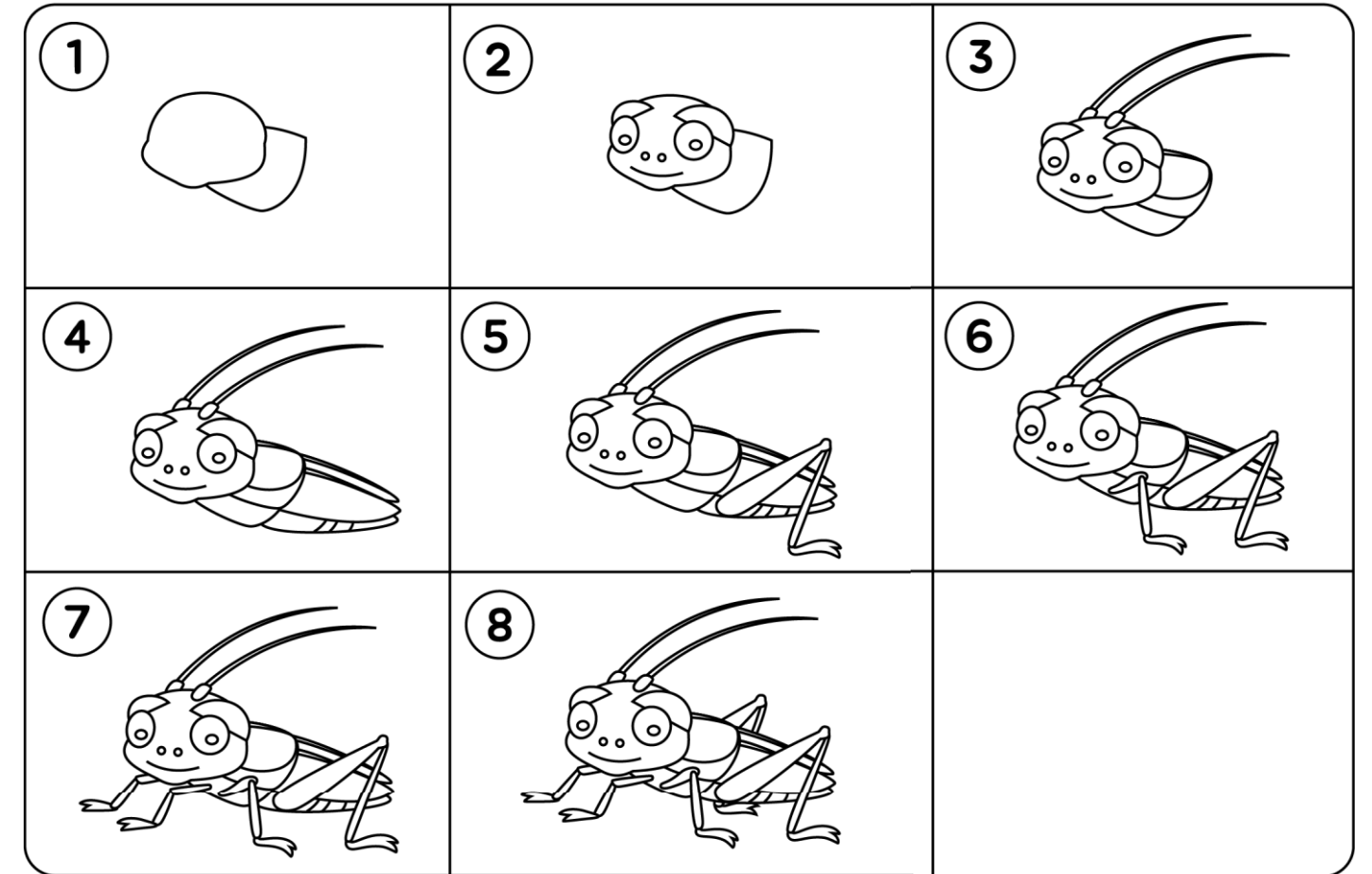

## Practice

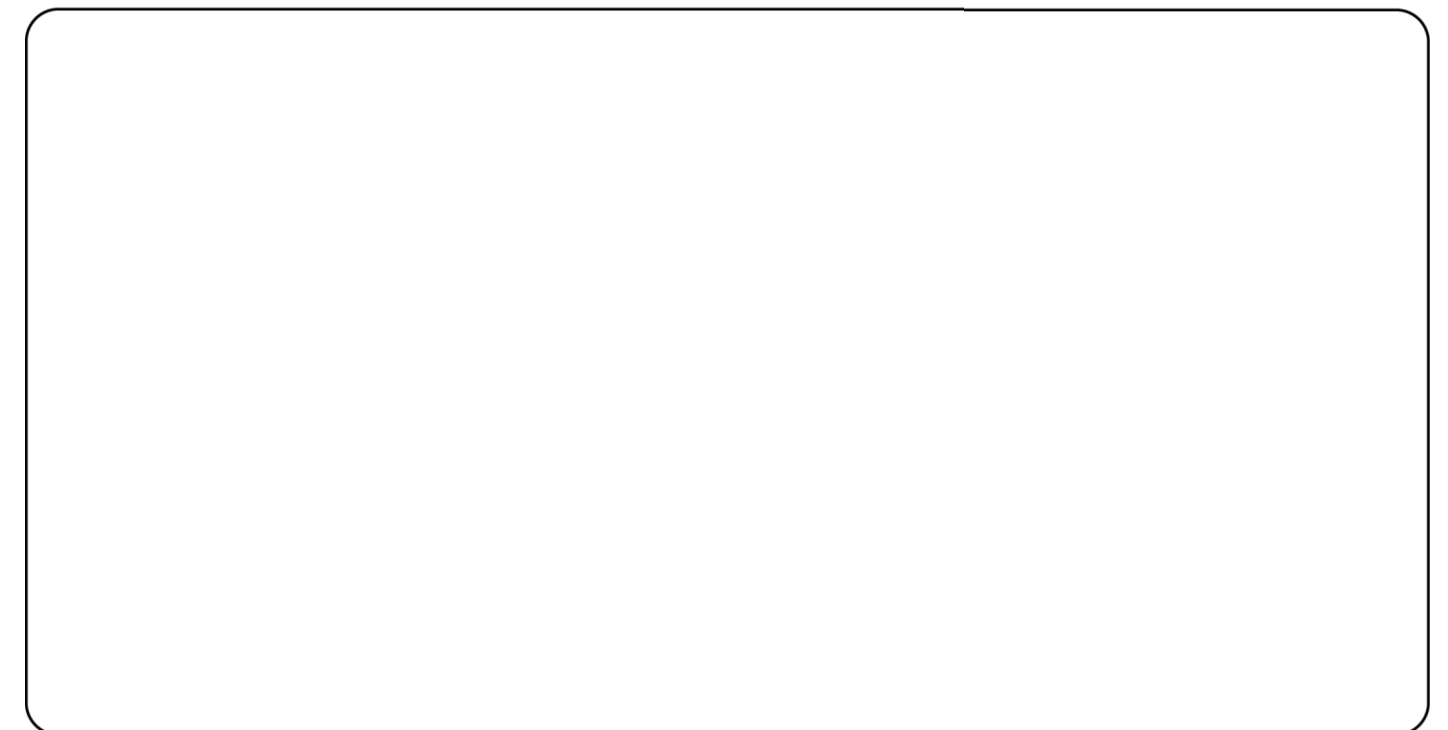

# Mongoose

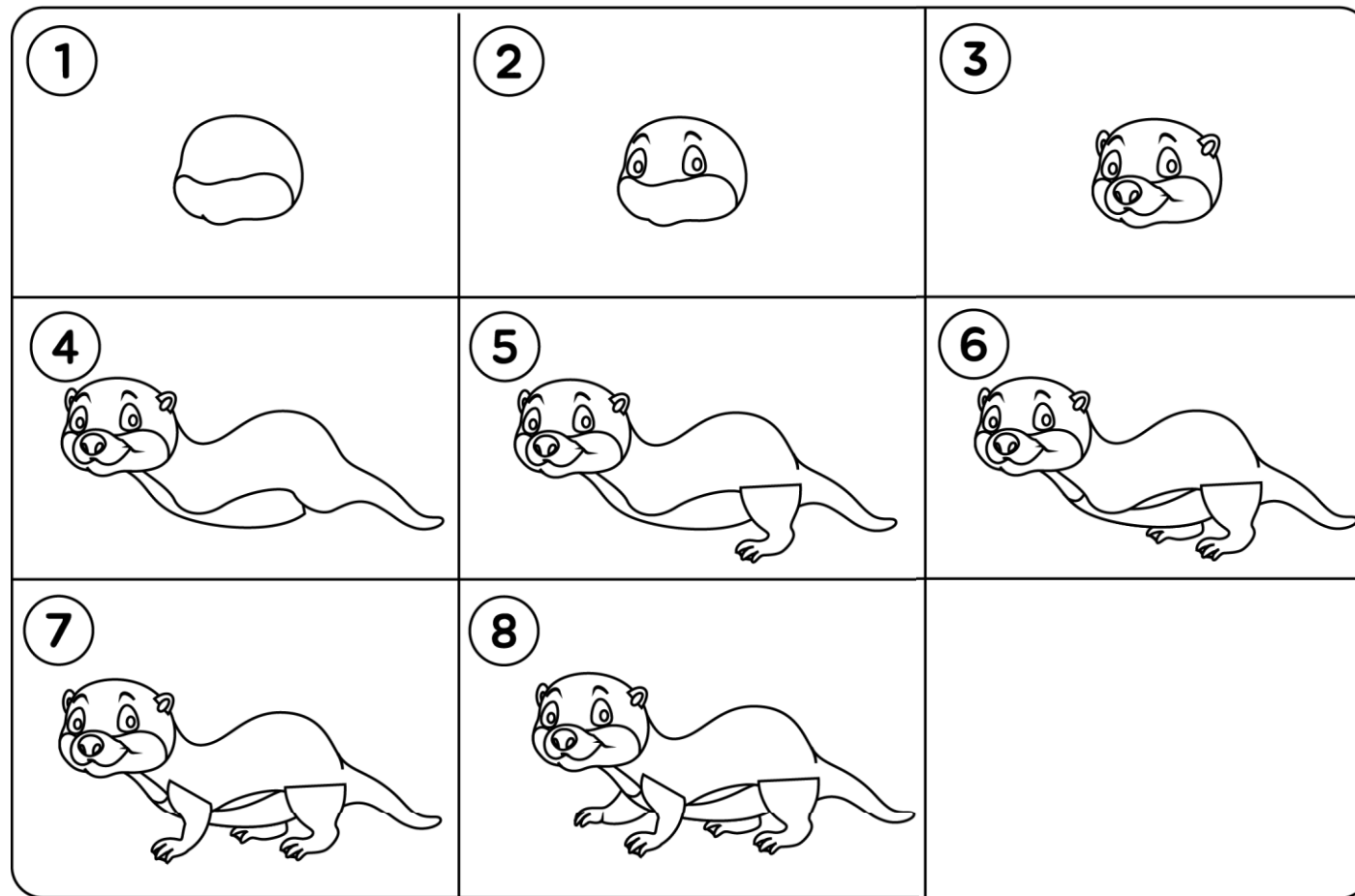

## Practice

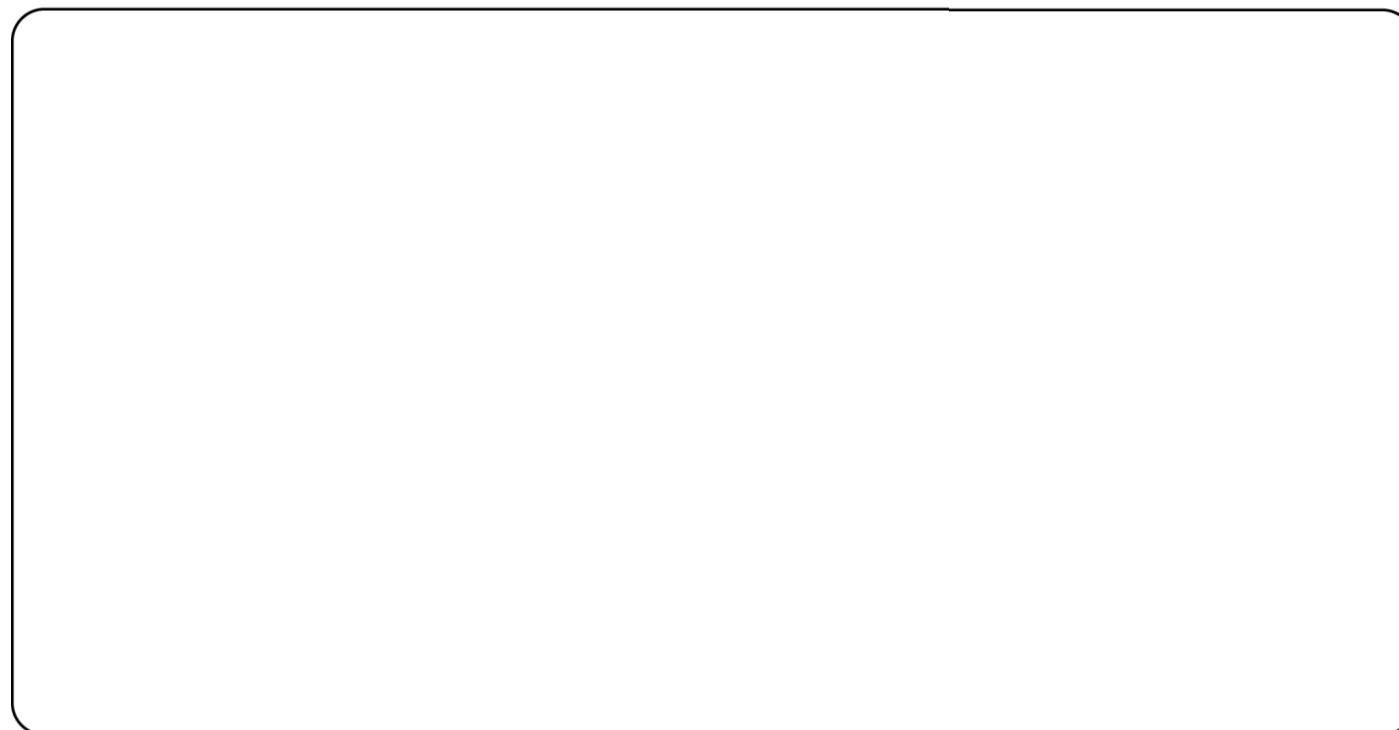

# Hamburger

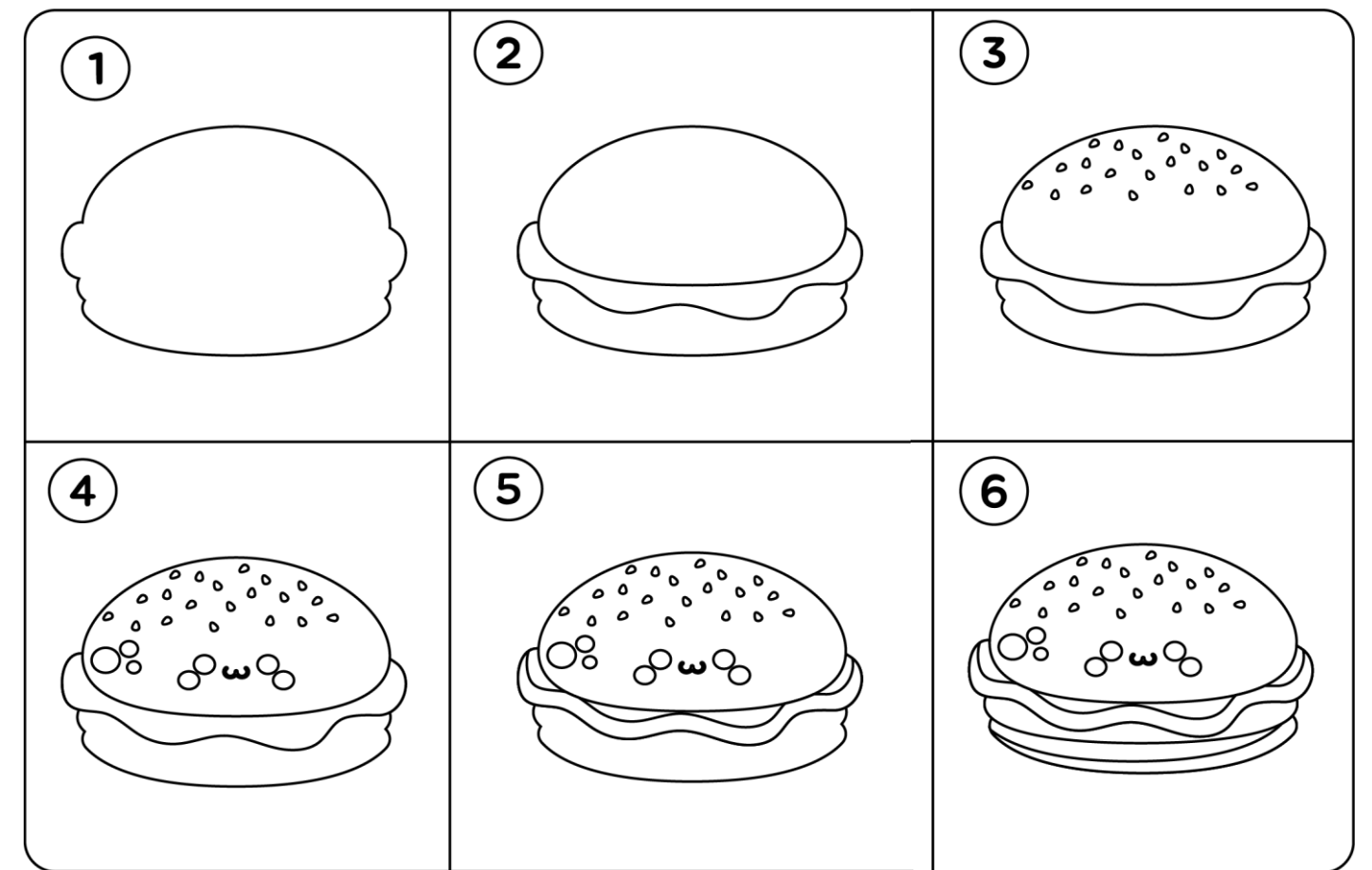

## Practice

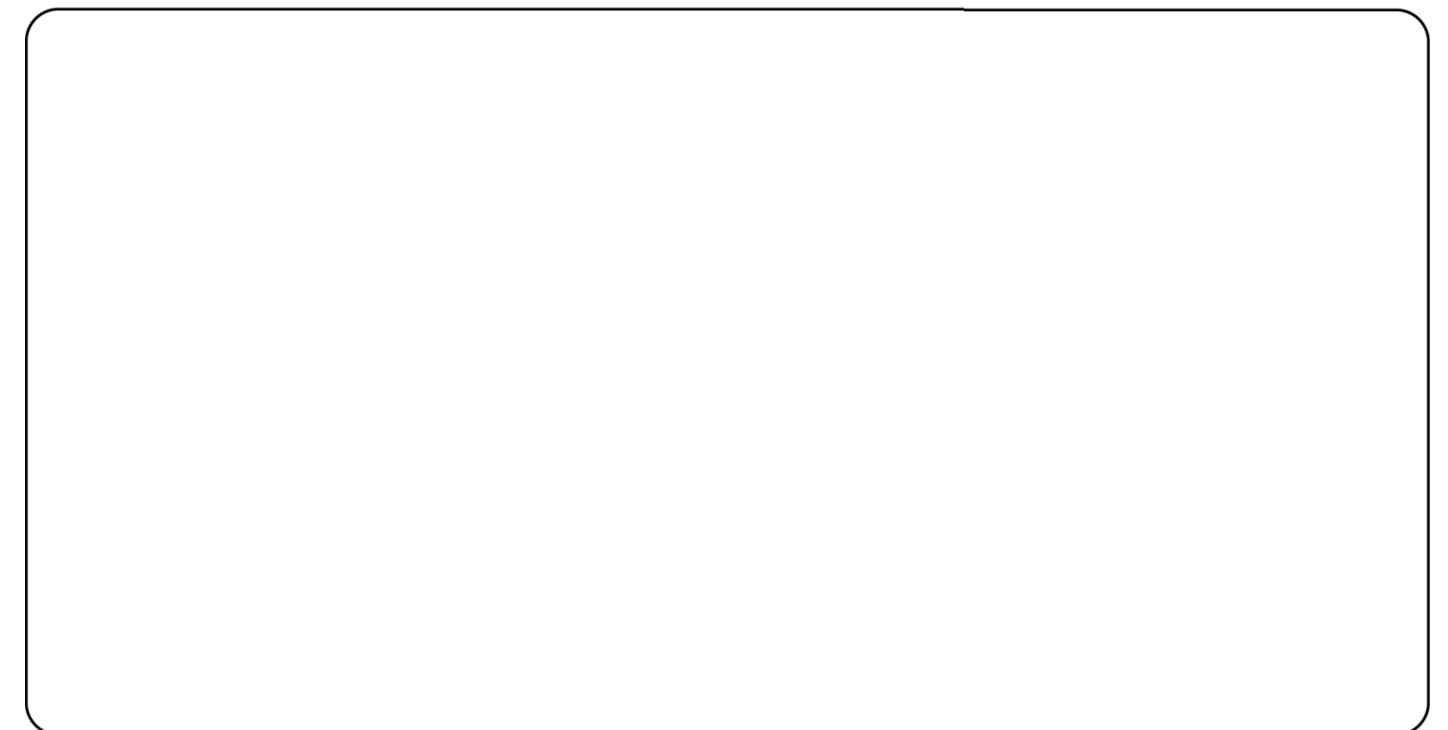

# Rat

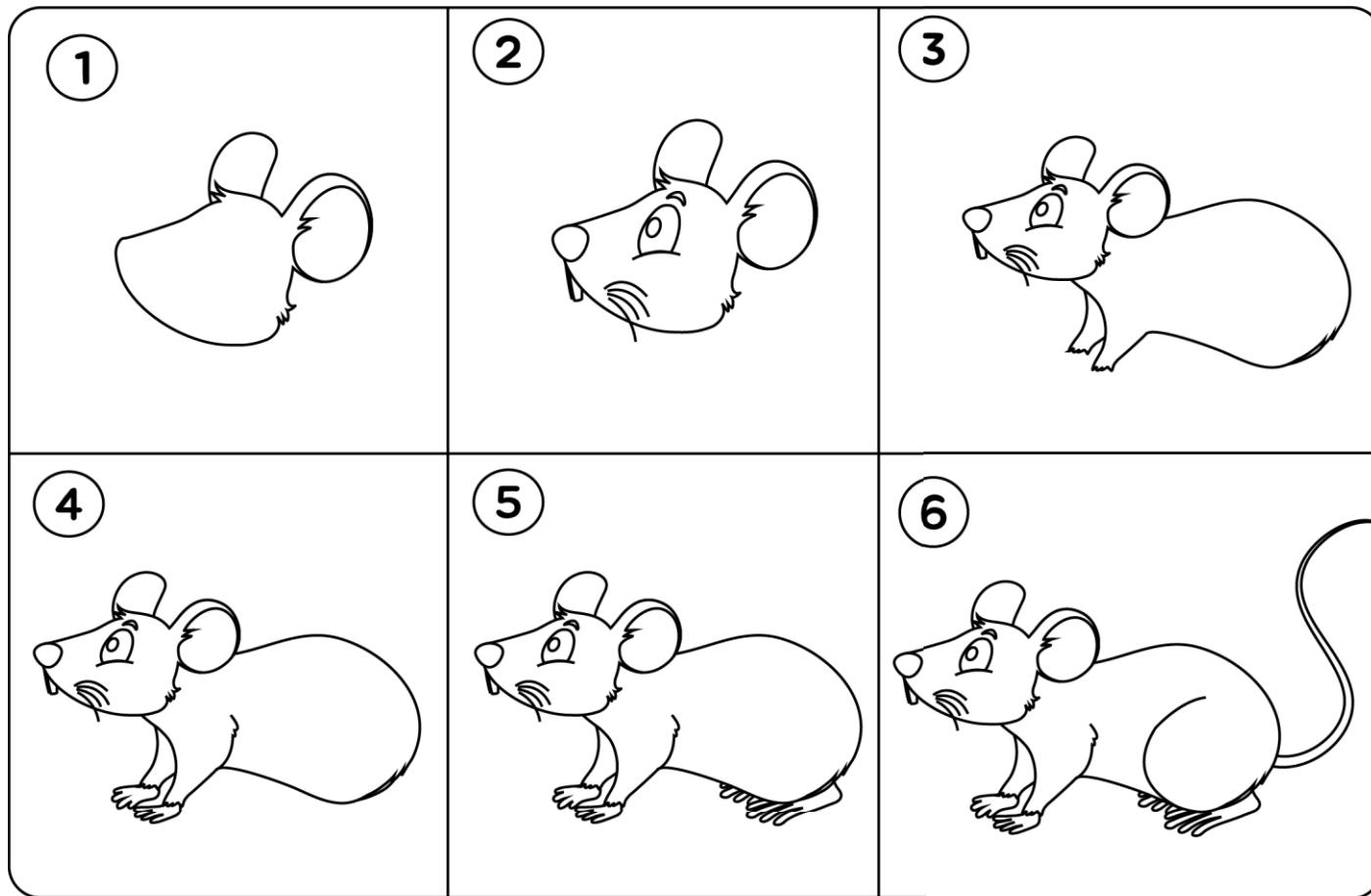

## Practice

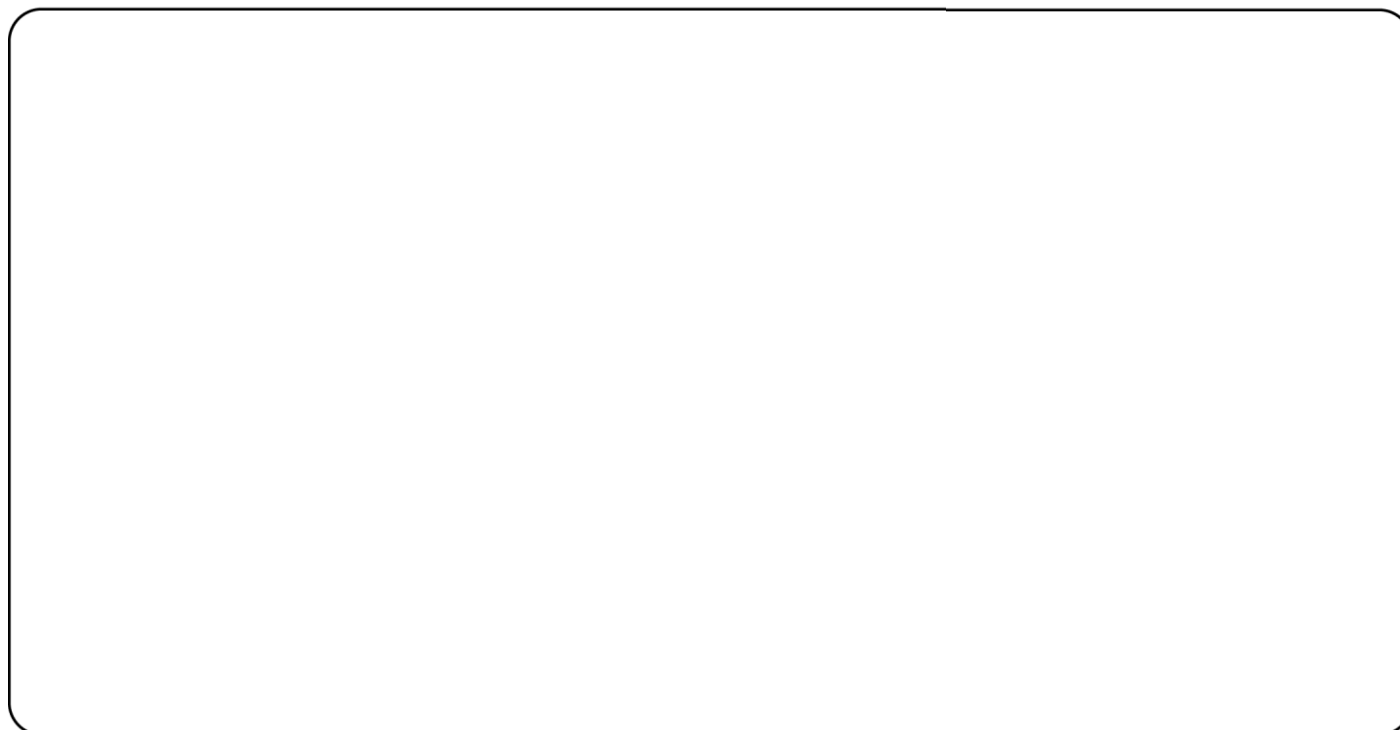

# Buffalo

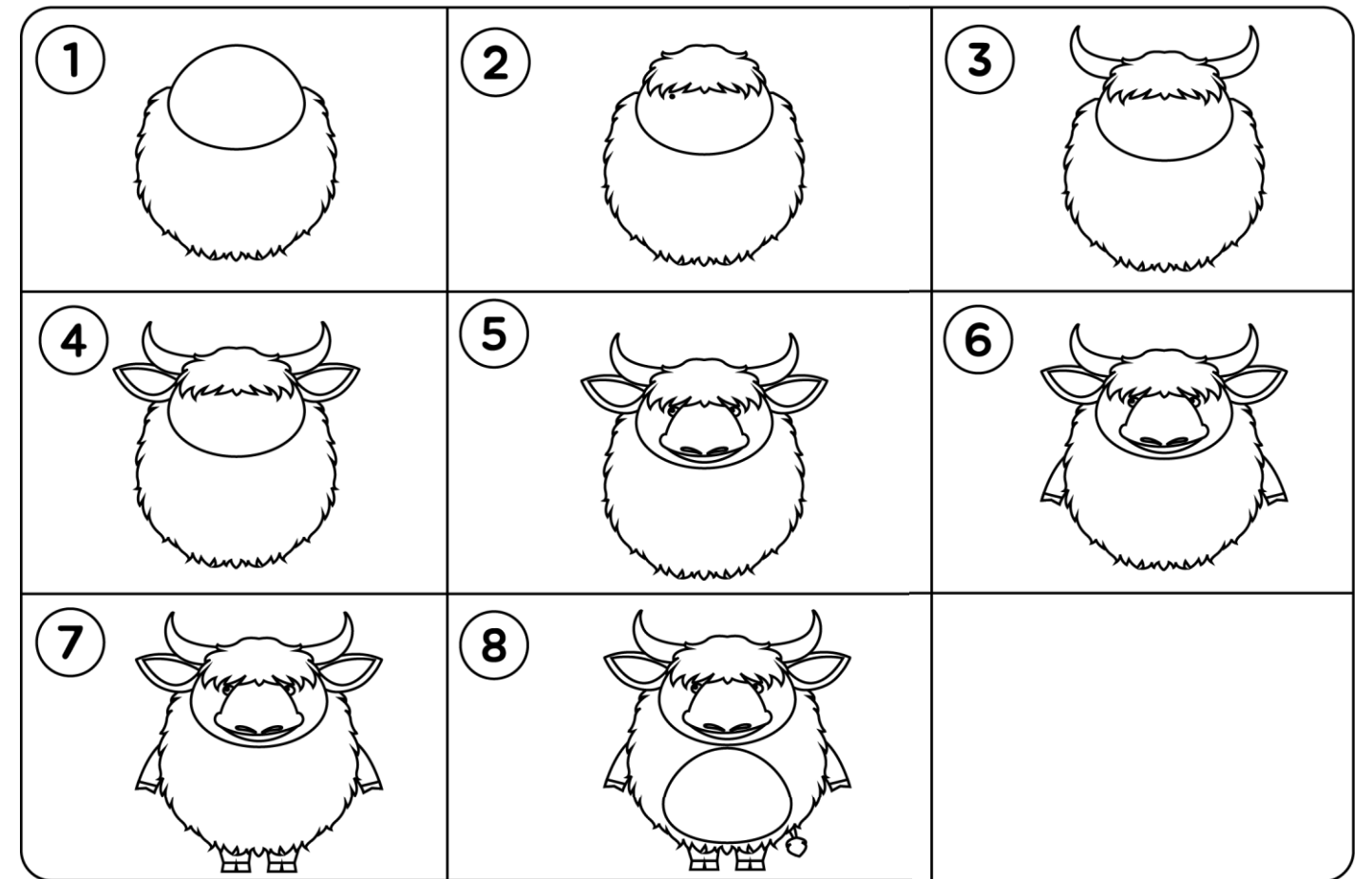

## Practice

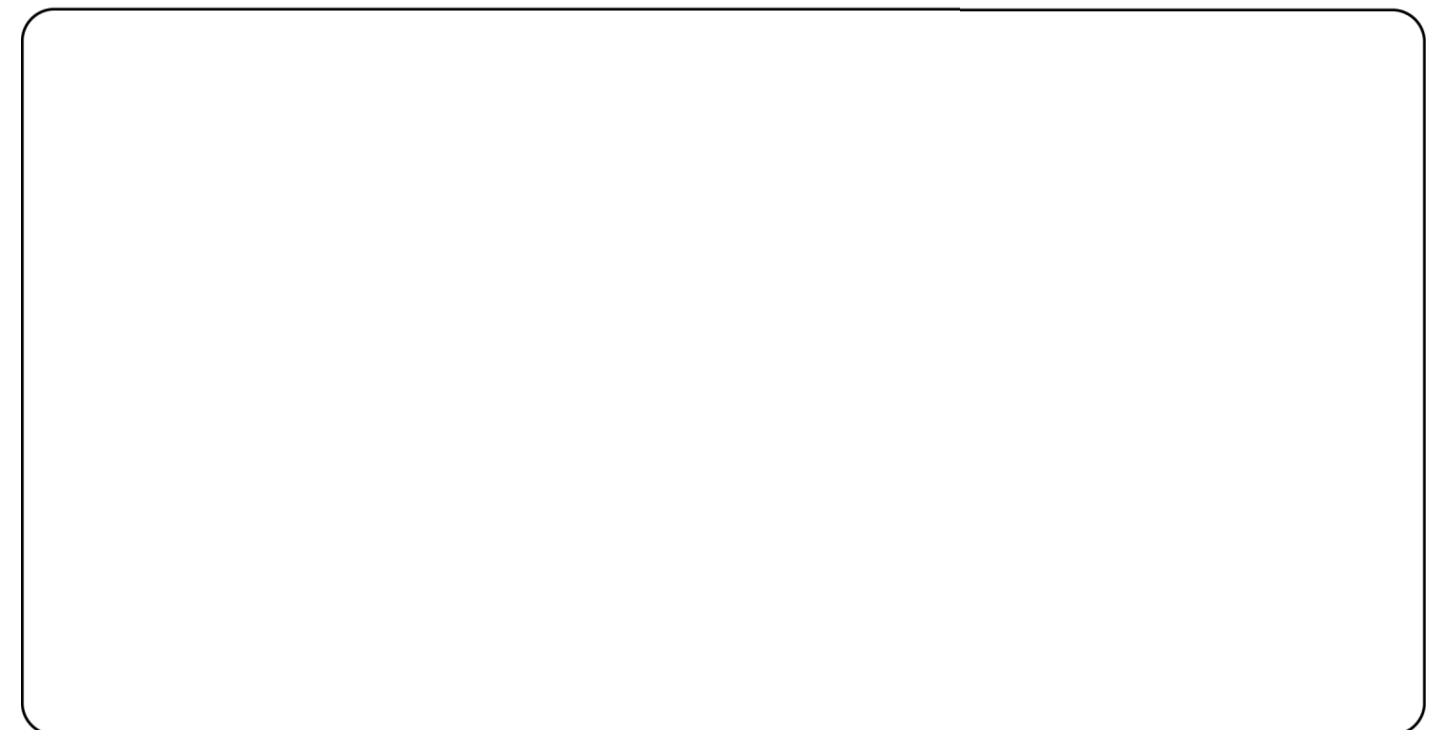

# Pumpkin House

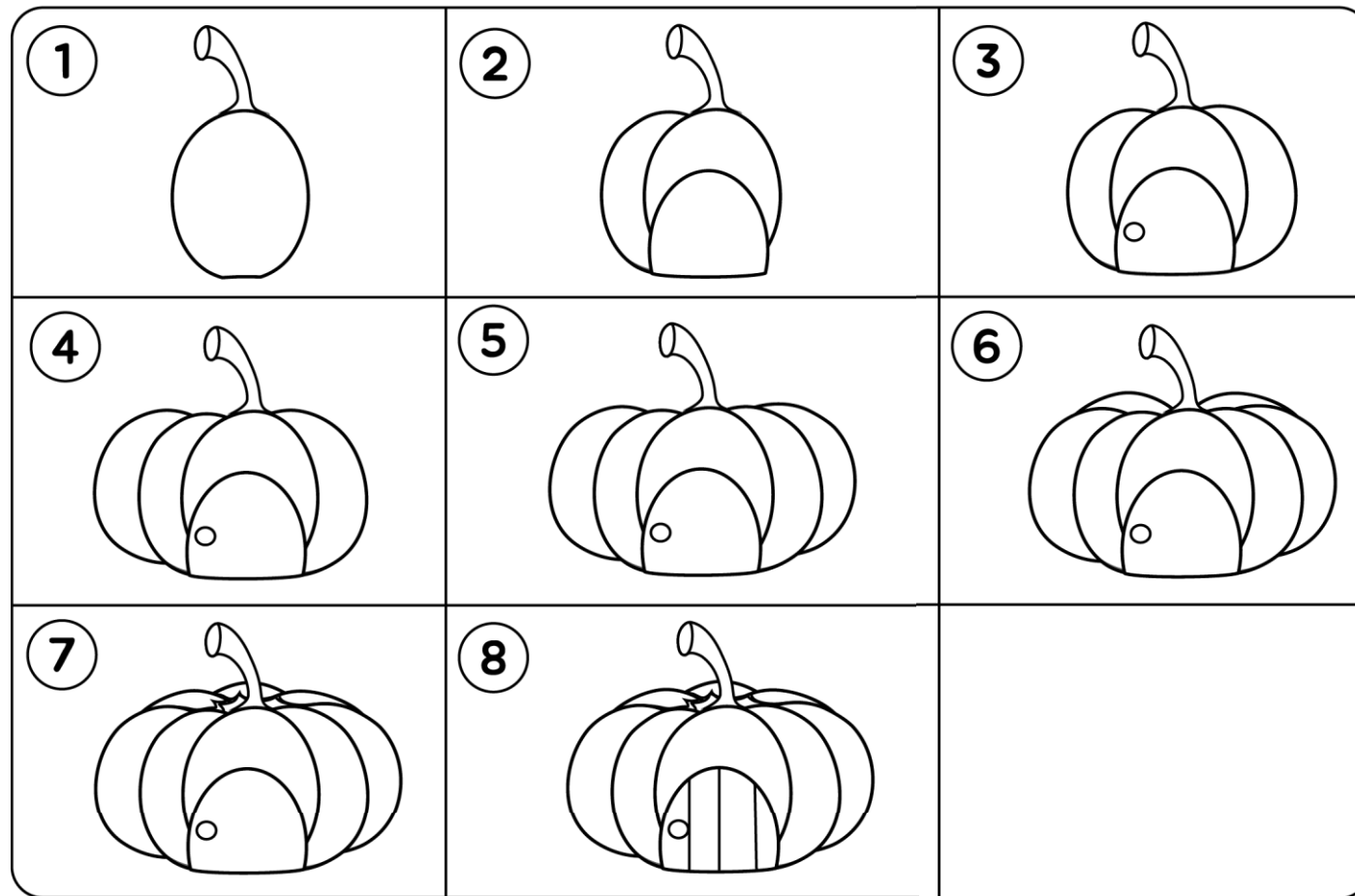

*Practice*

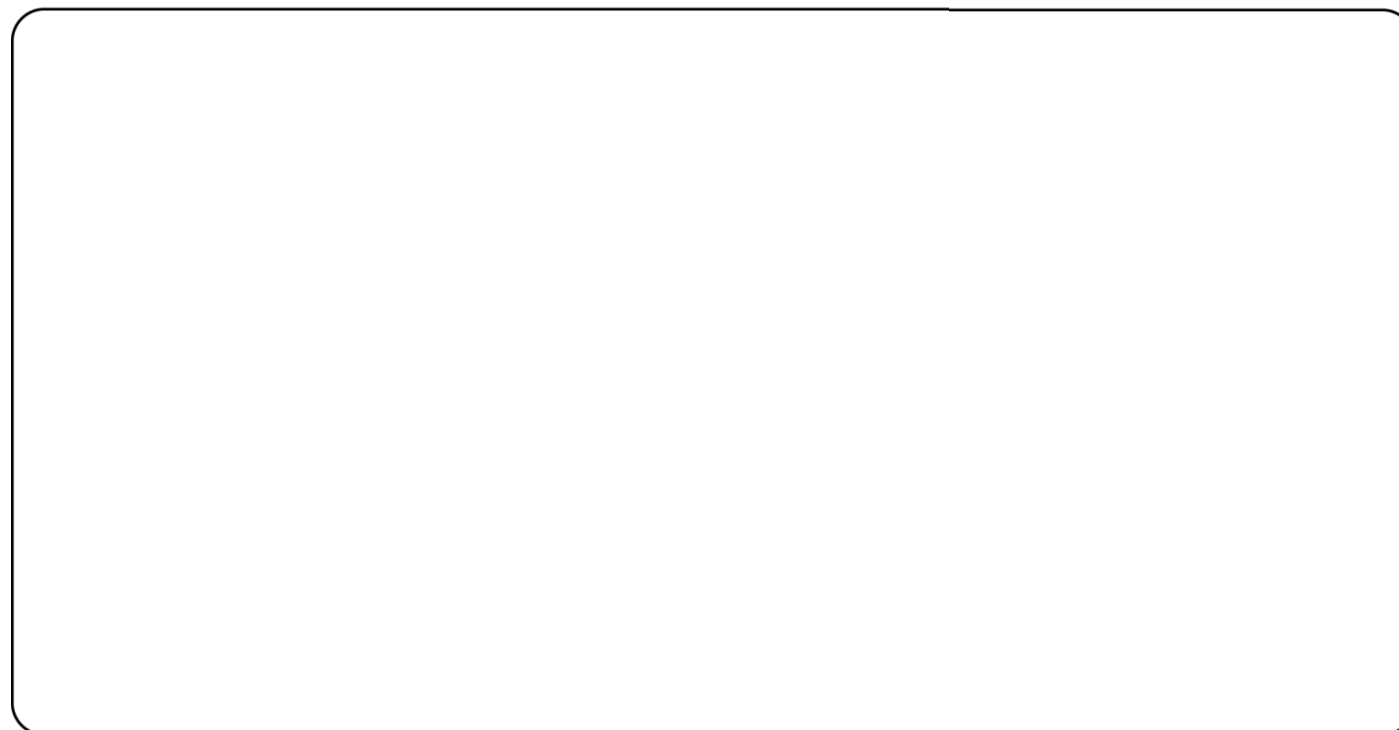

# Chameleon

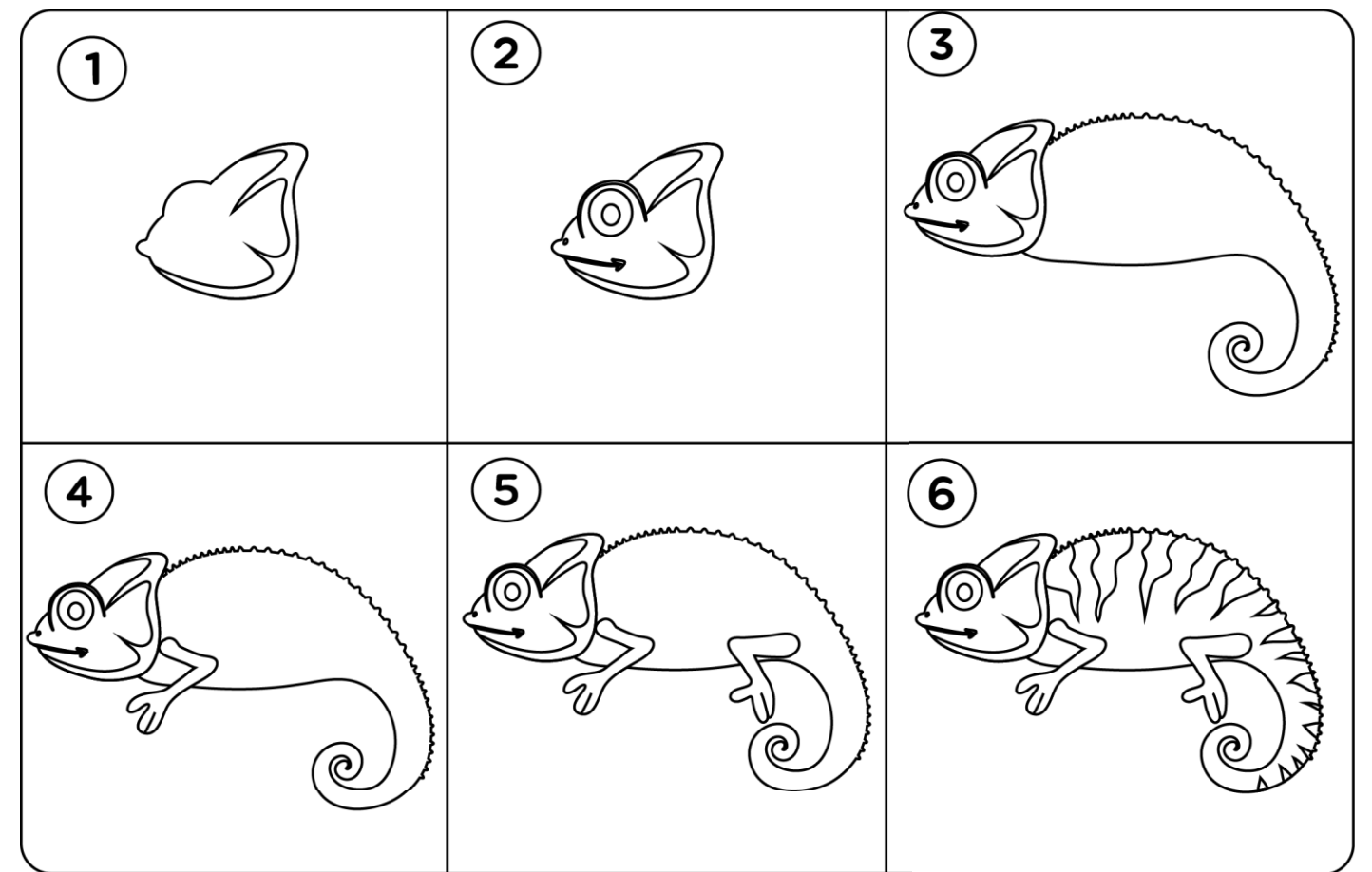

*Practice*

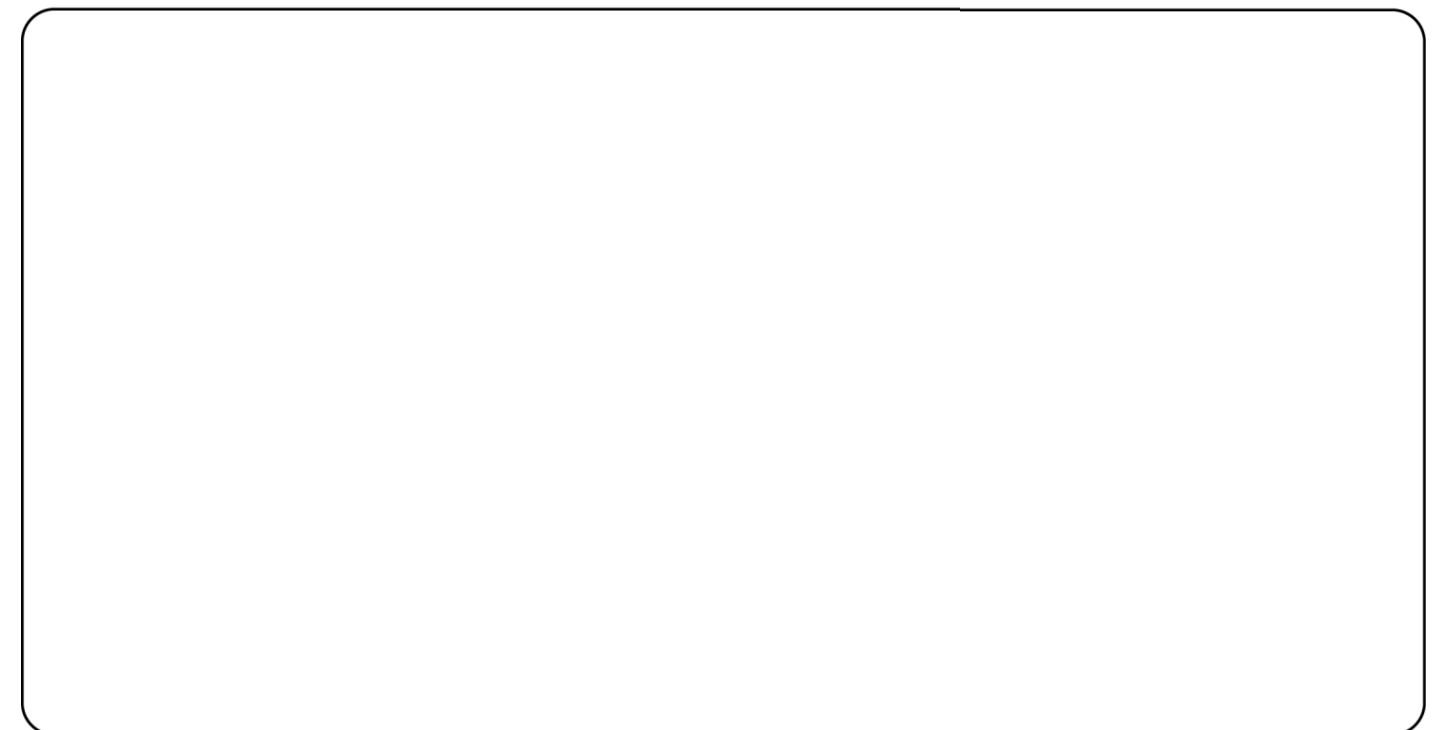

# Lemur Mouse

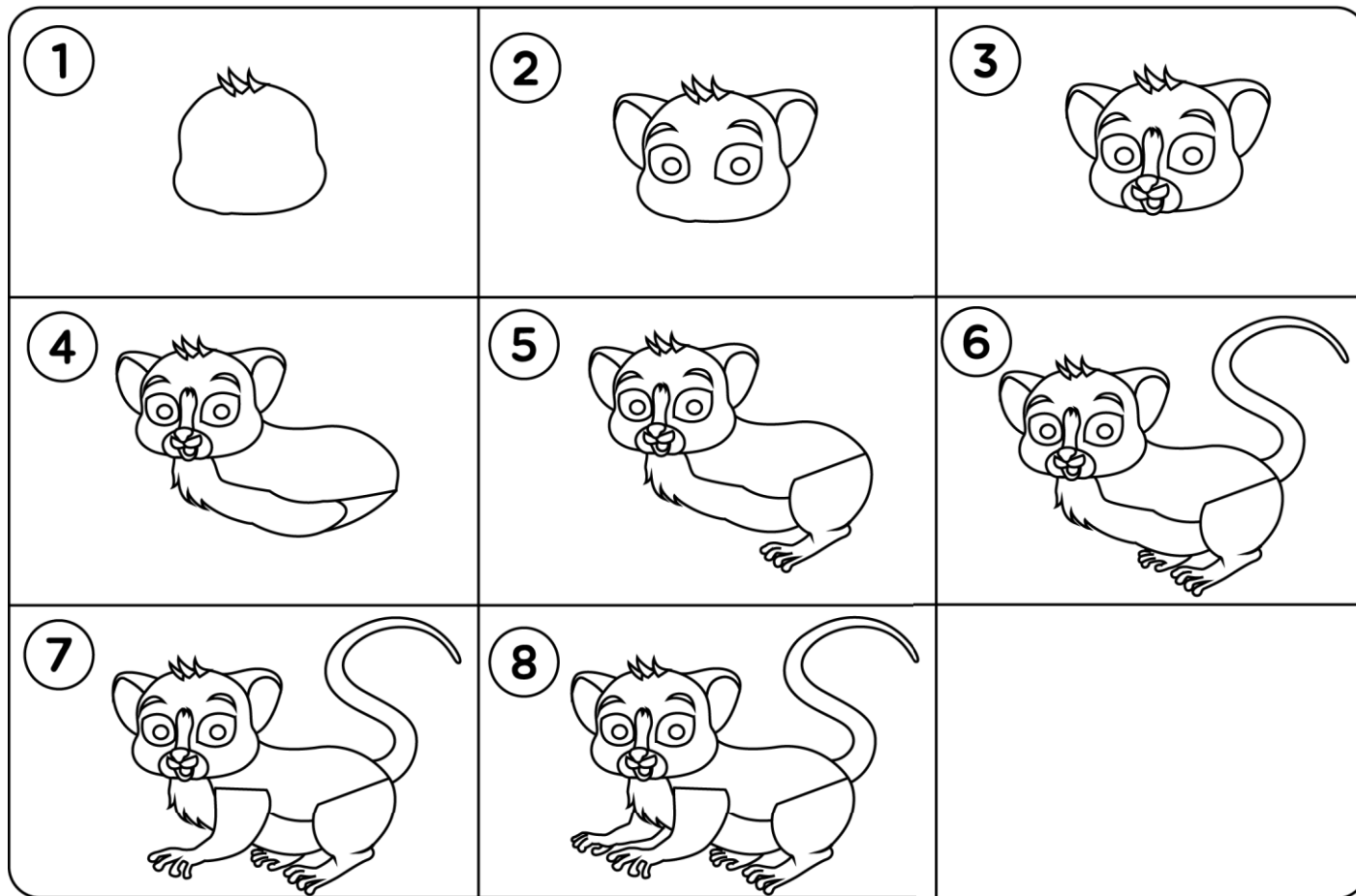

## Practice

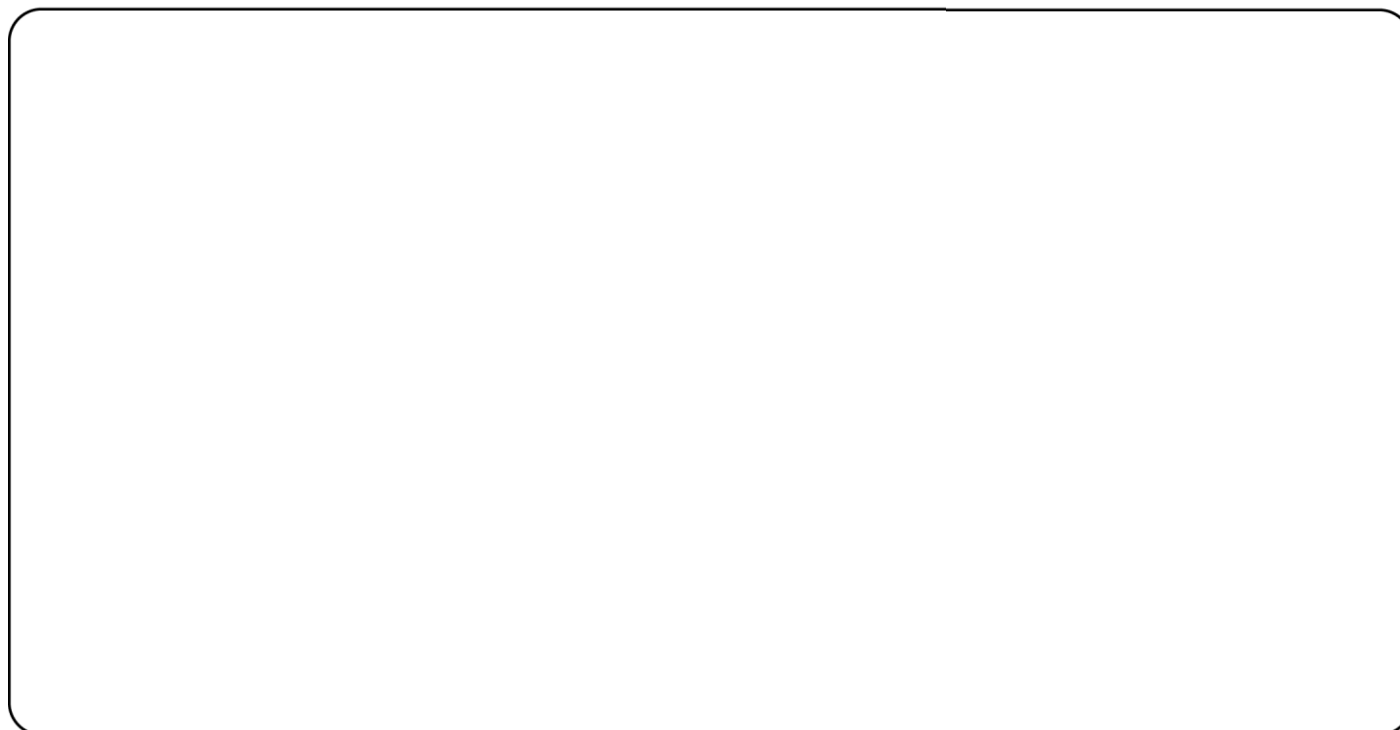

# Beetle

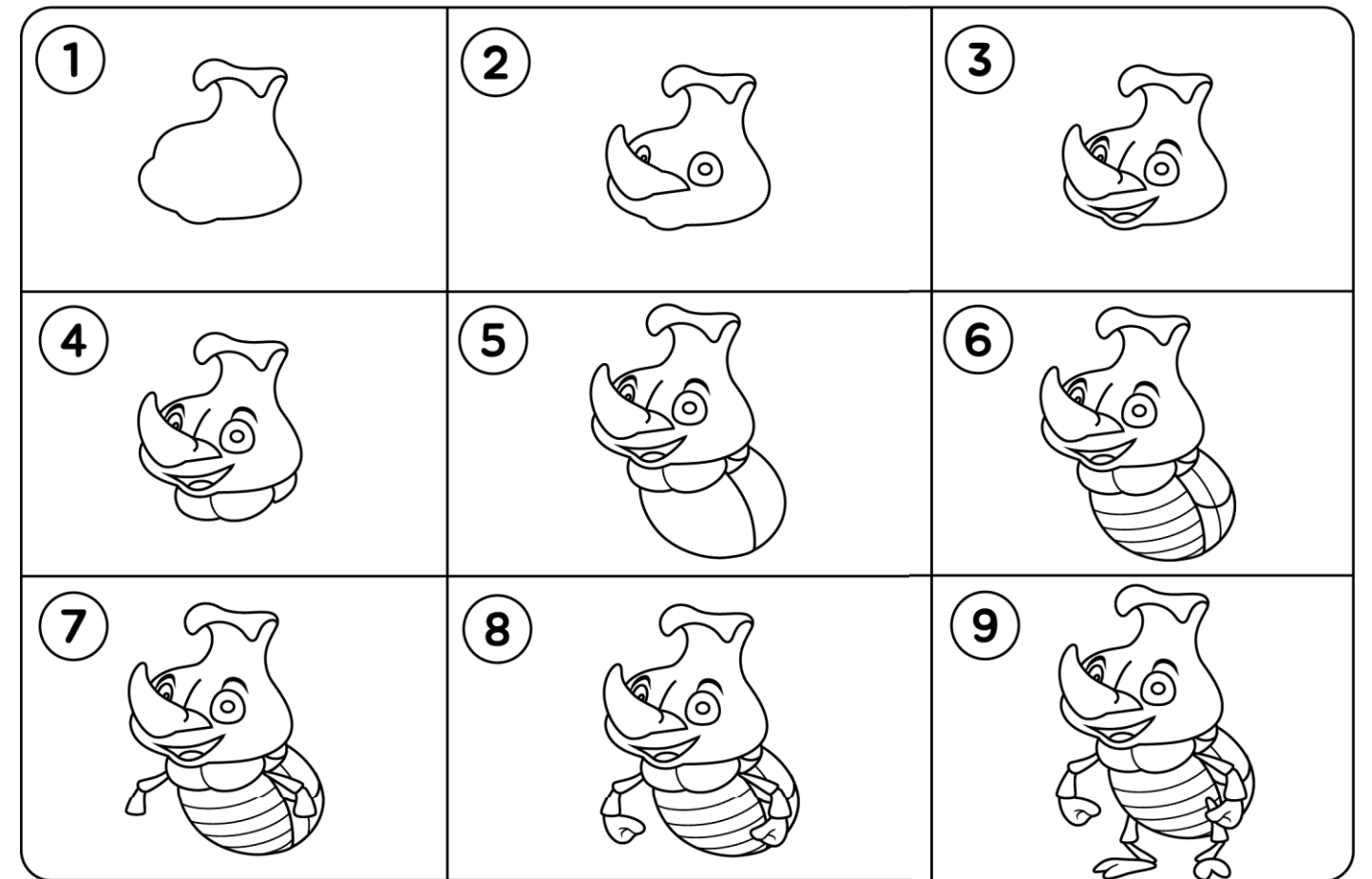

## Practice

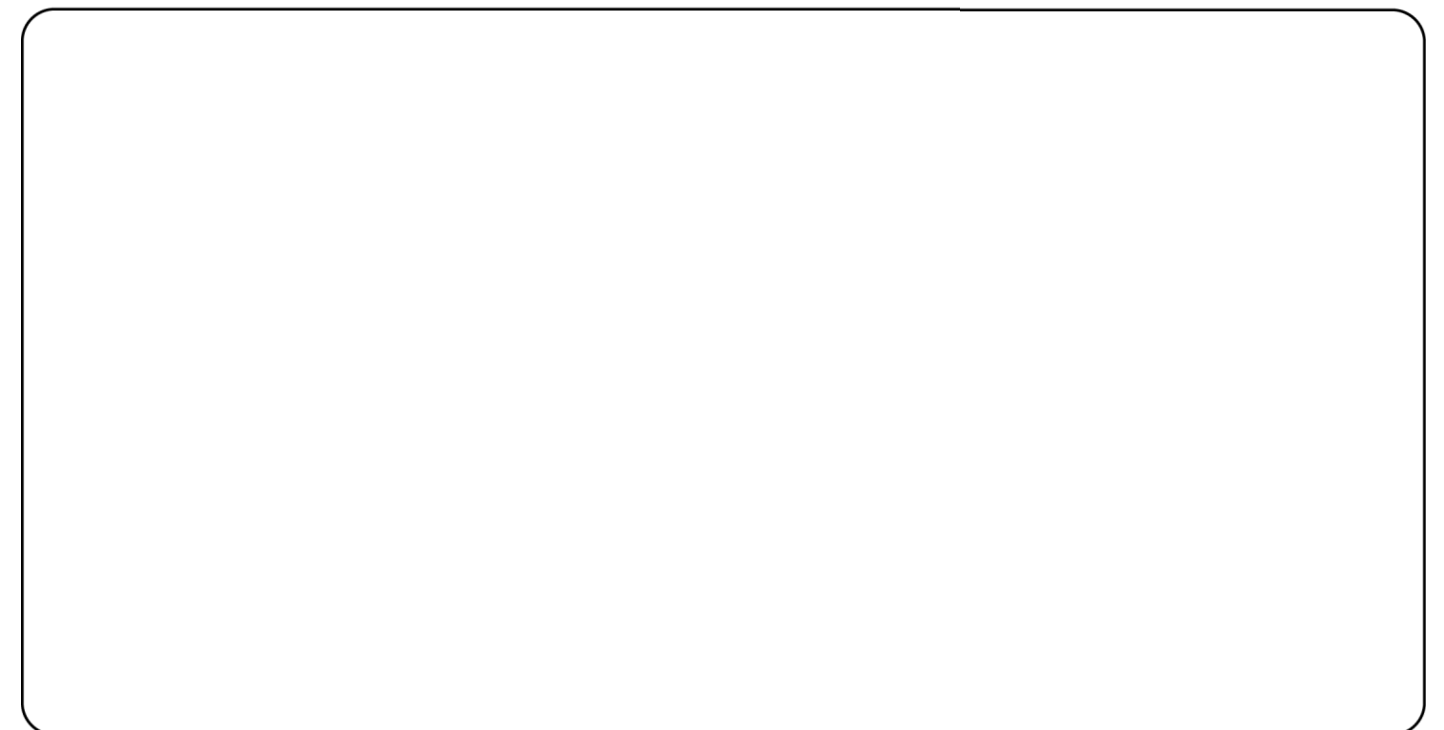

# Cactus

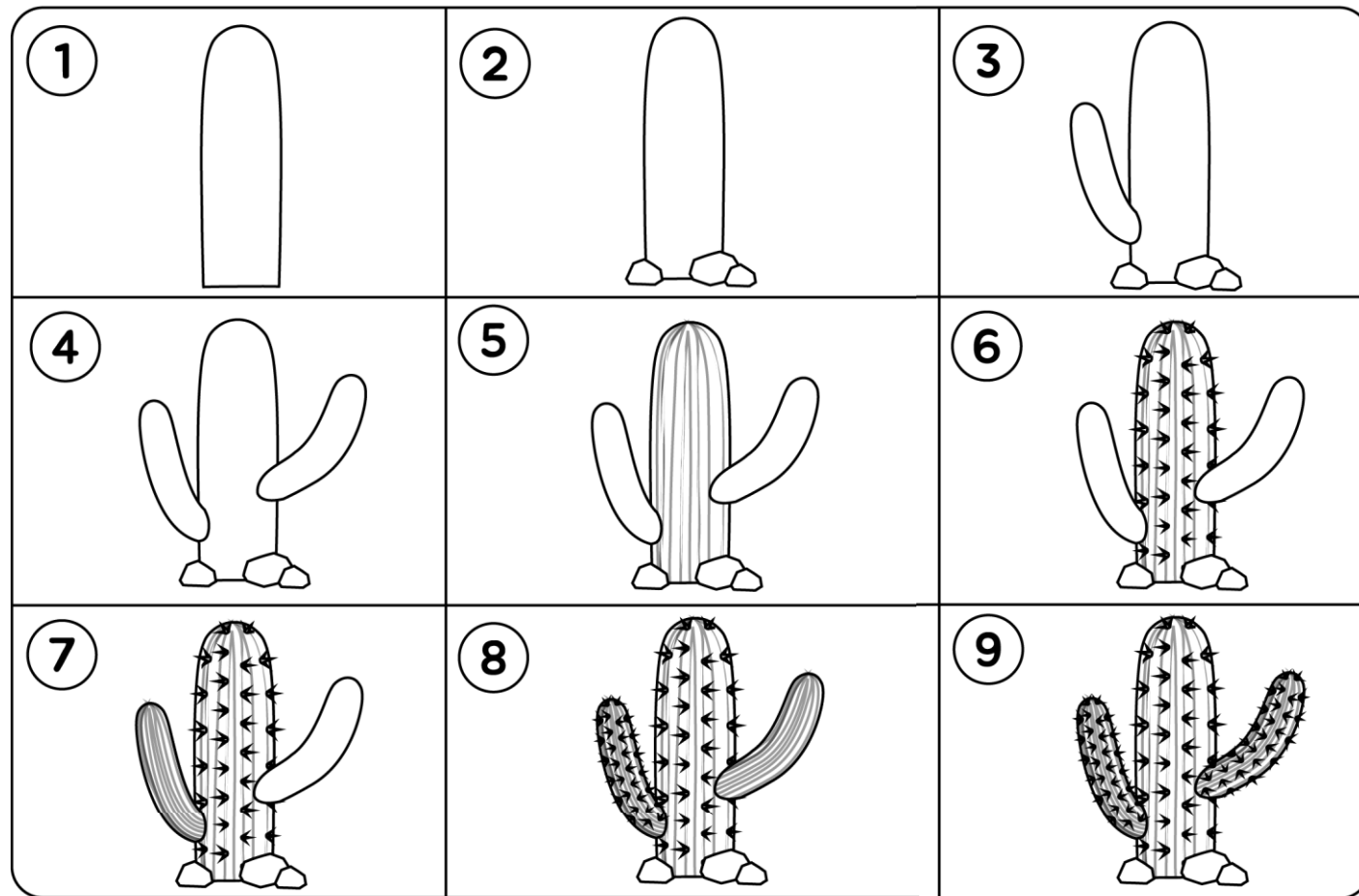

## Practice

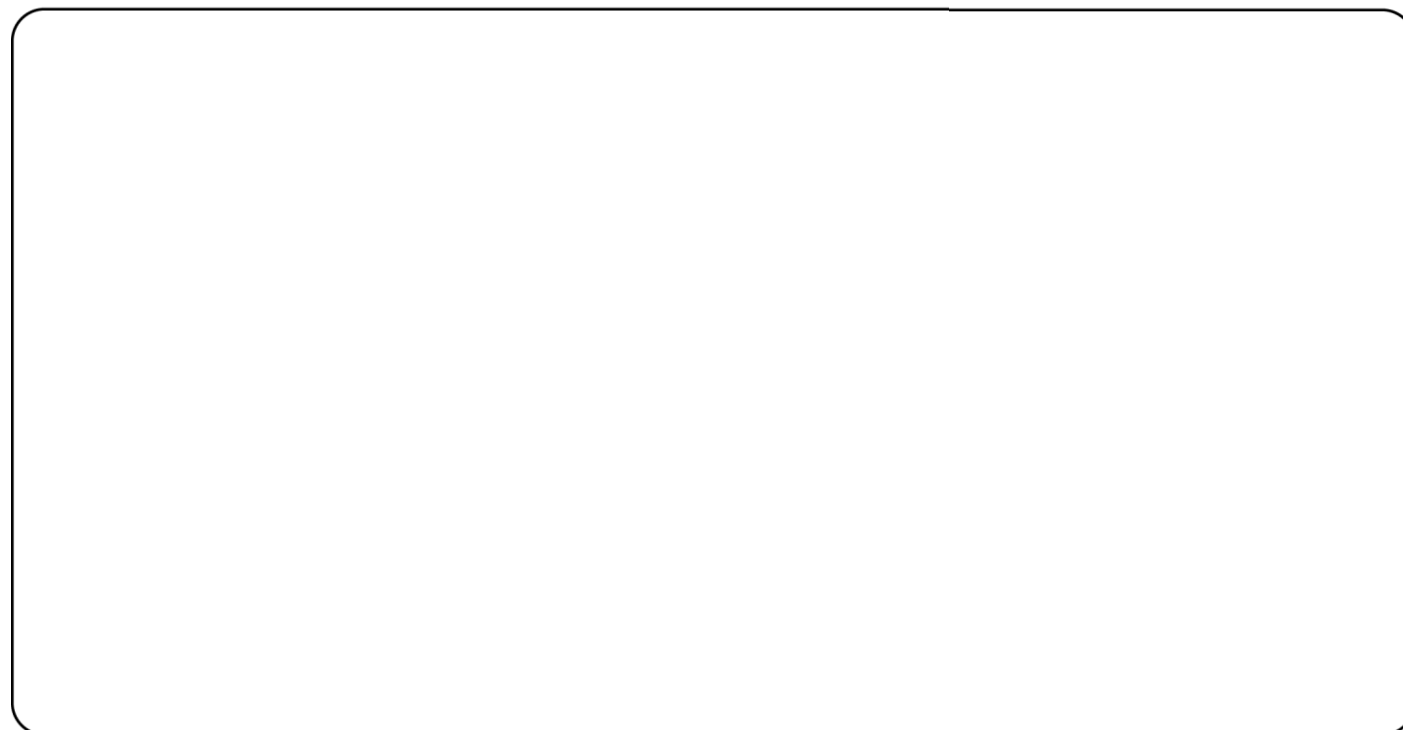

# Butterfly

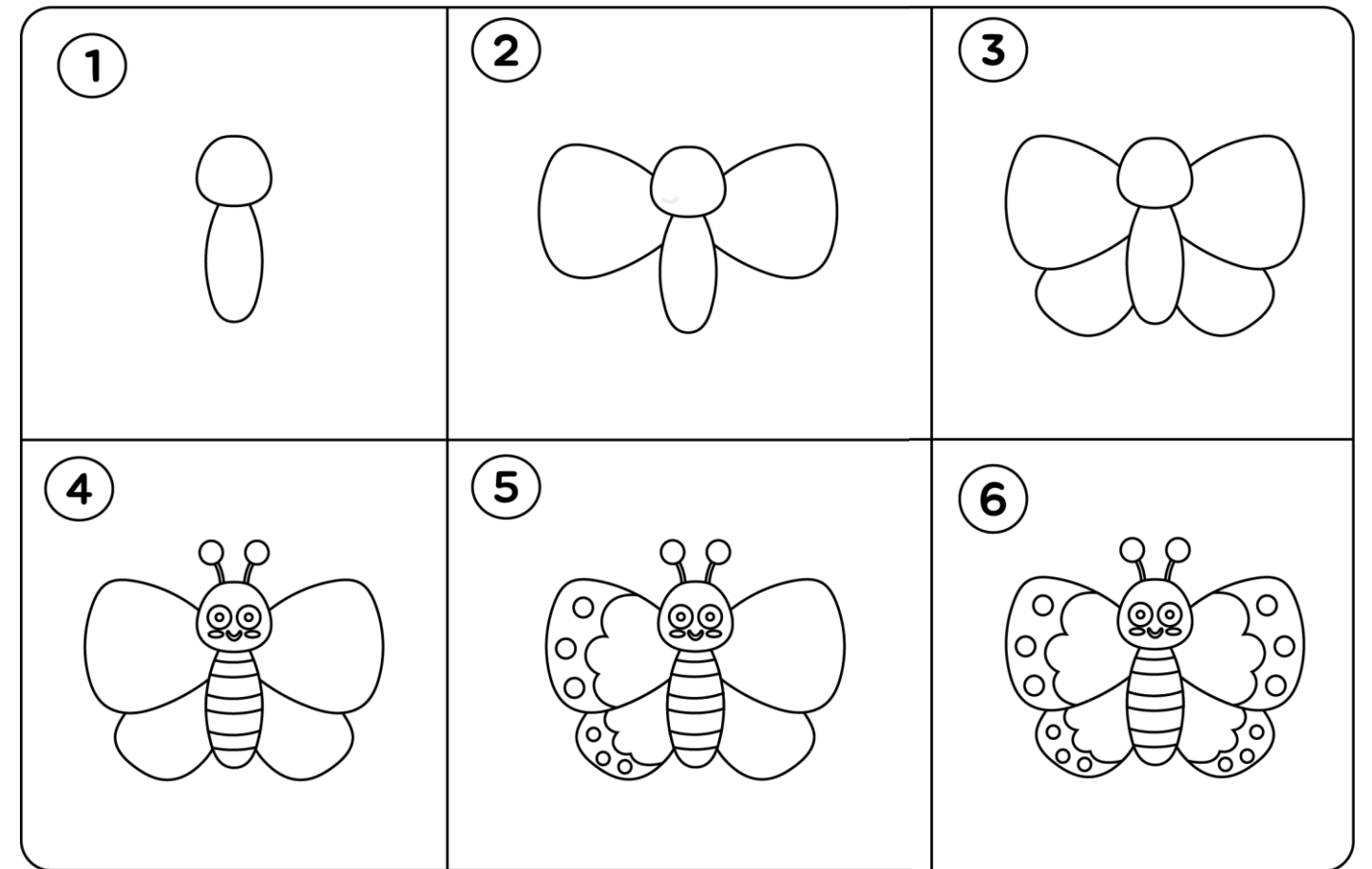

## Practice

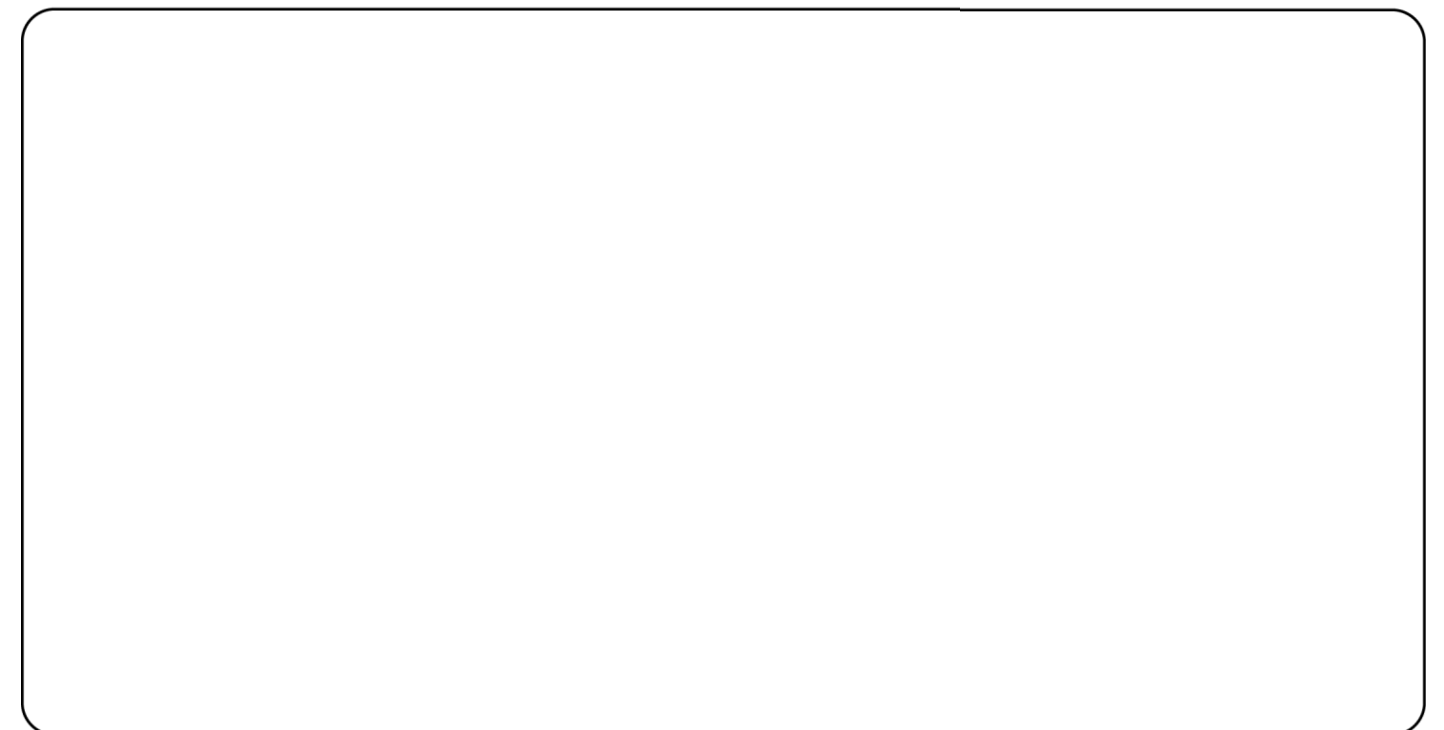

# Llama

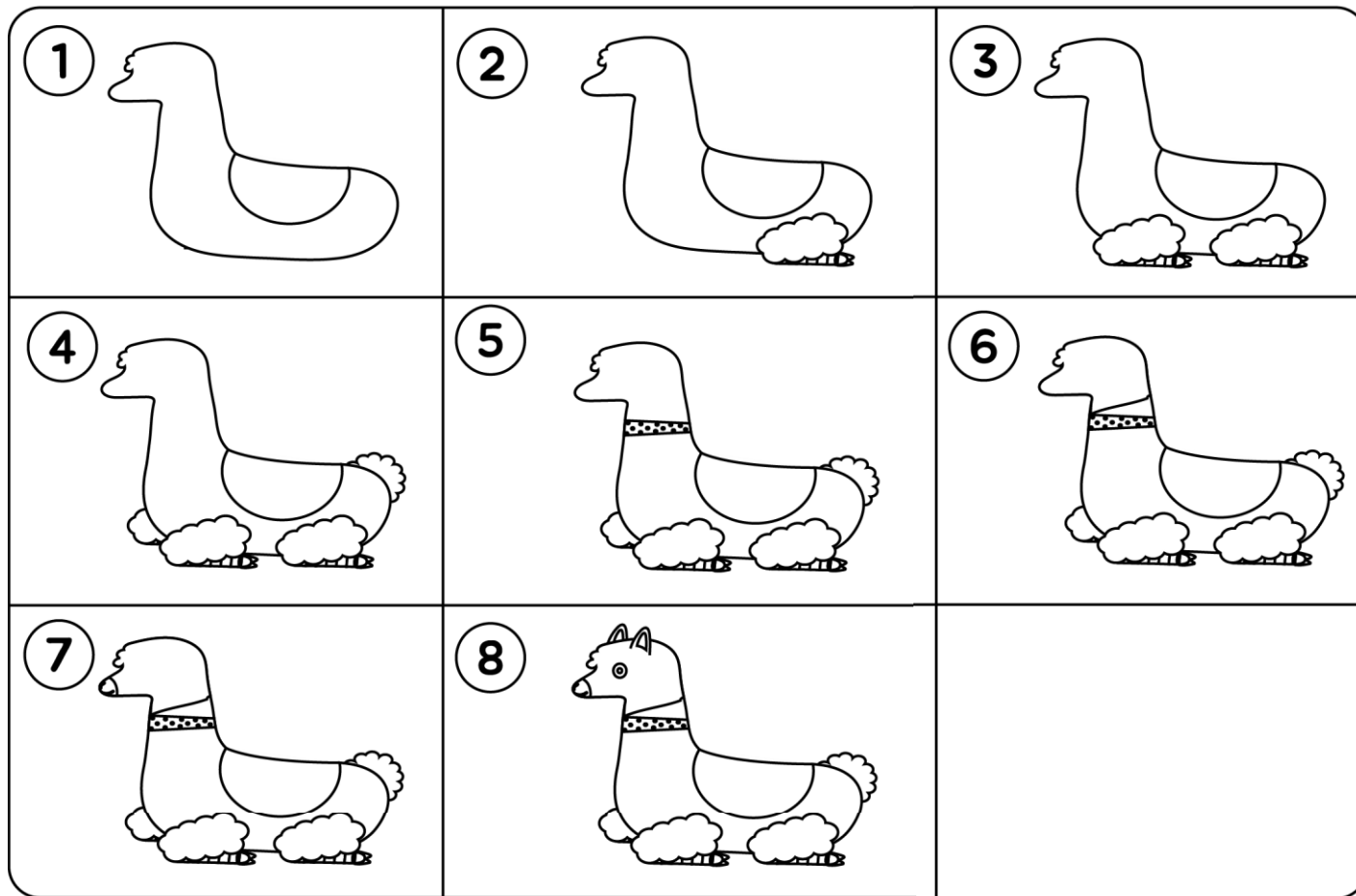

## Practice

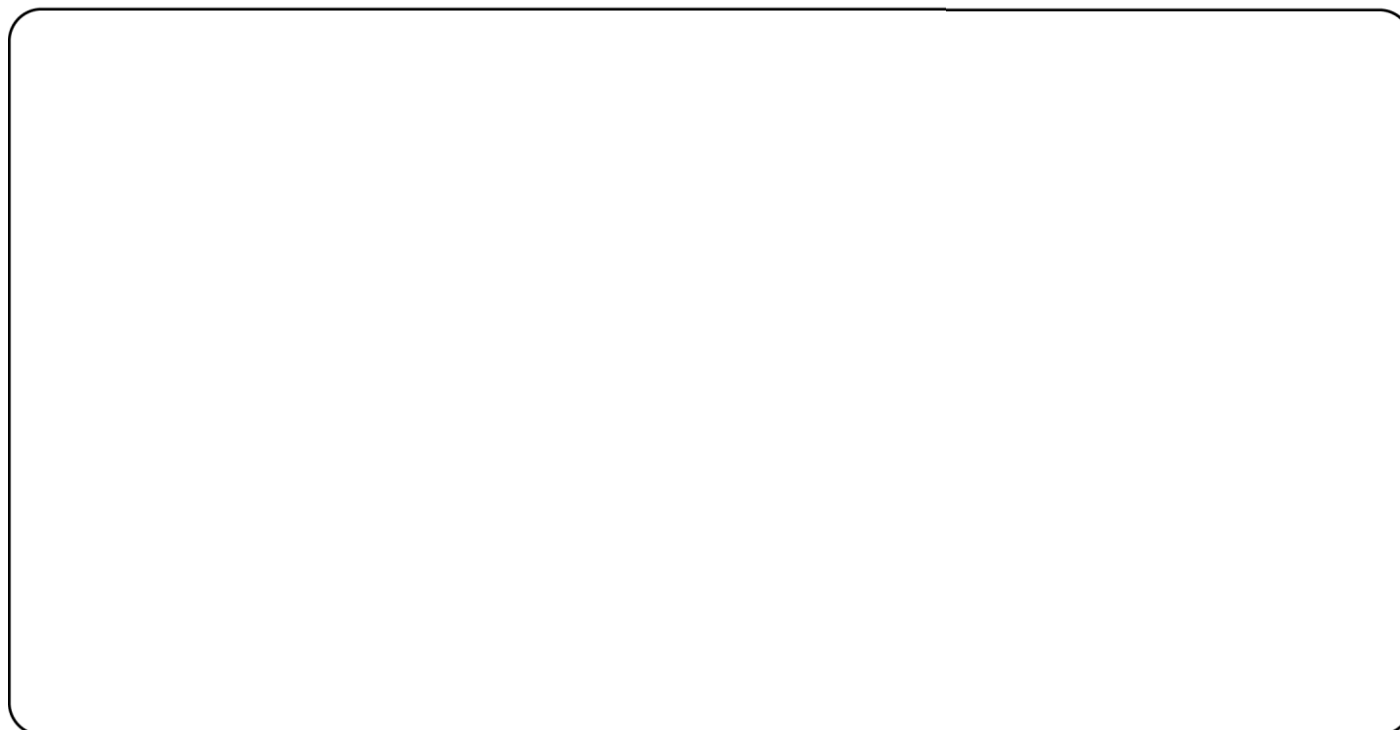

# Cake

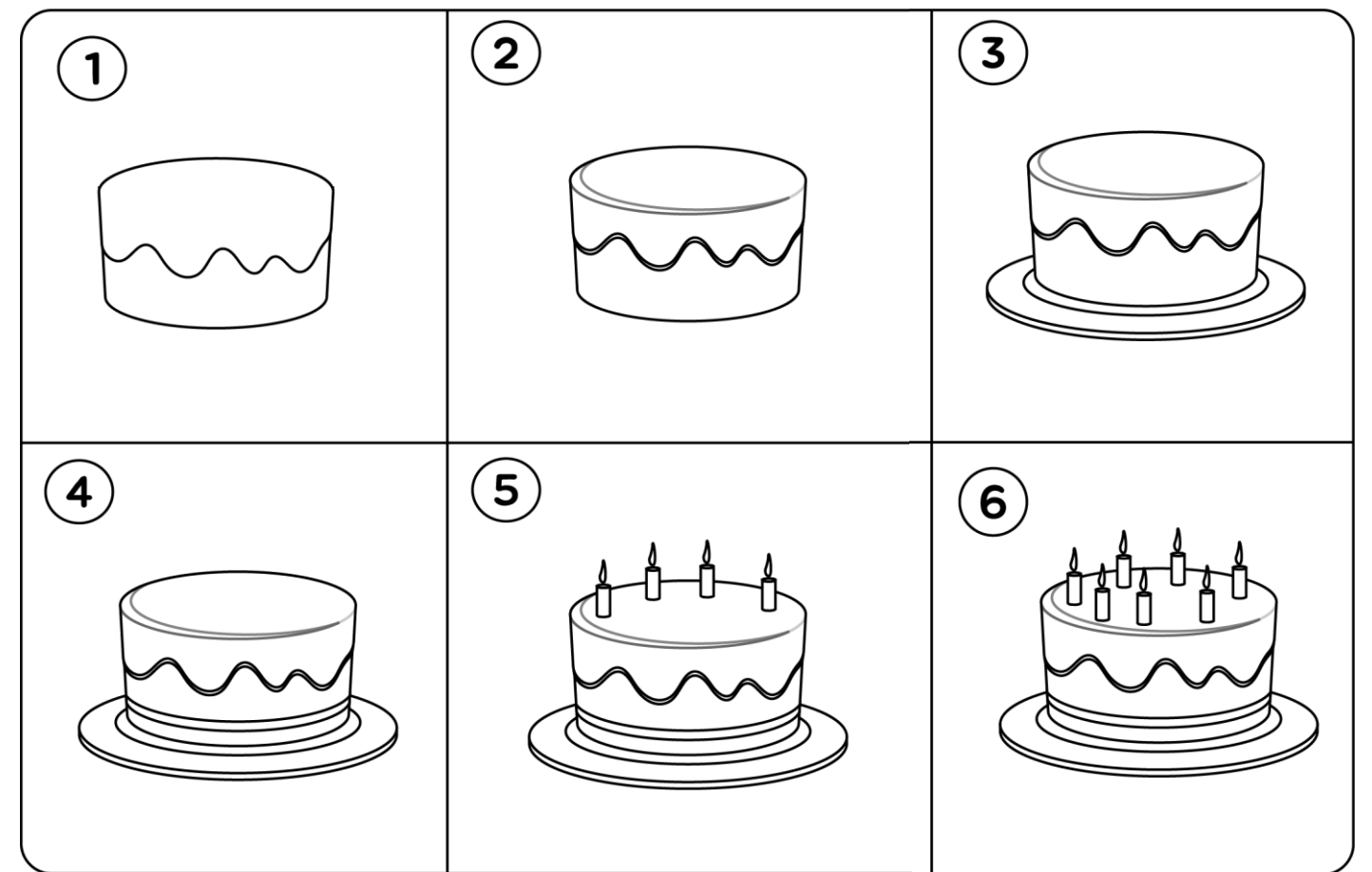

## Practice

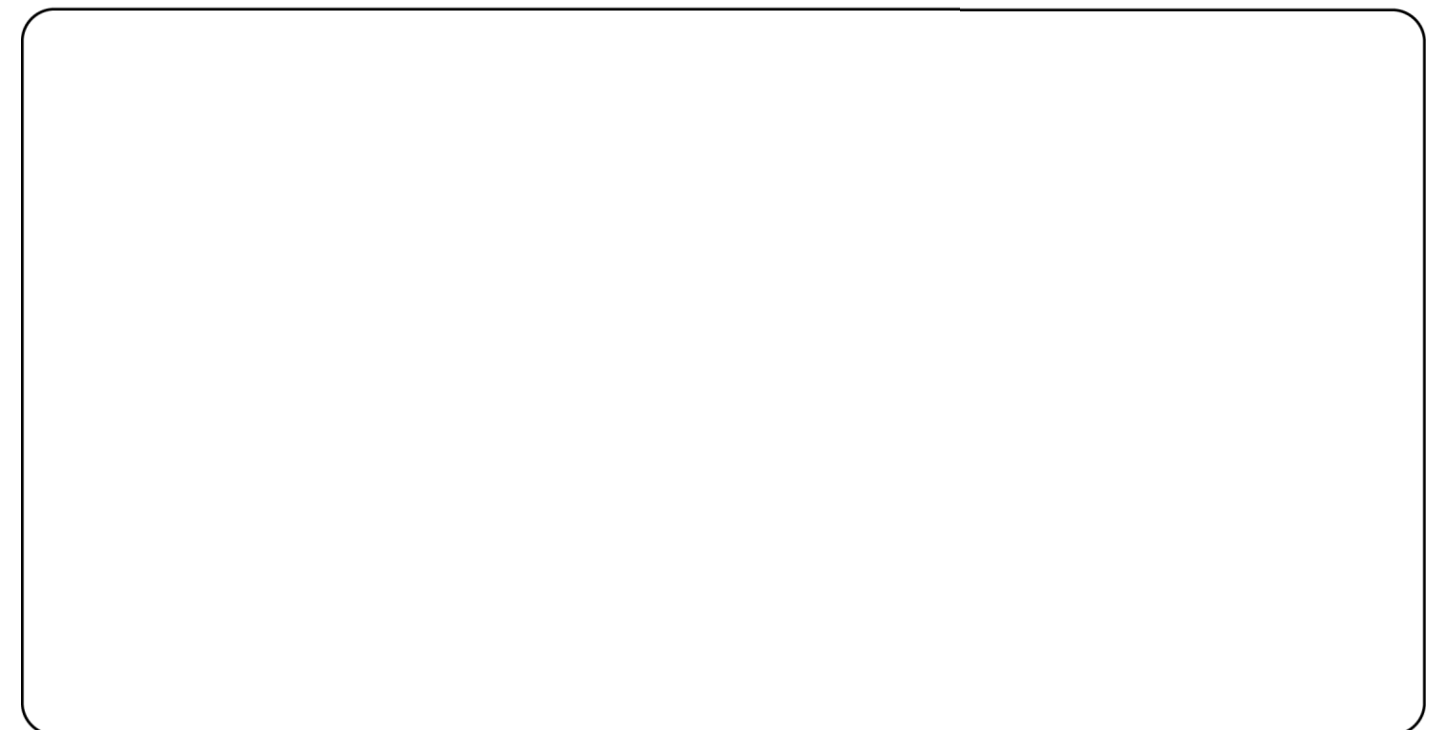

# Zebra

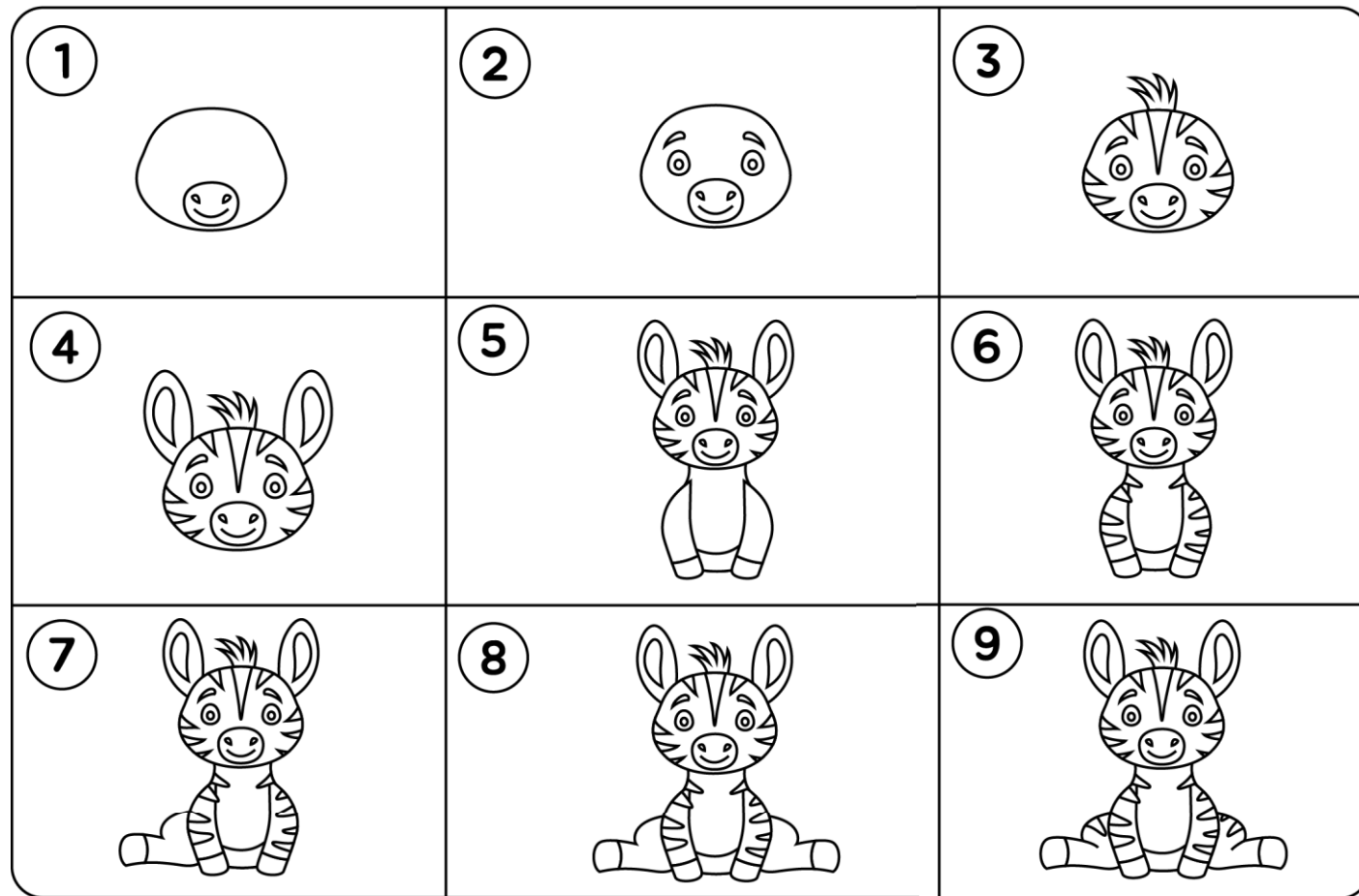

## Practice

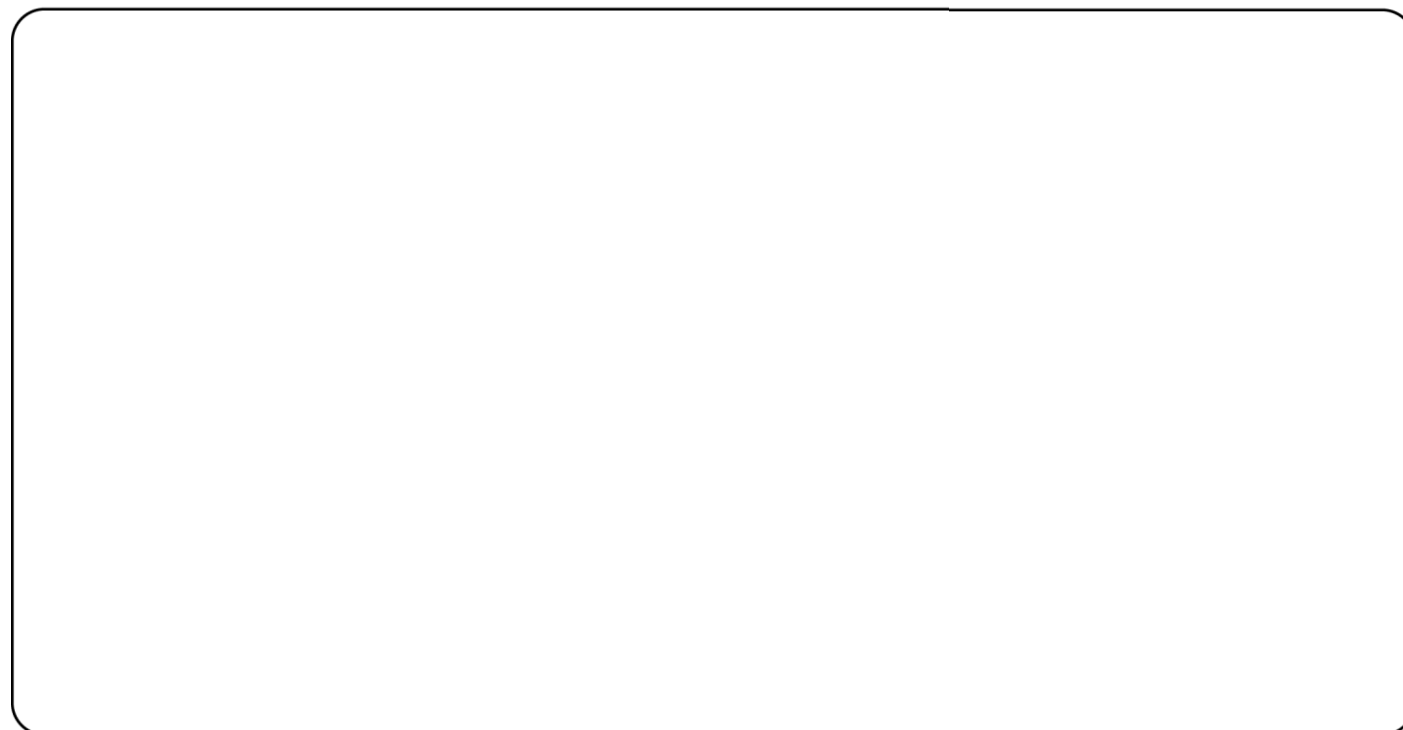

# Skull

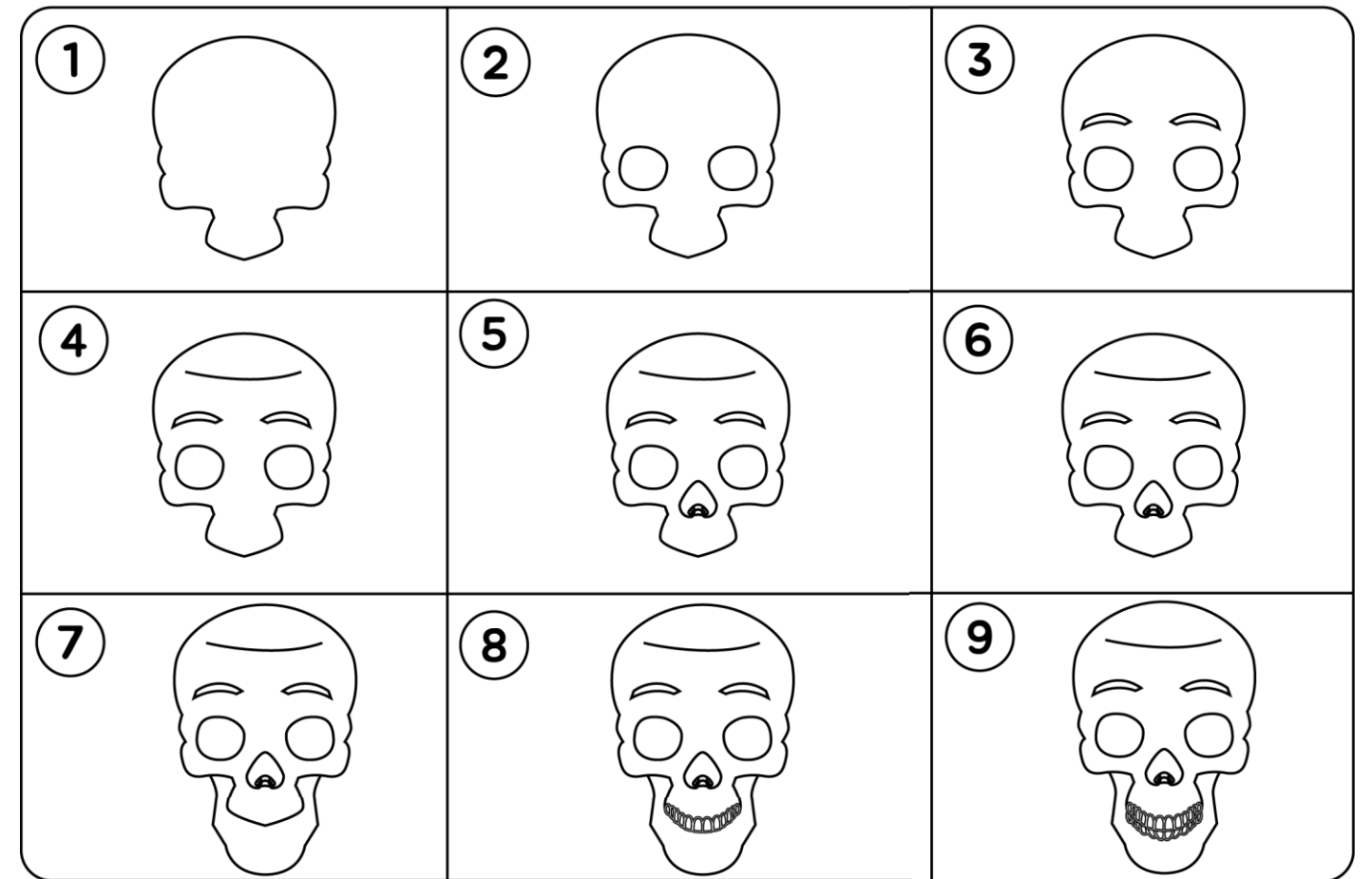

## Practice

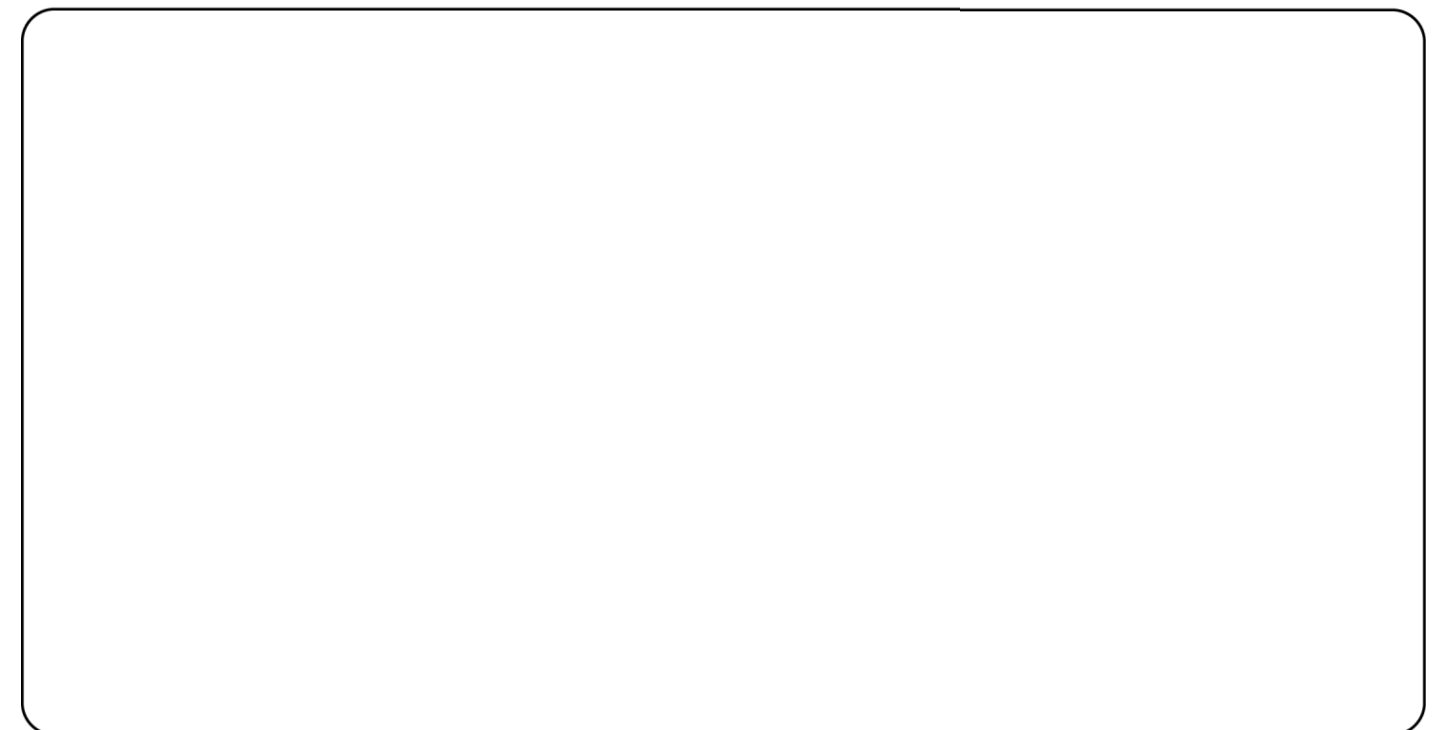

# Camel

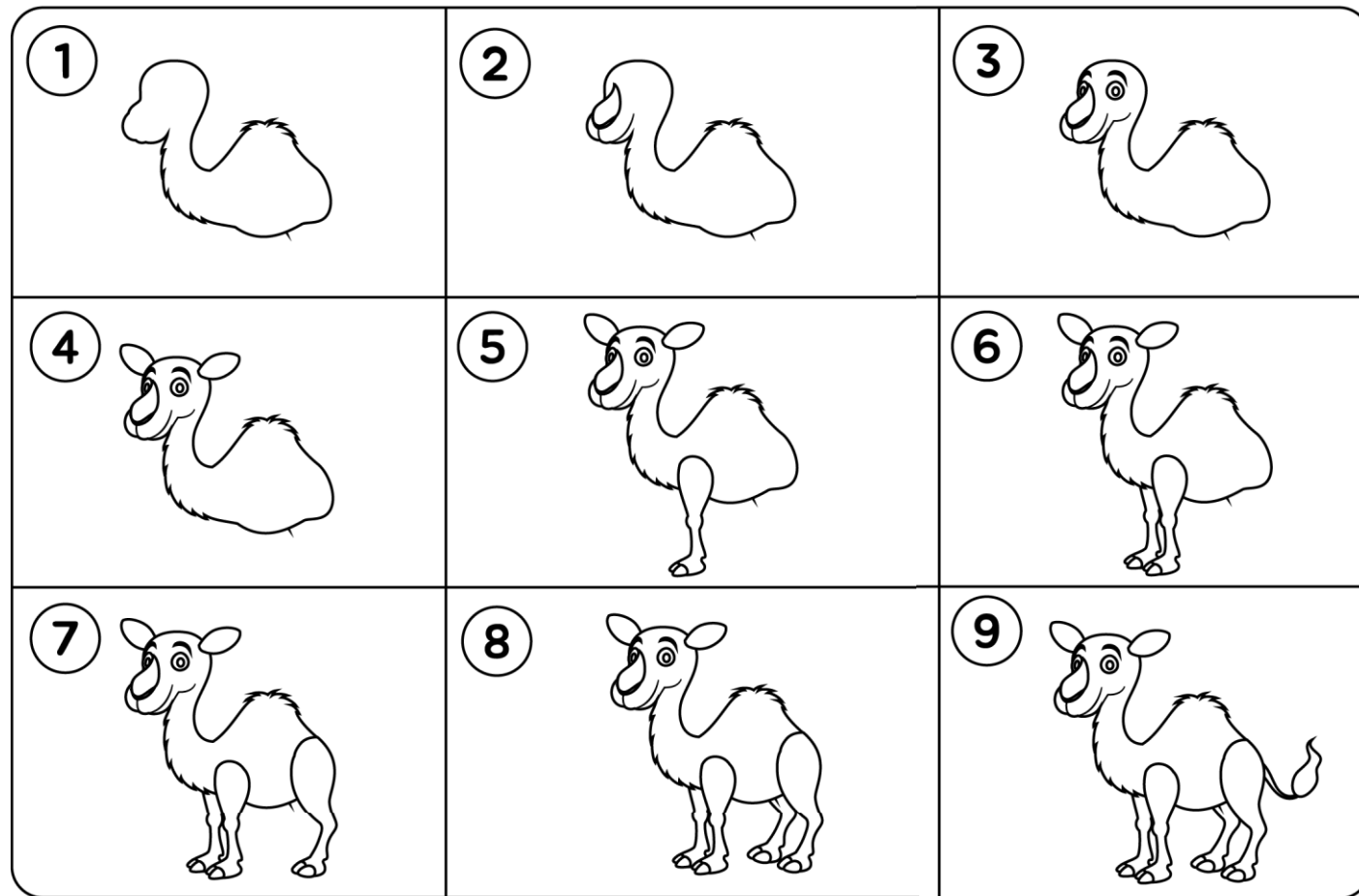

## Practice

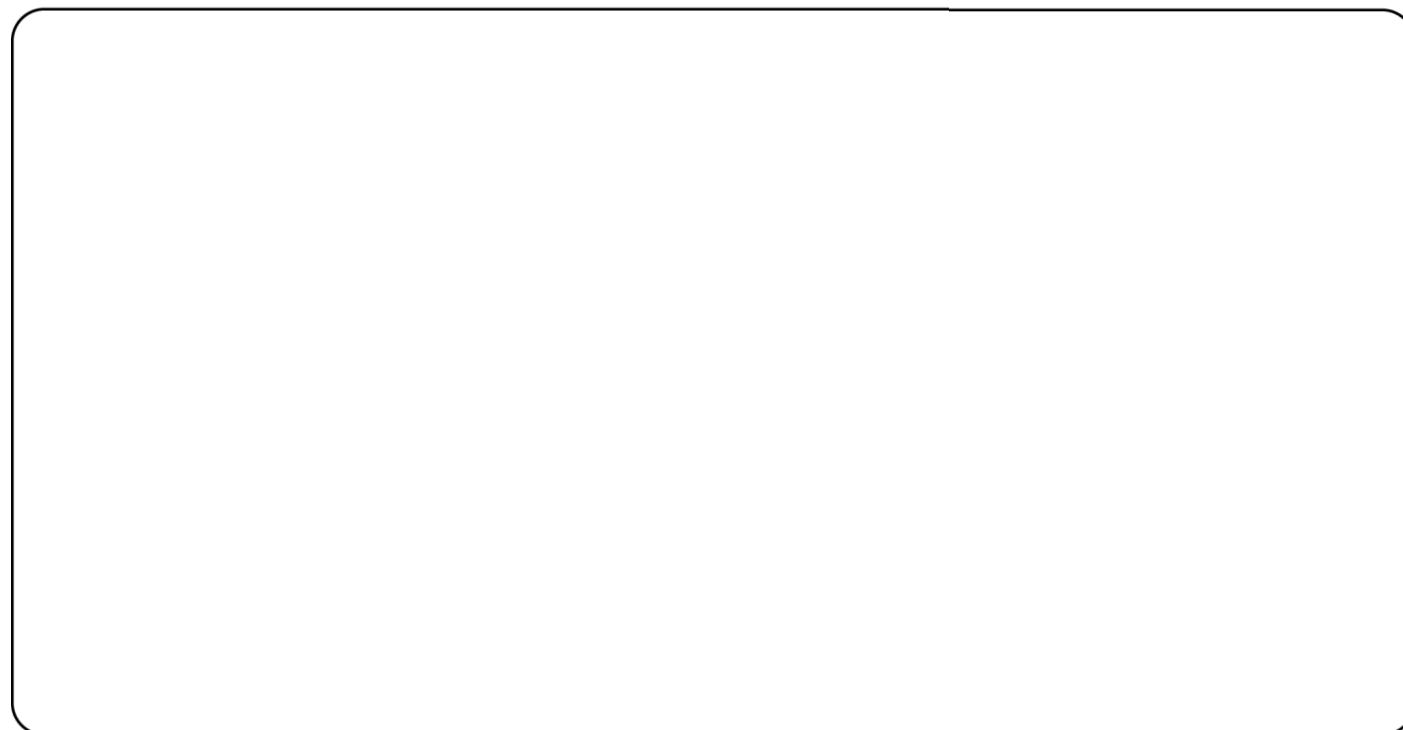

# Bench

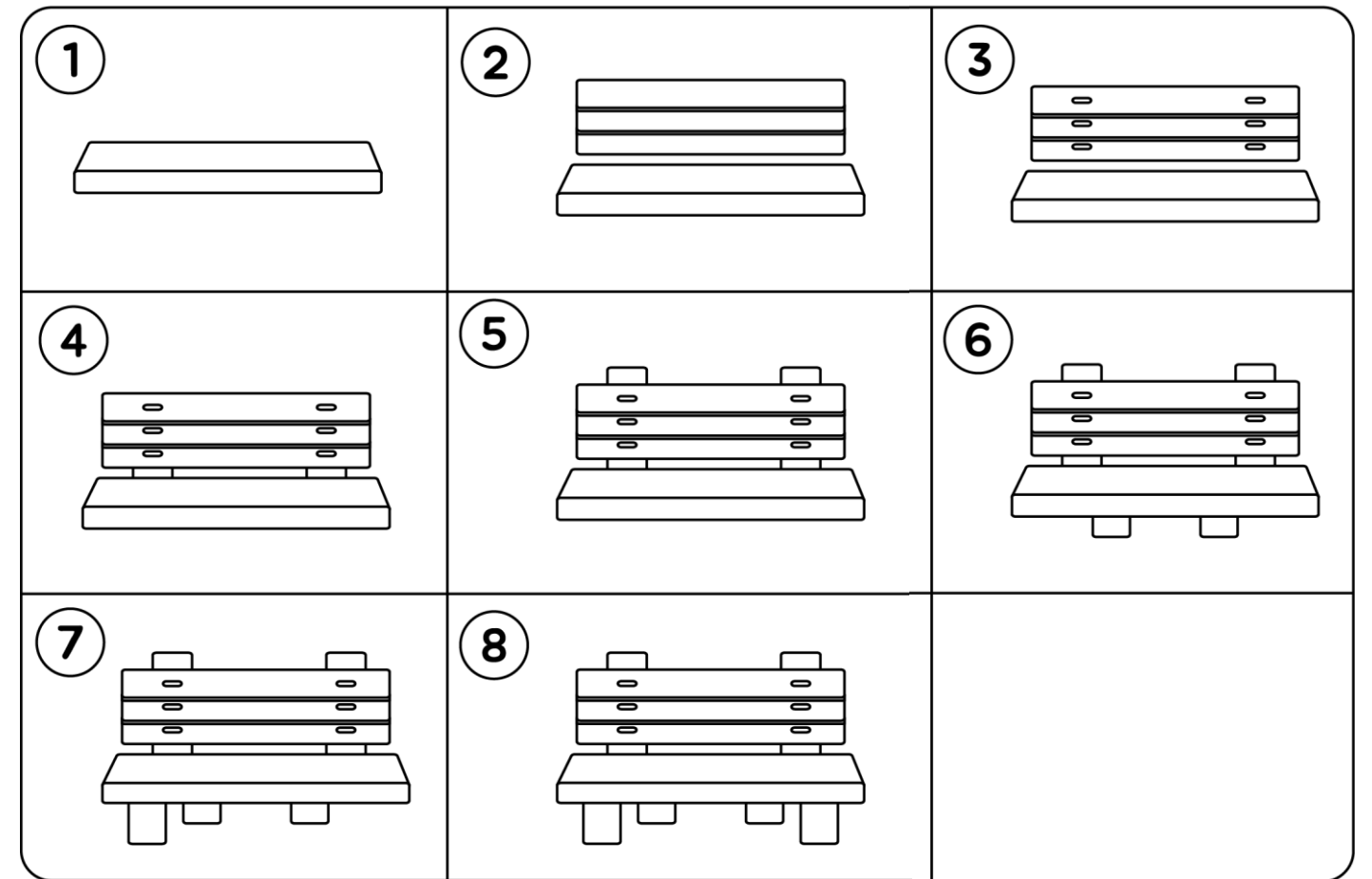

## Practice

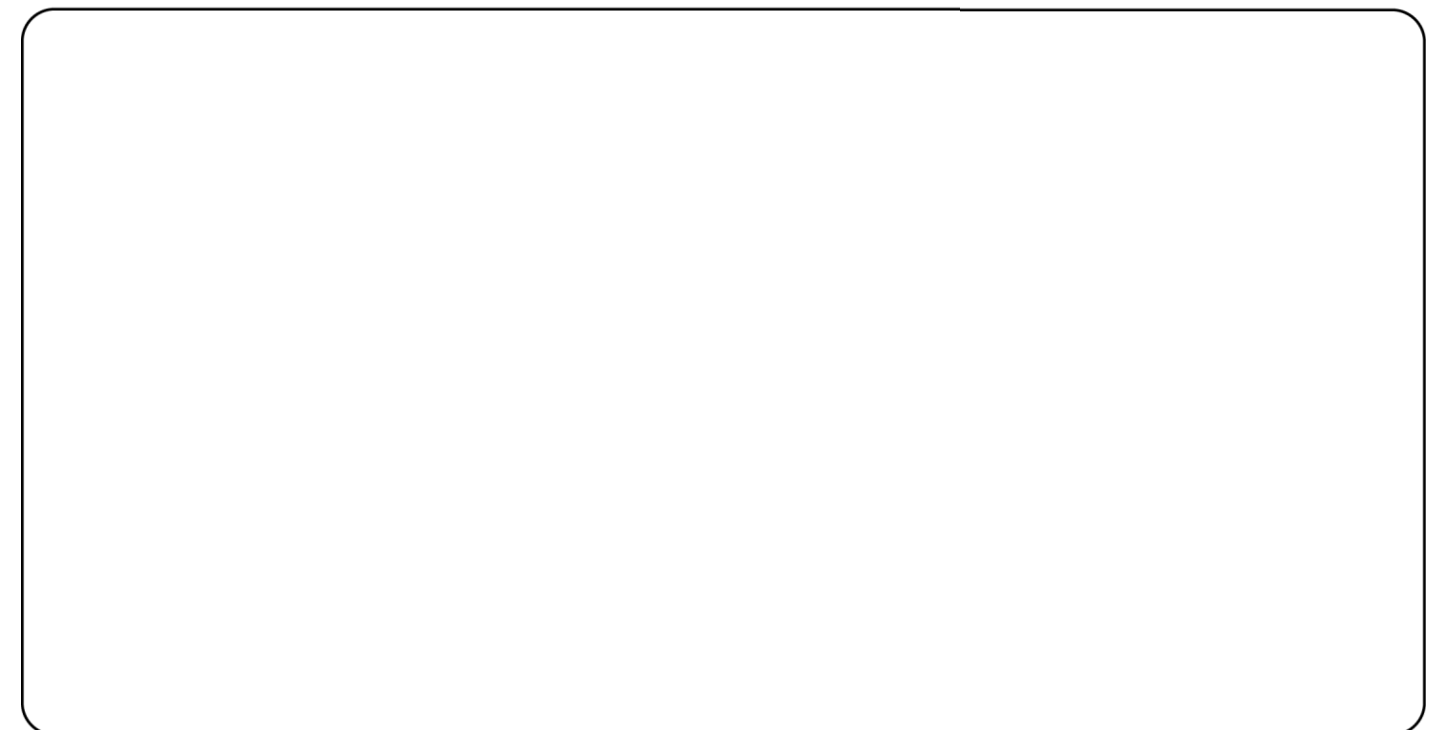

# Elephant

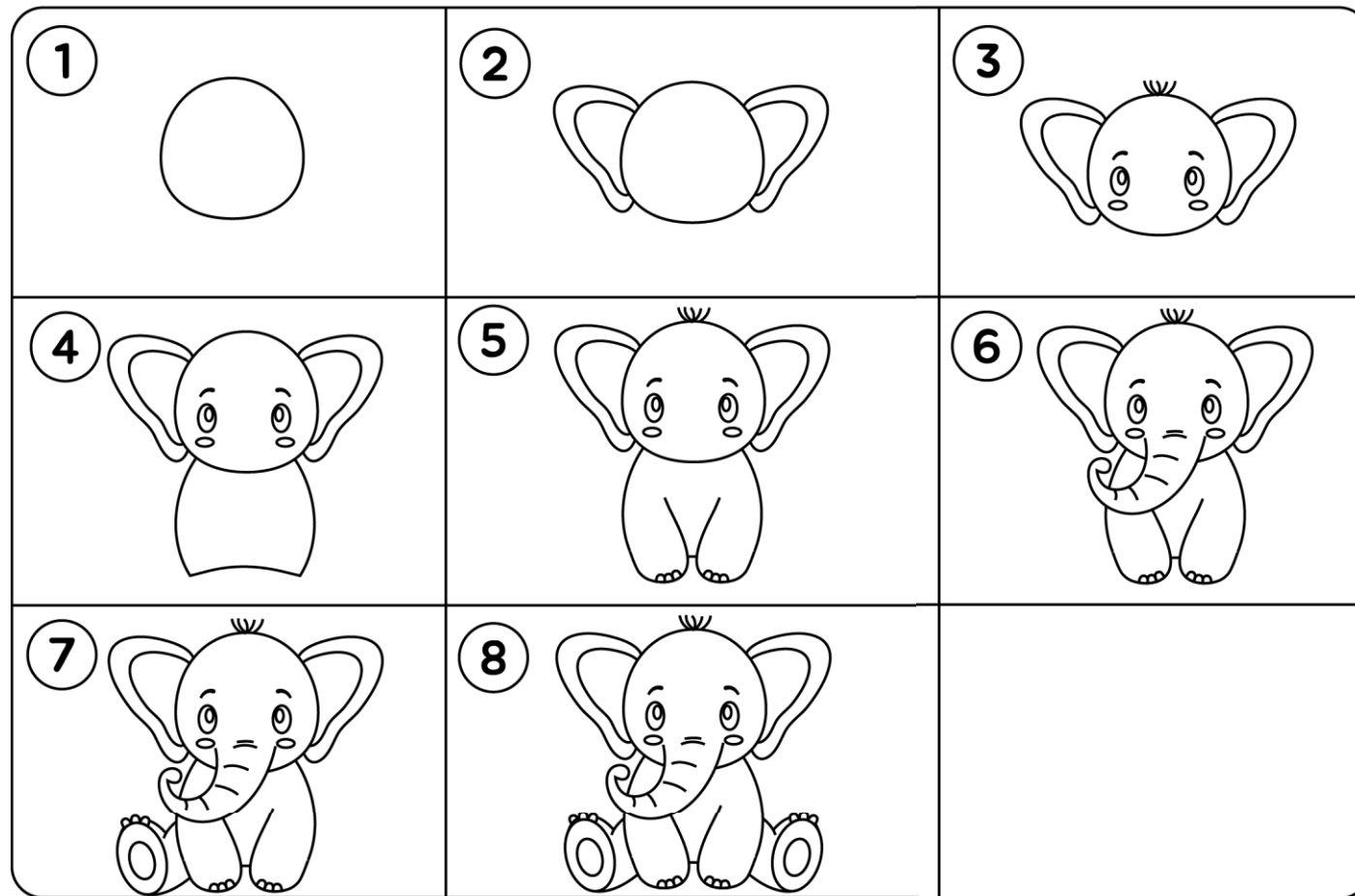

## Practice

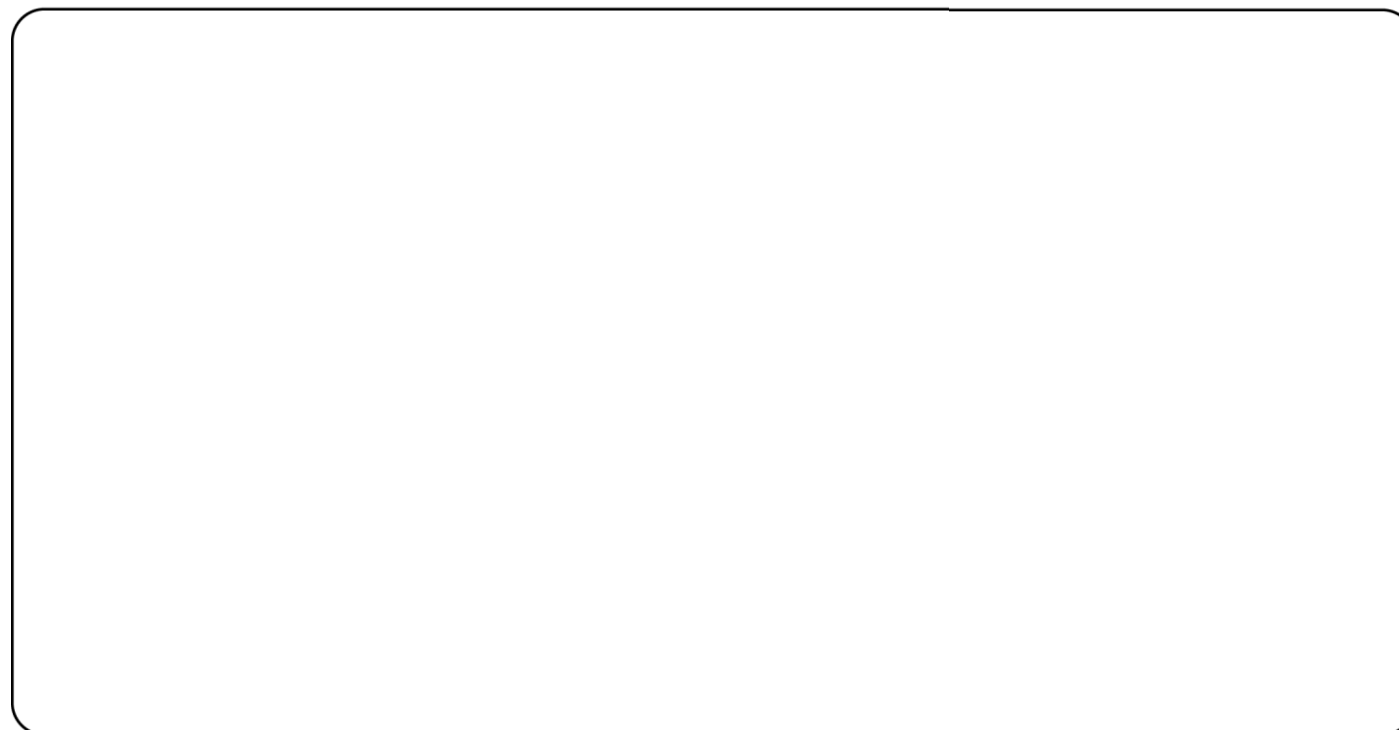

# Castle

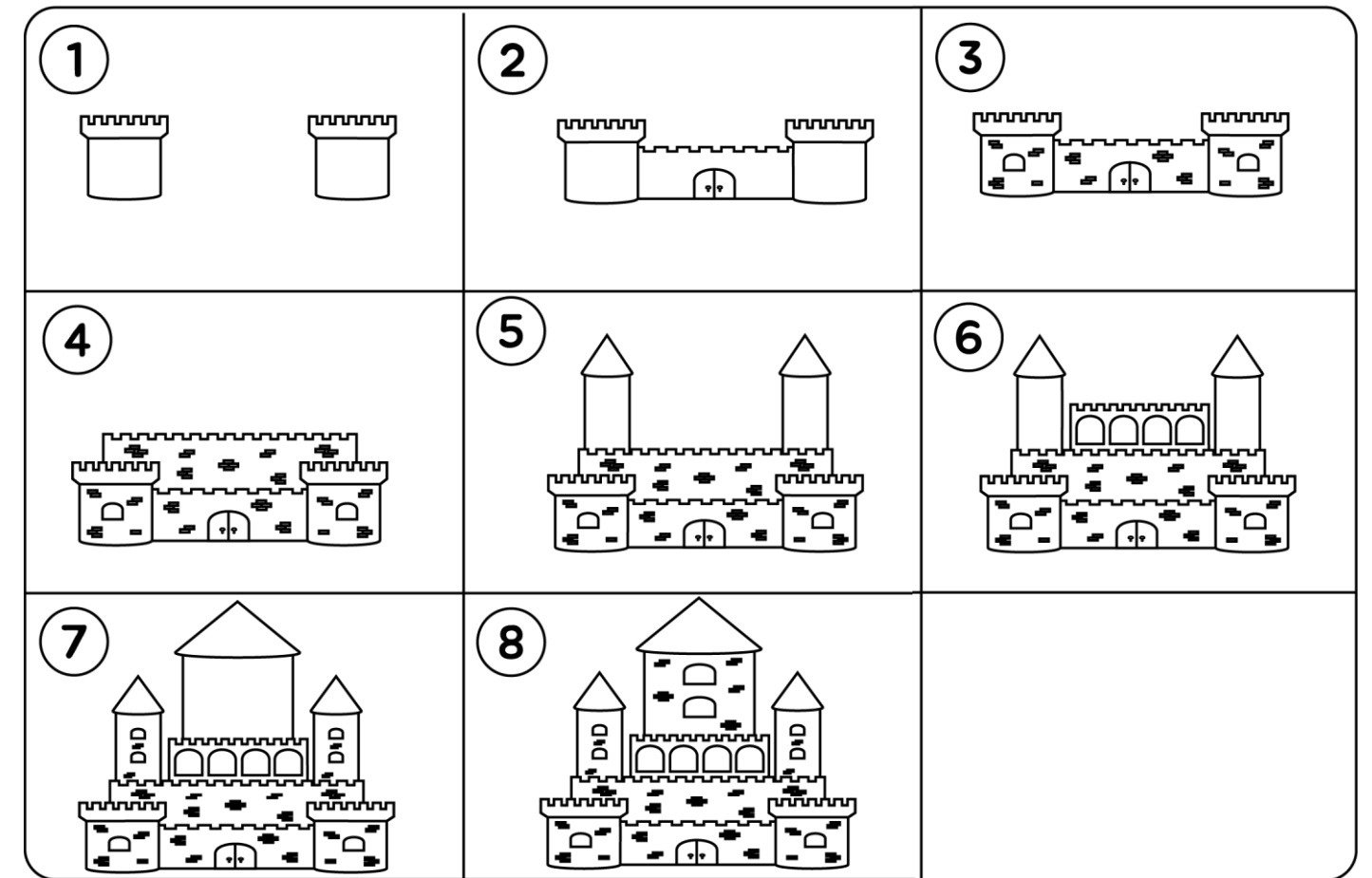

## Practice

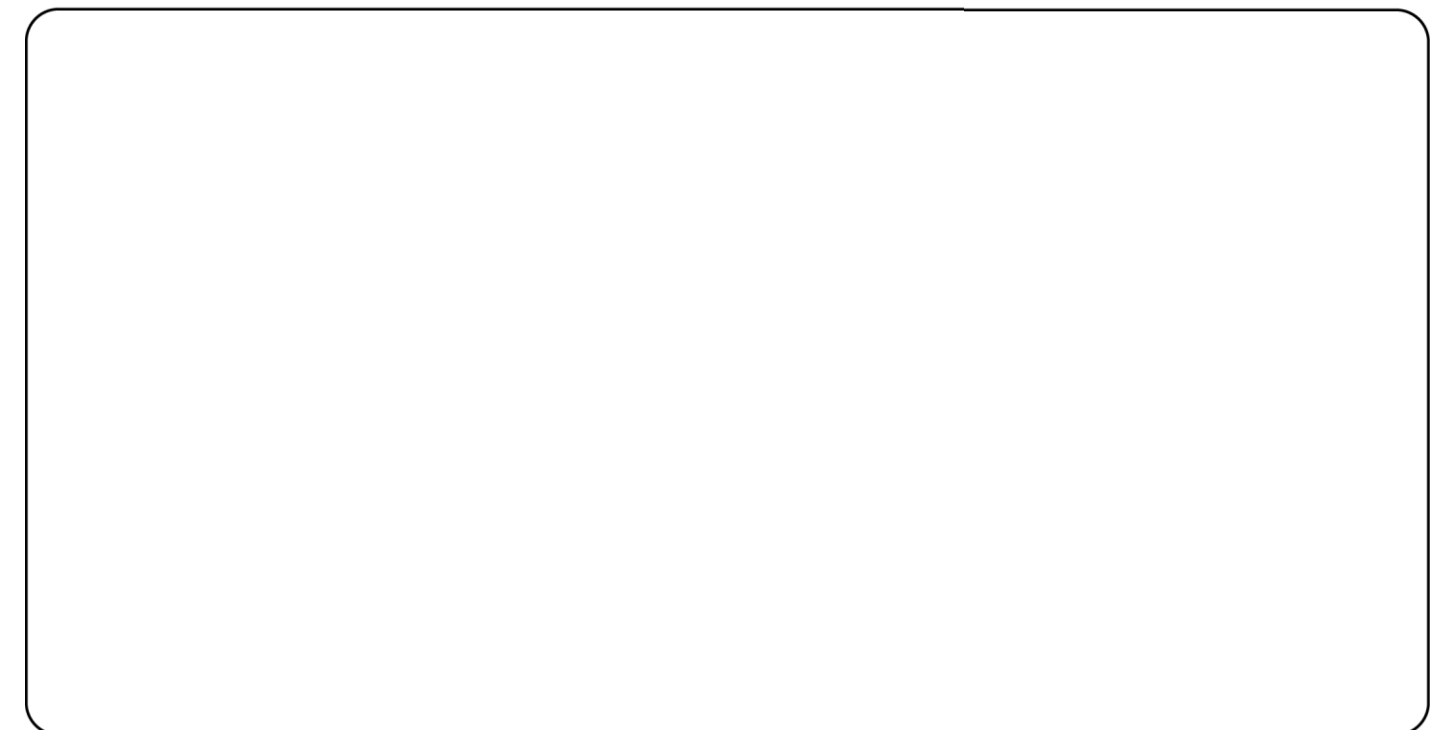

# Witch Hat

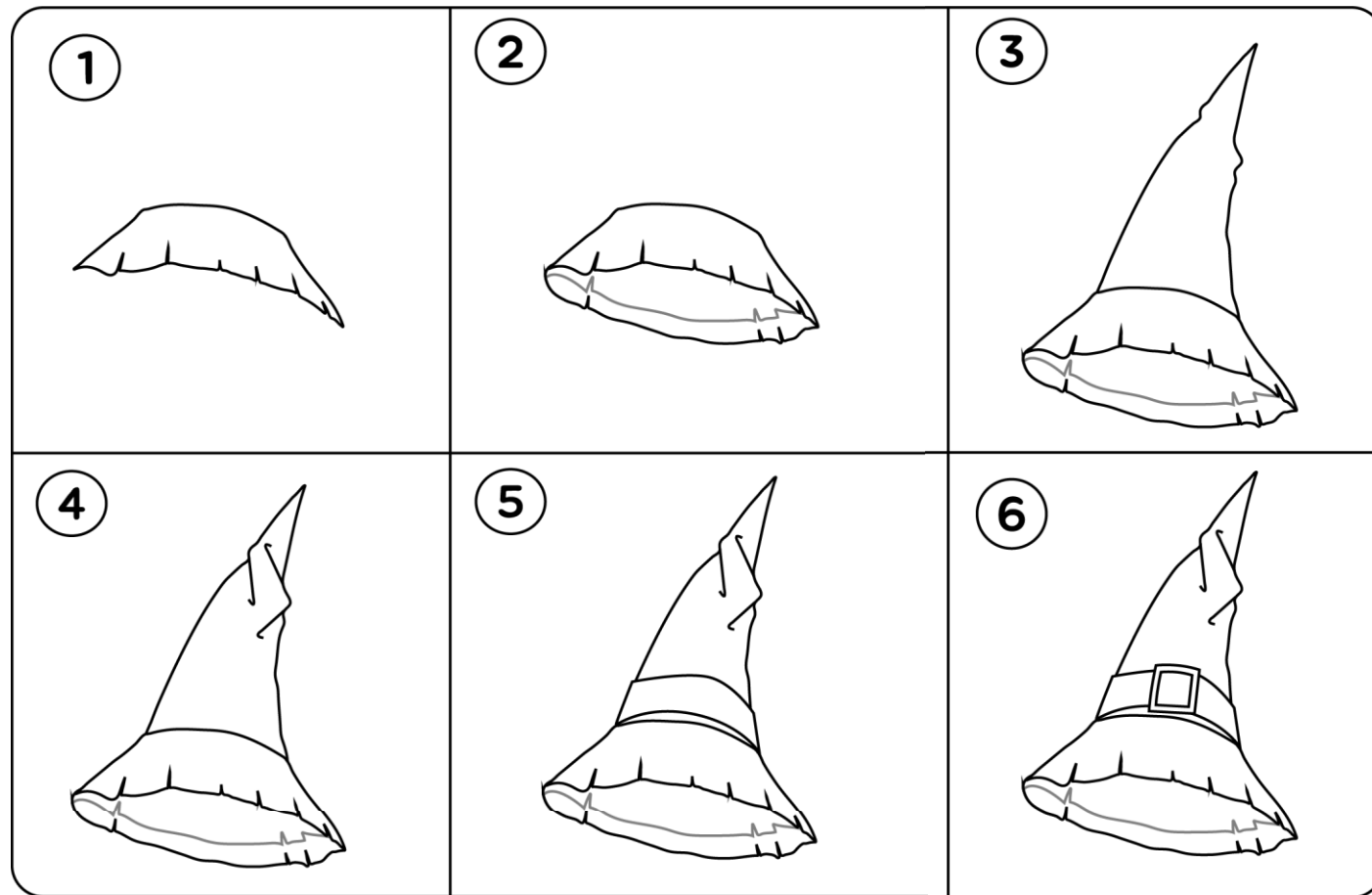

## Practice

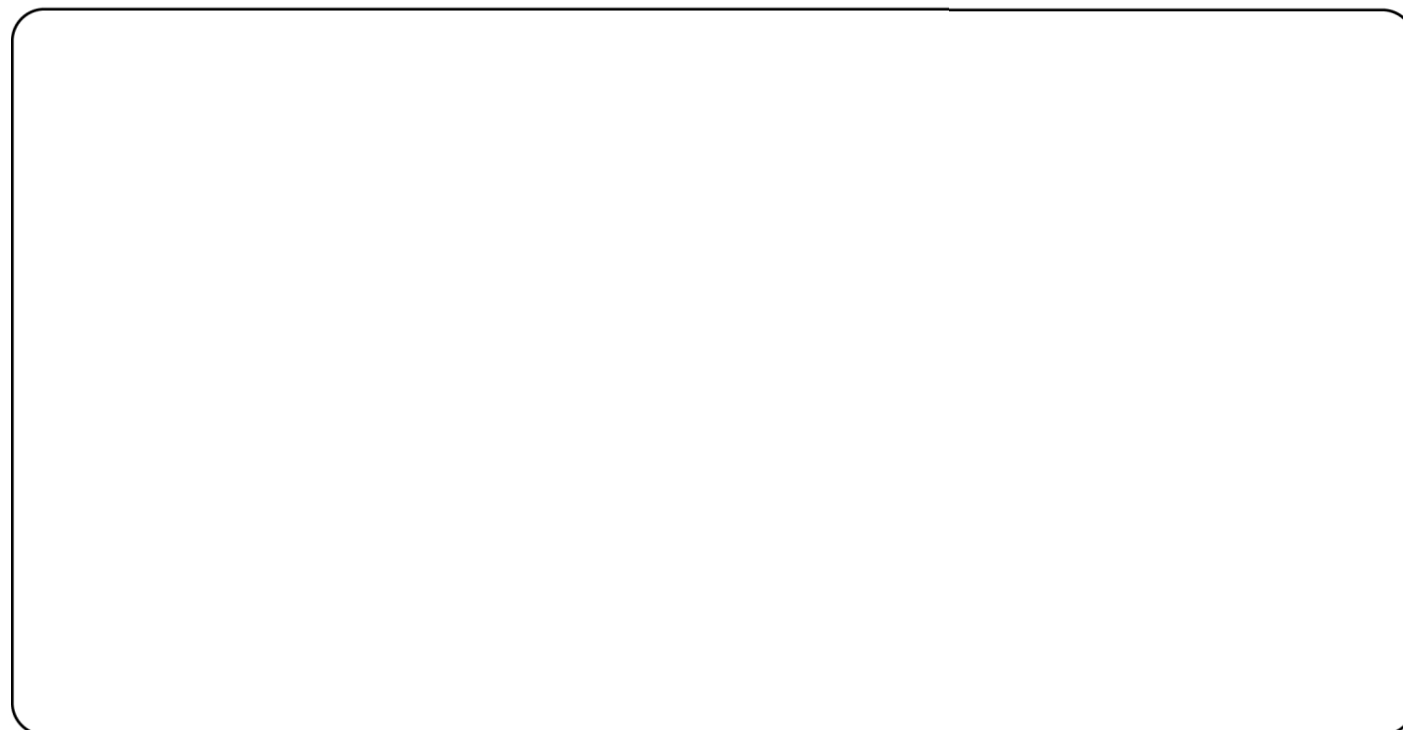

# Seal

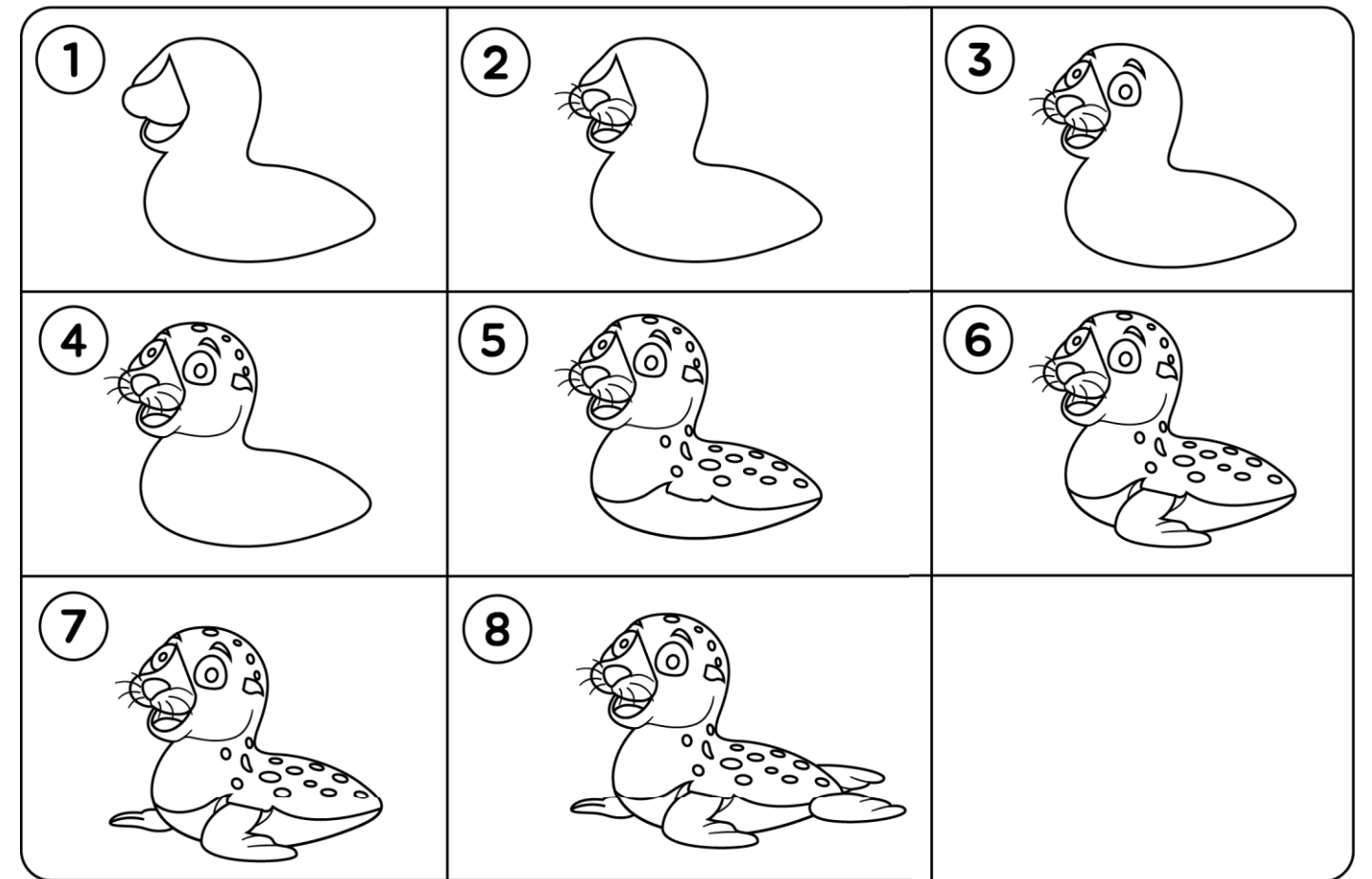

## Practice

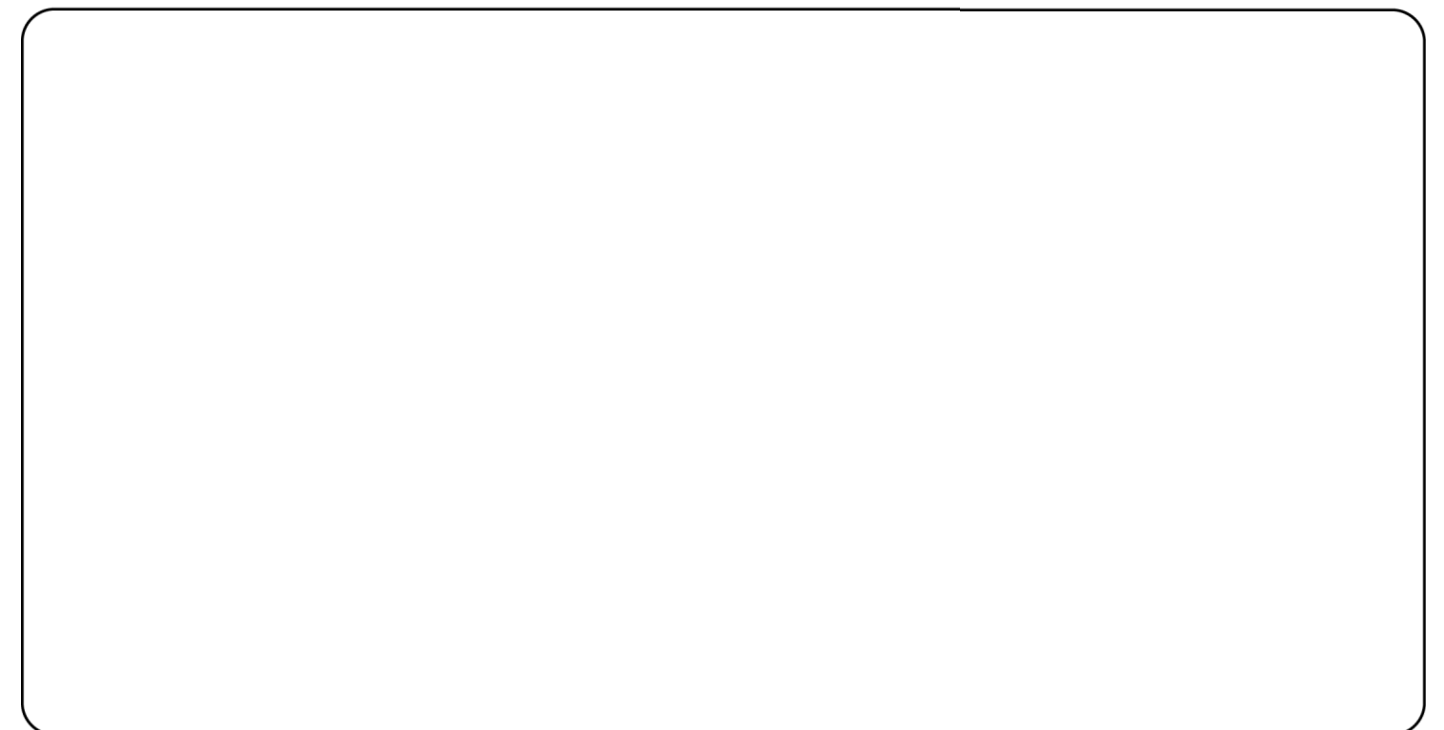

# Cobra

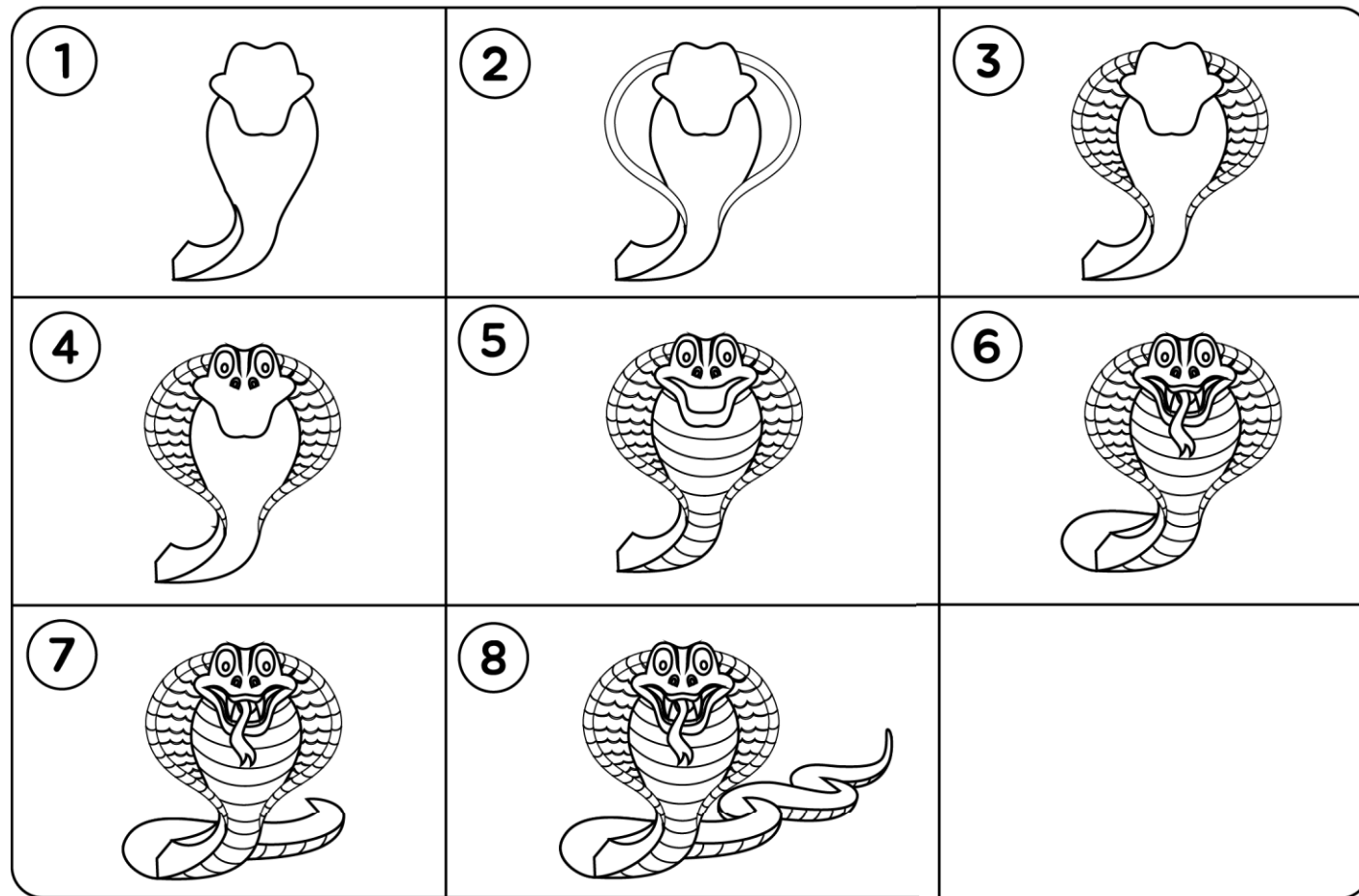

## Practice

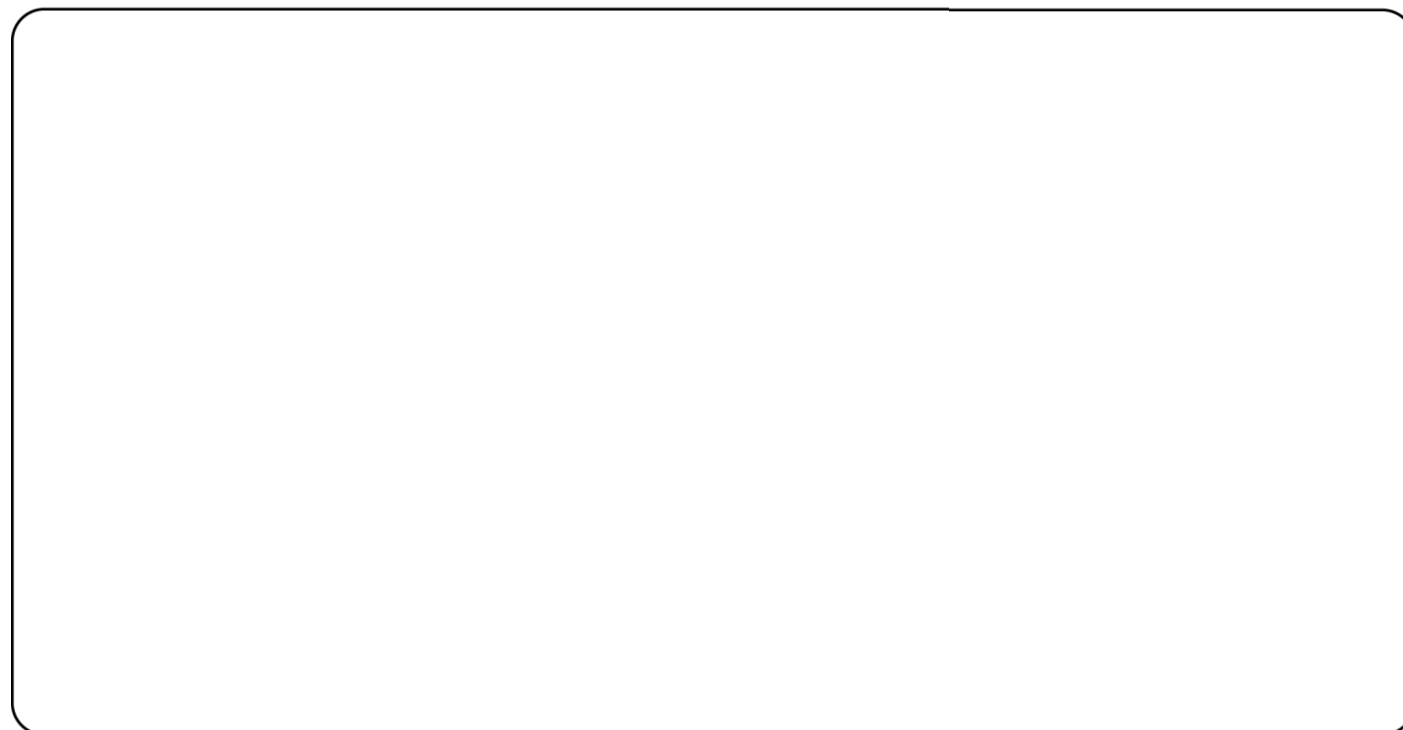

# Turtle

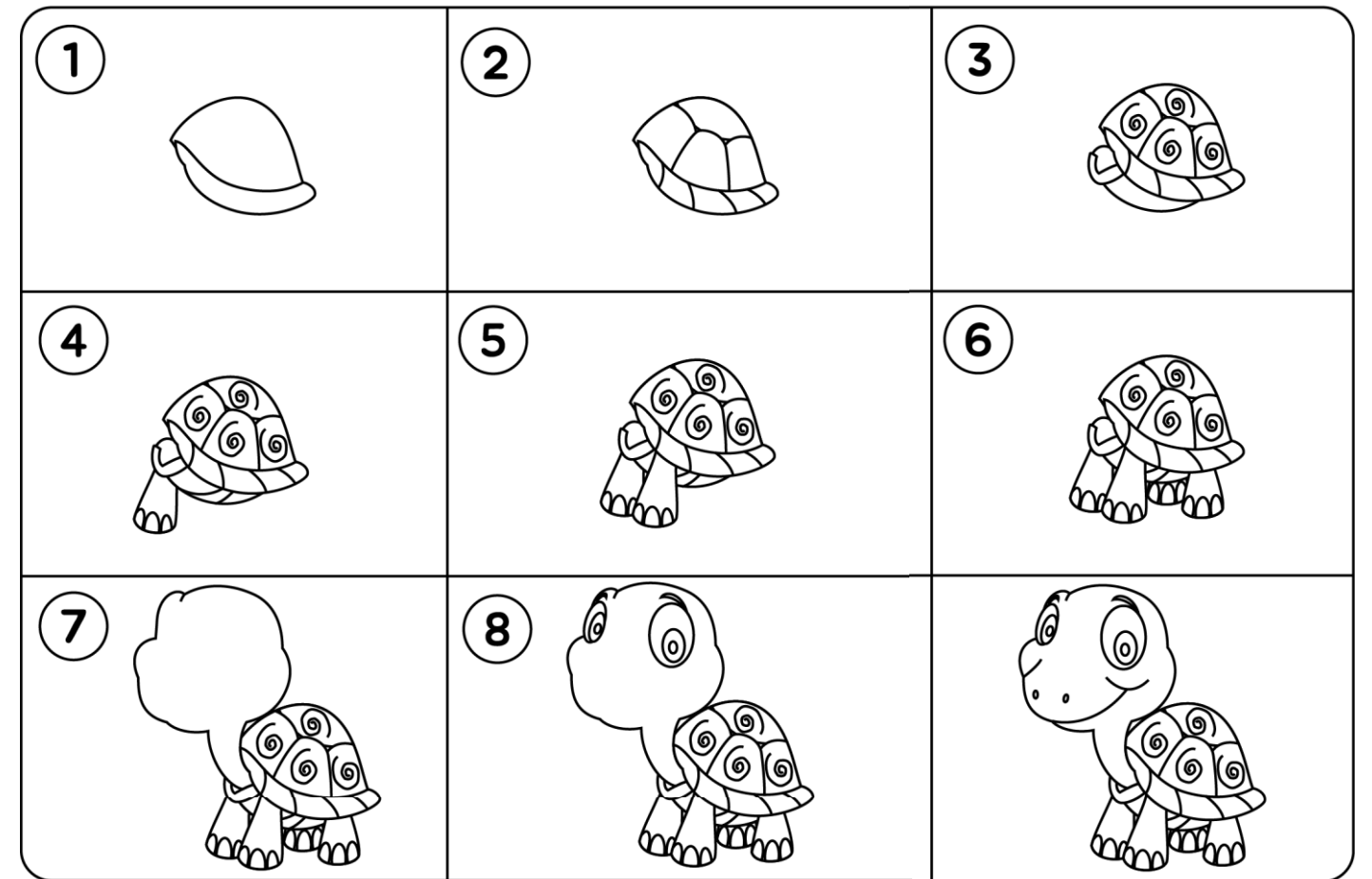

## Practice

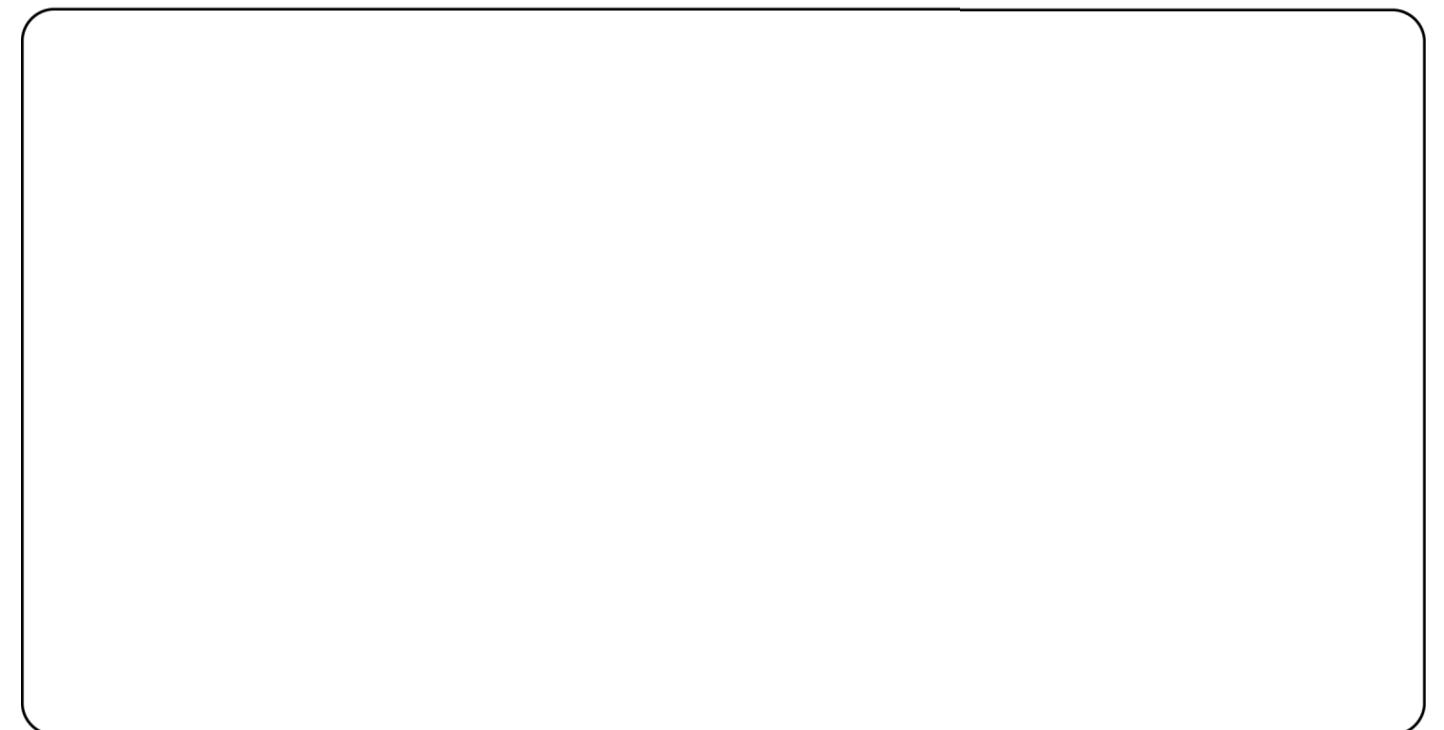

# Caterpillar

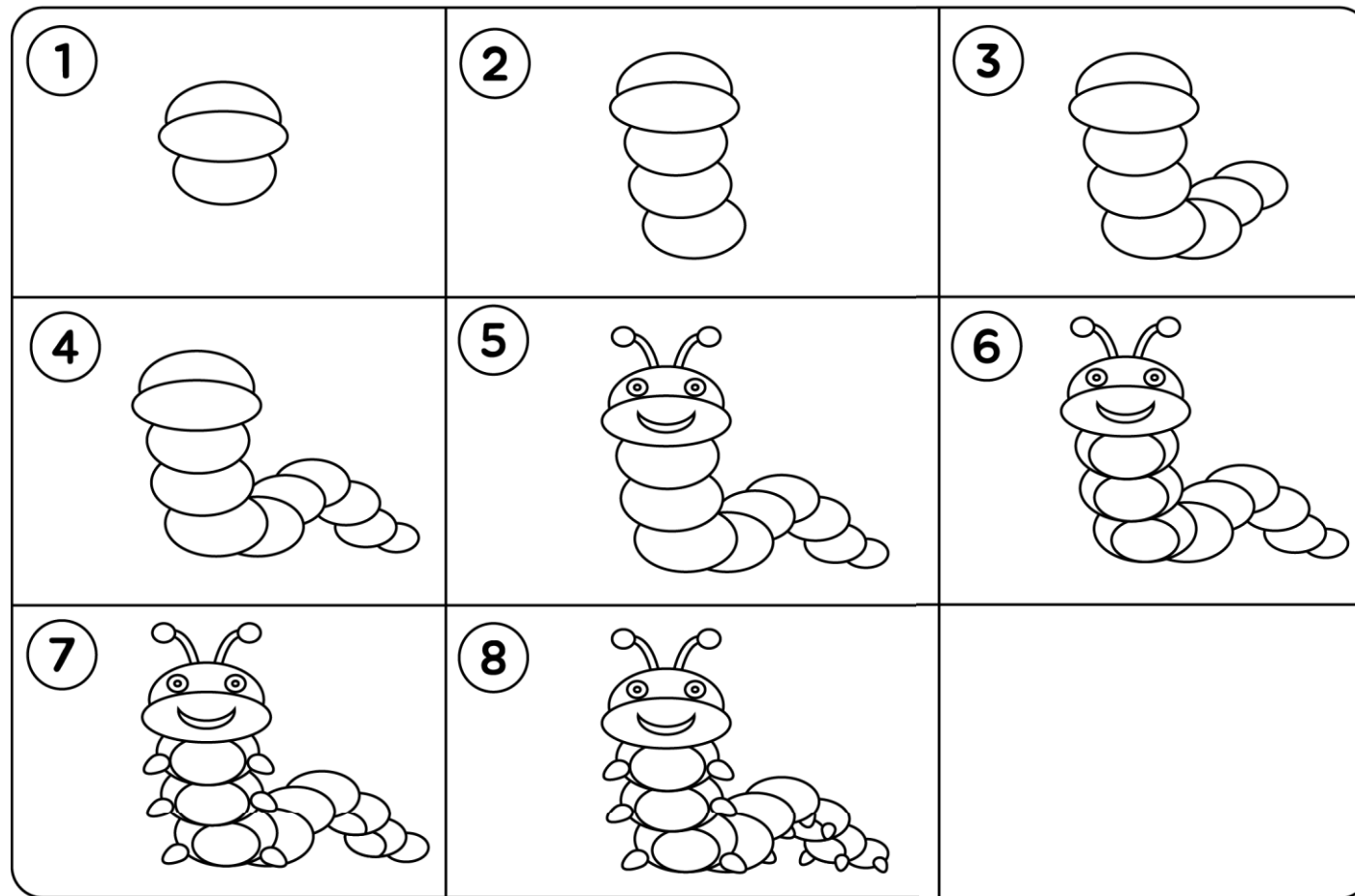

## Practice

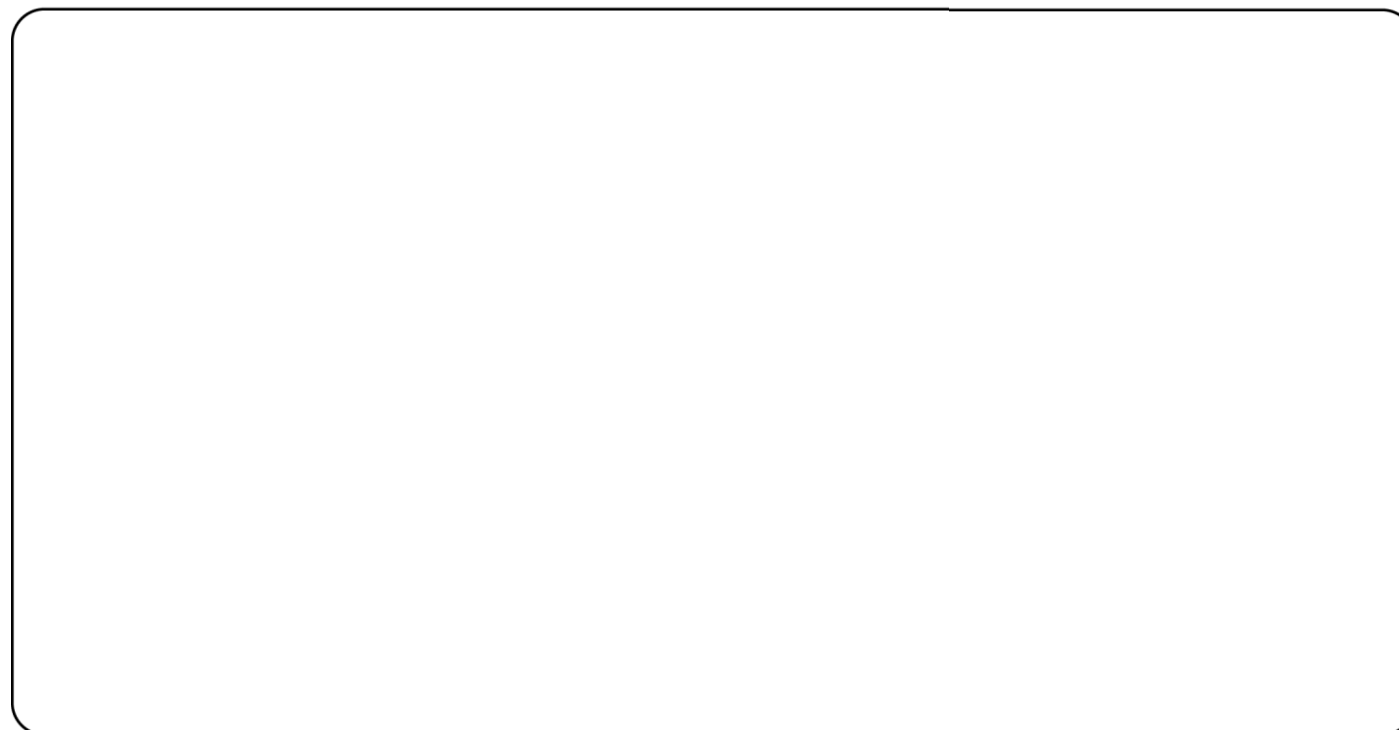

# Lynx

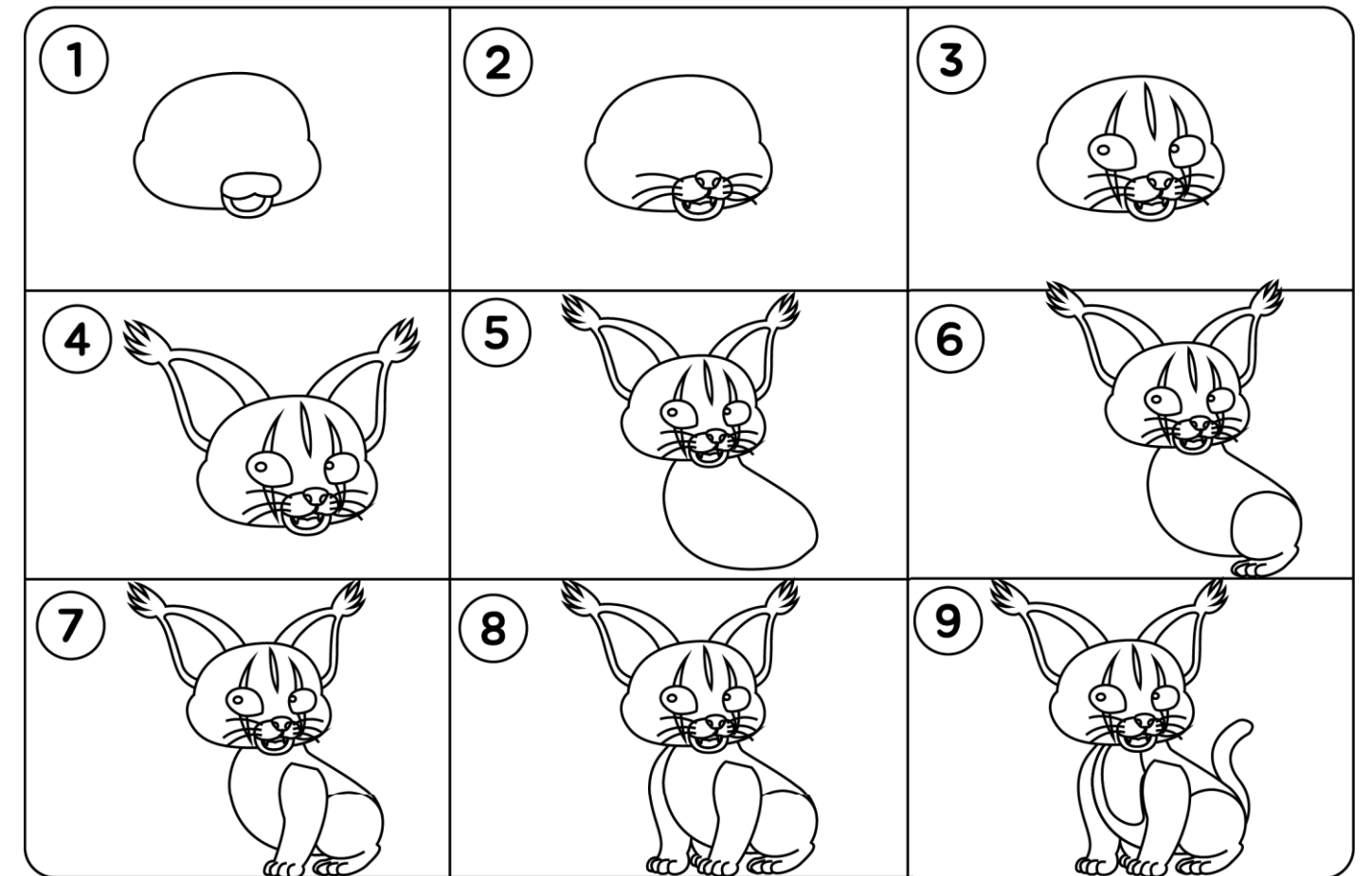

## Practice

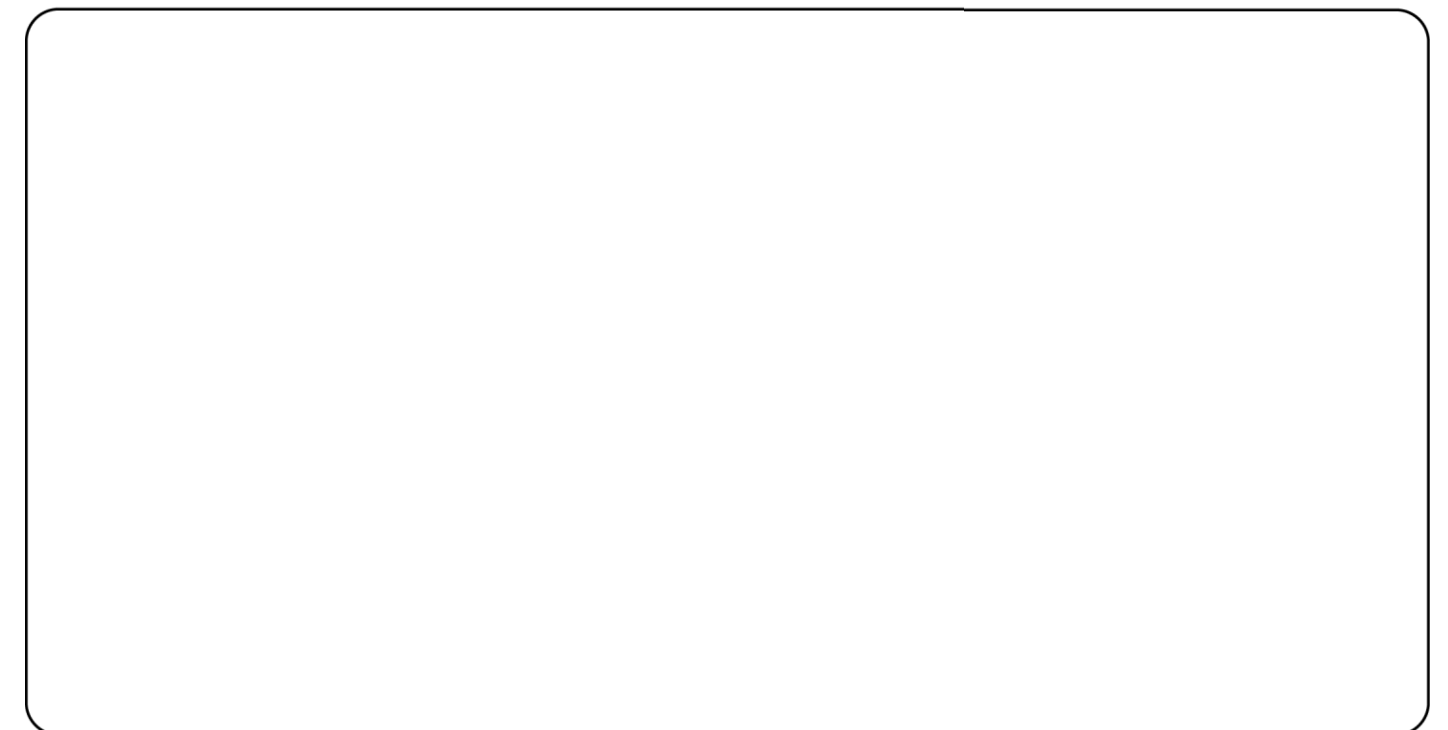

# Sheep

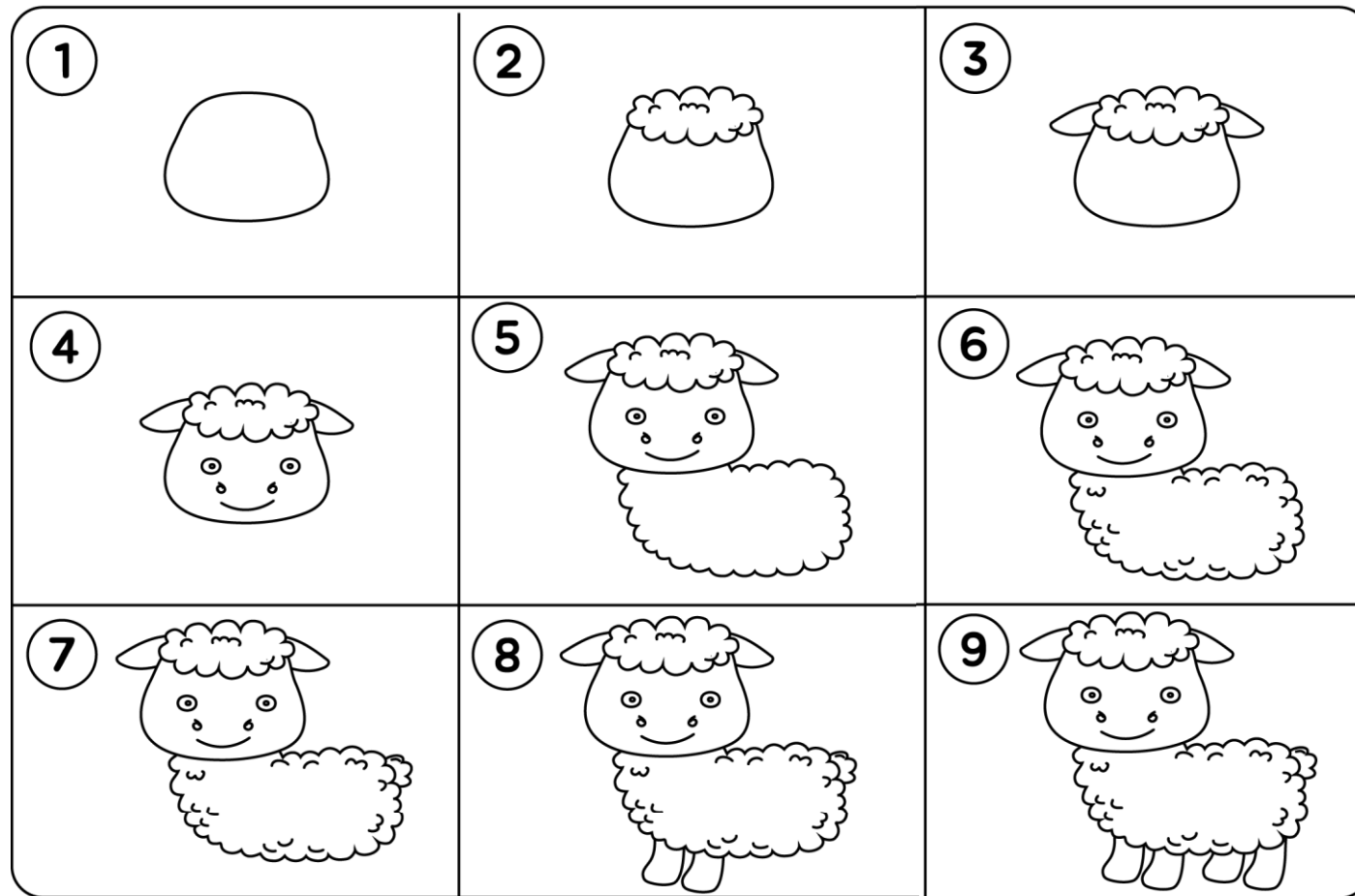

## Practice

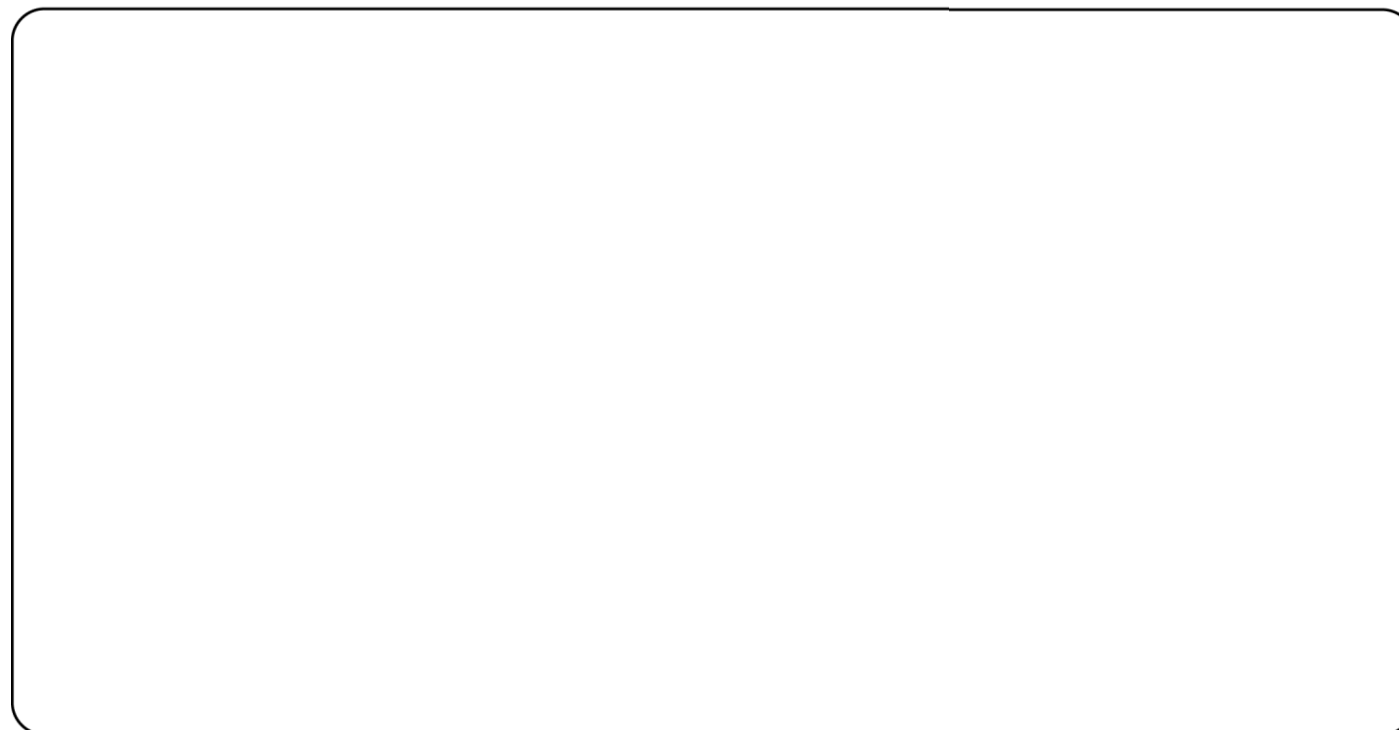

# Tooth Fairy

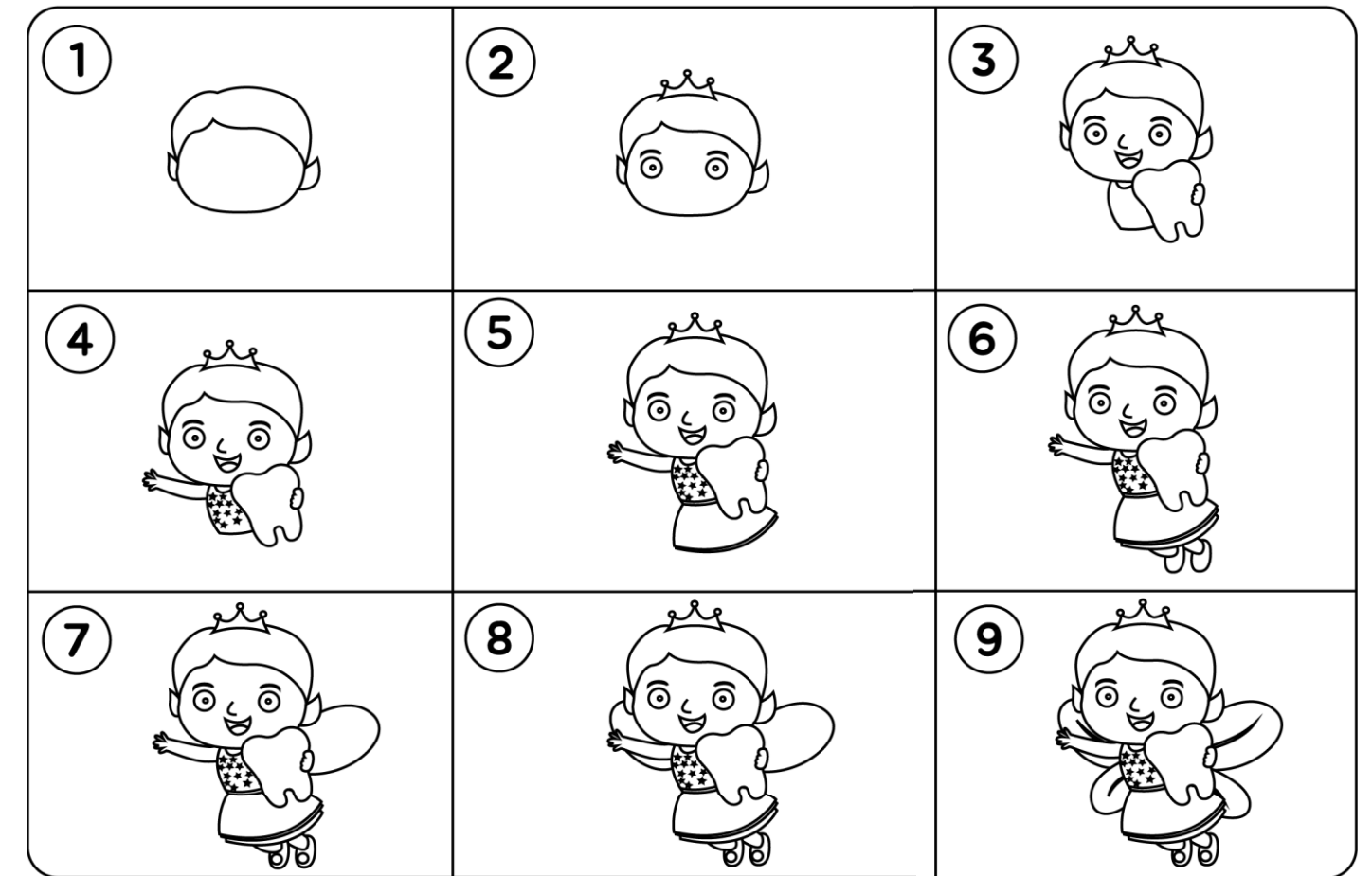

## Practice

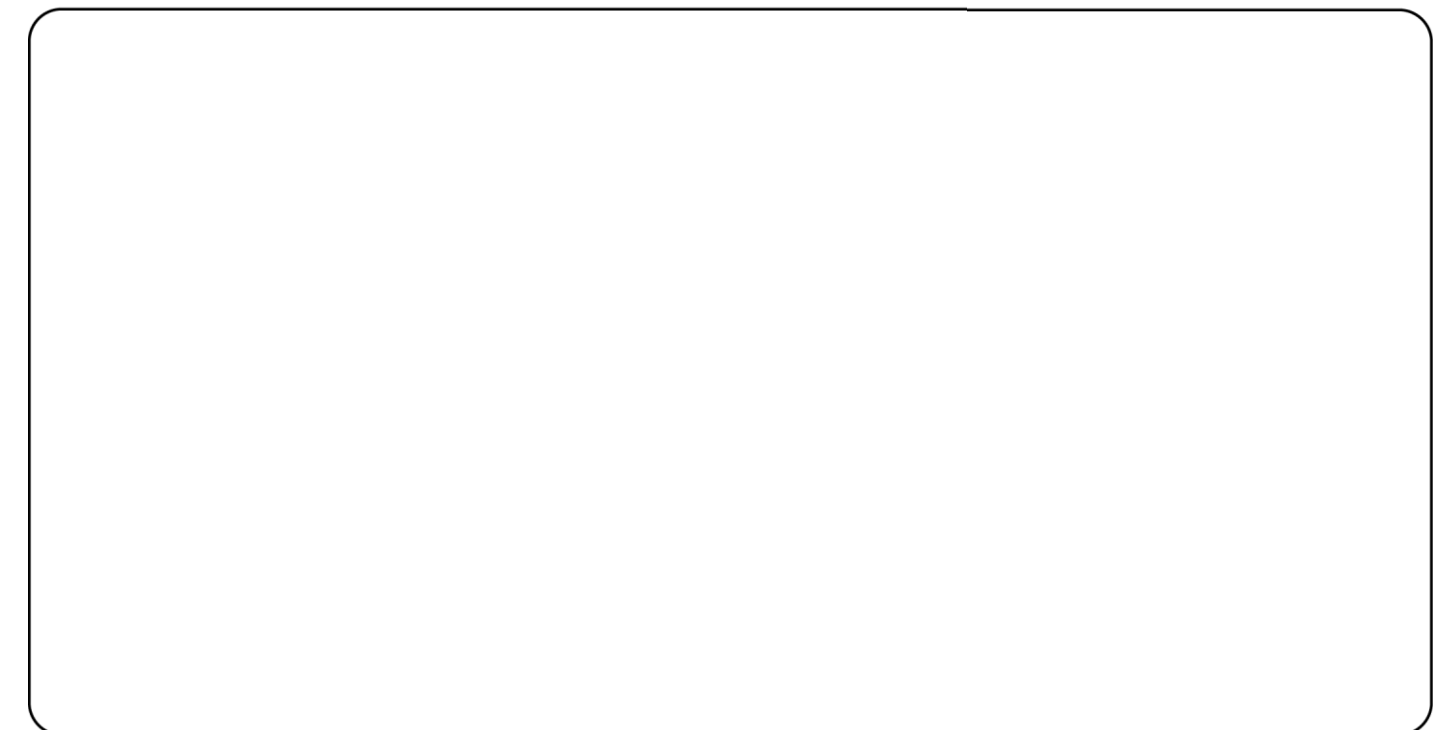

# Deer

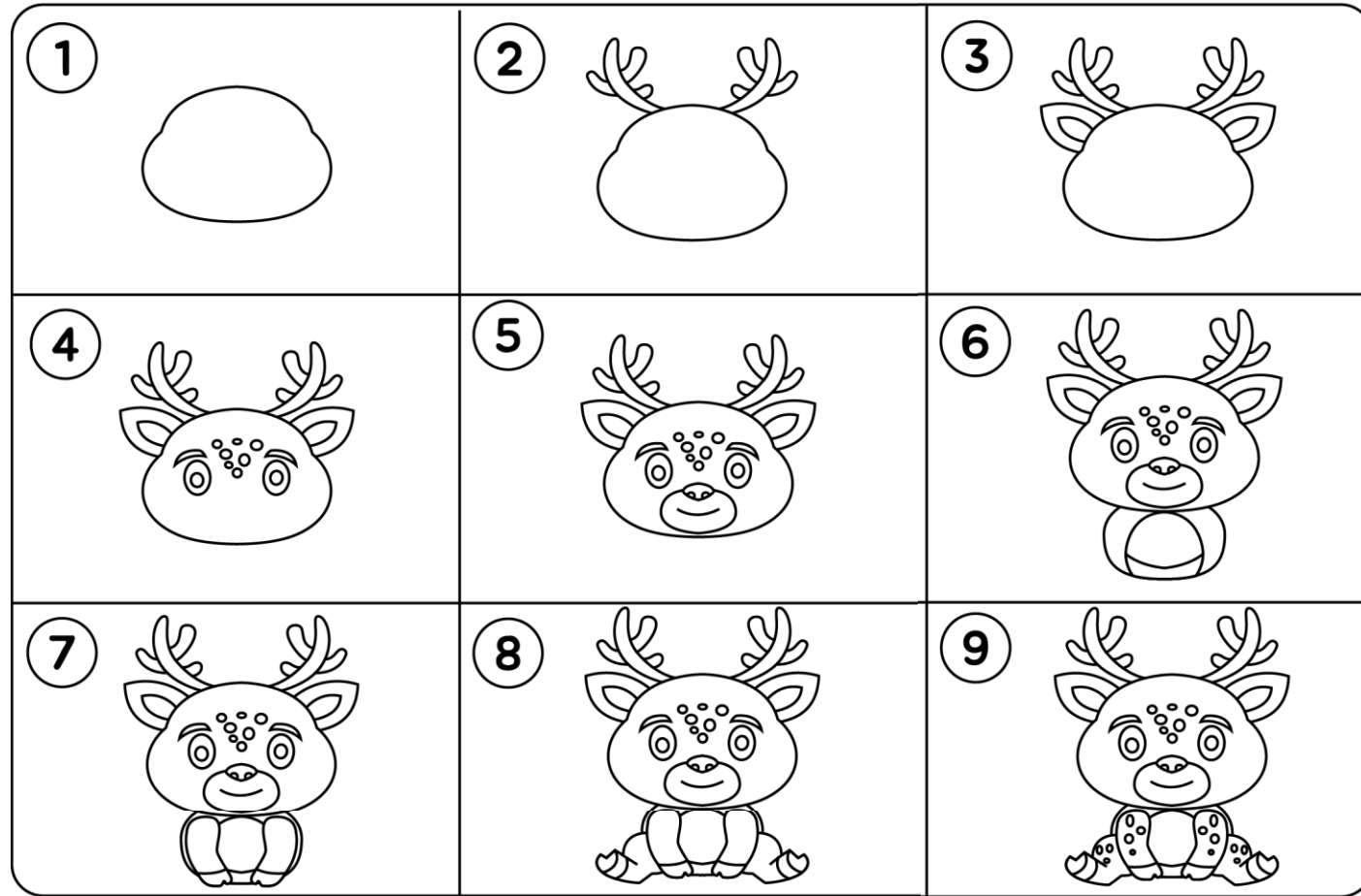

# Practice

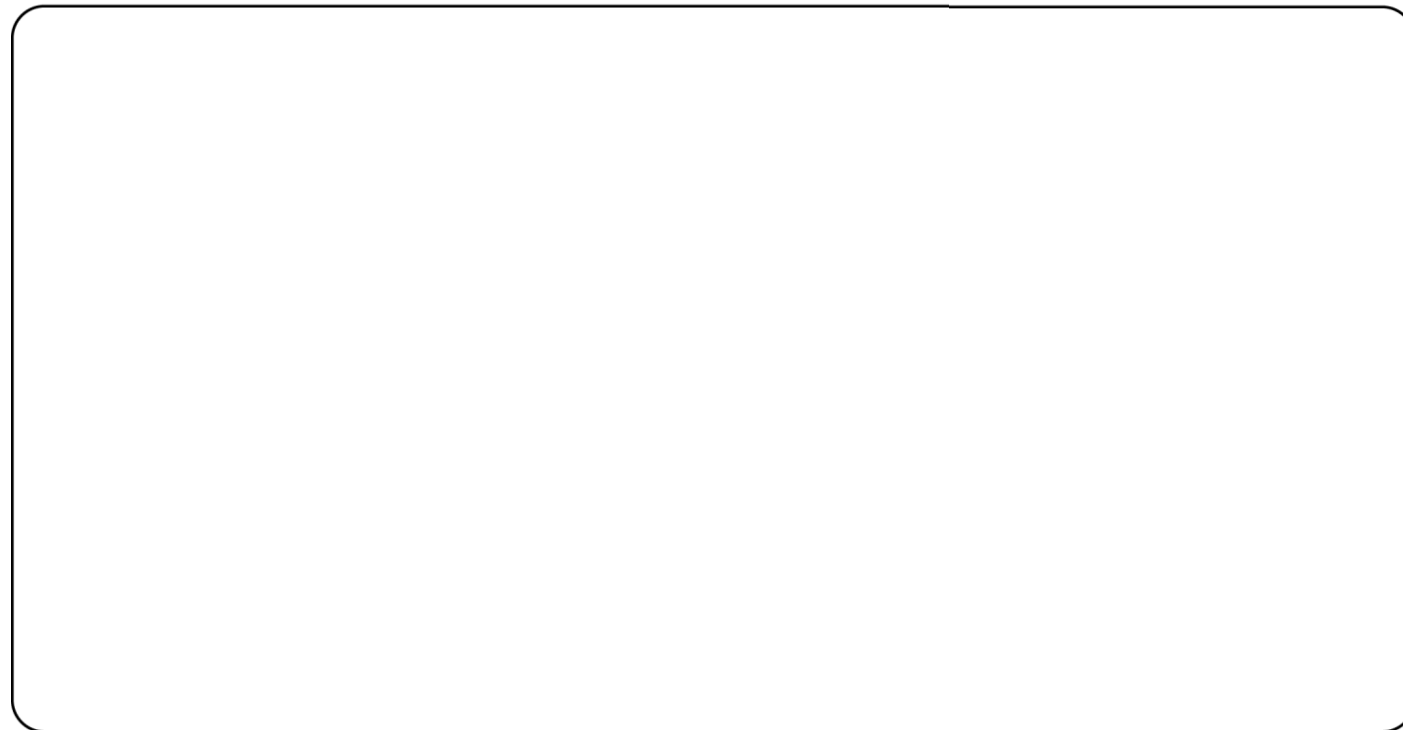

# Crab

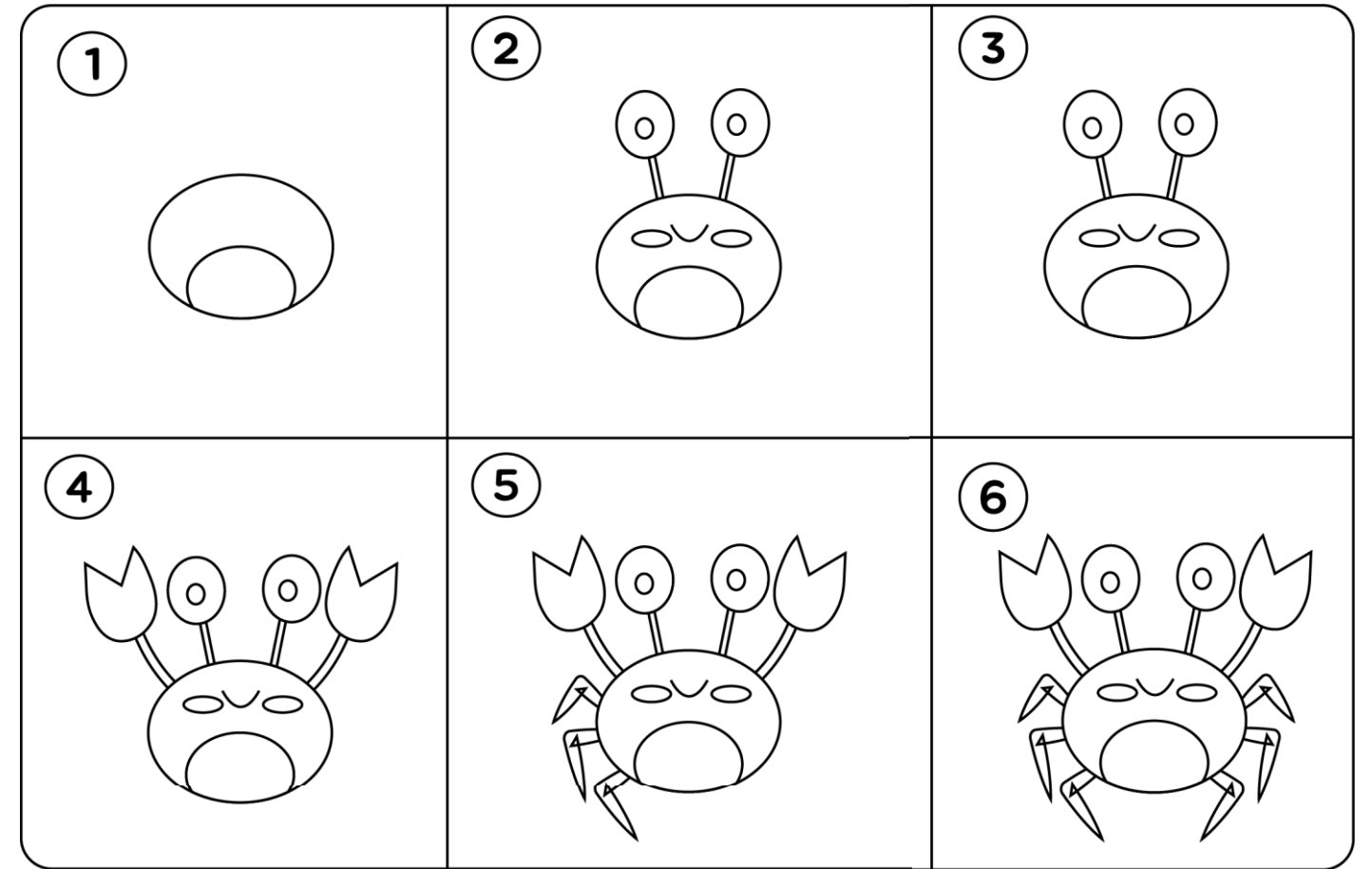

# Practice

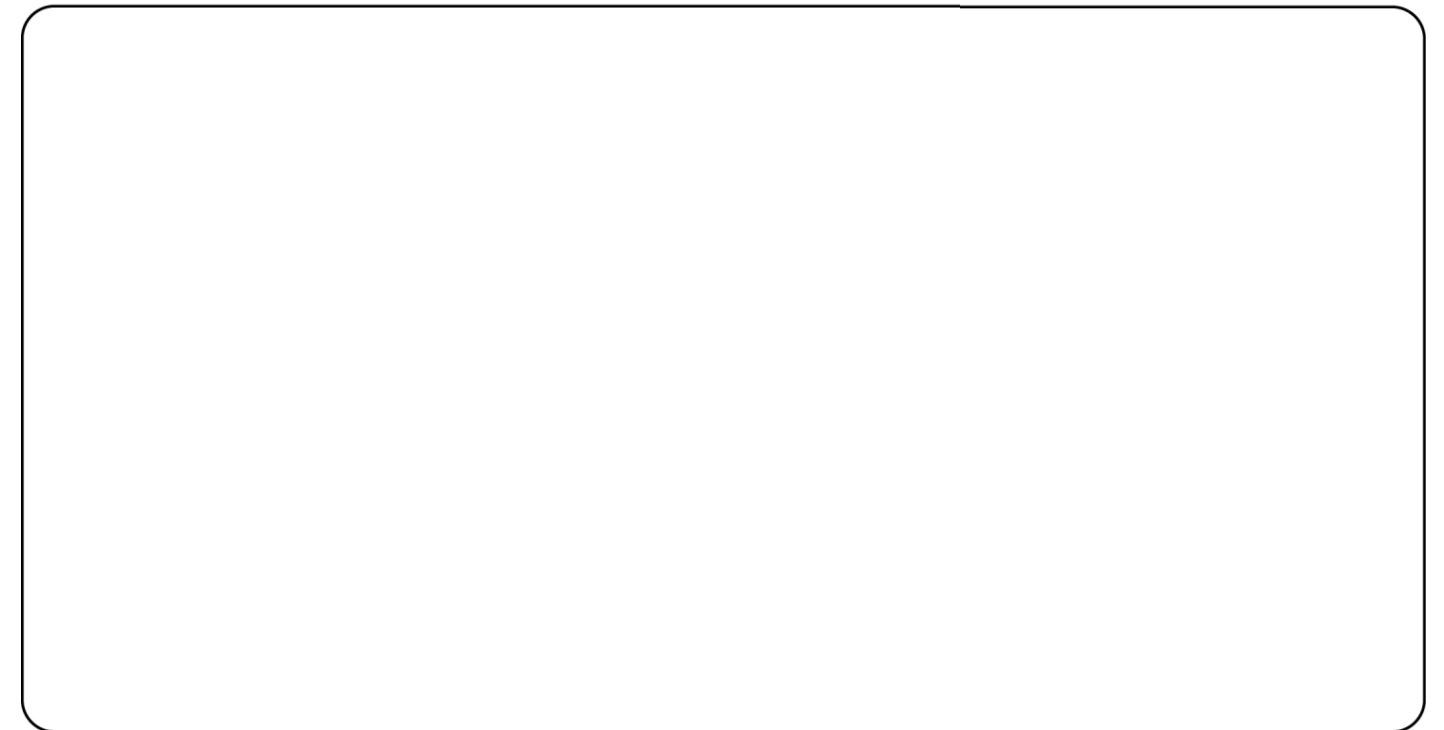

# Firefly

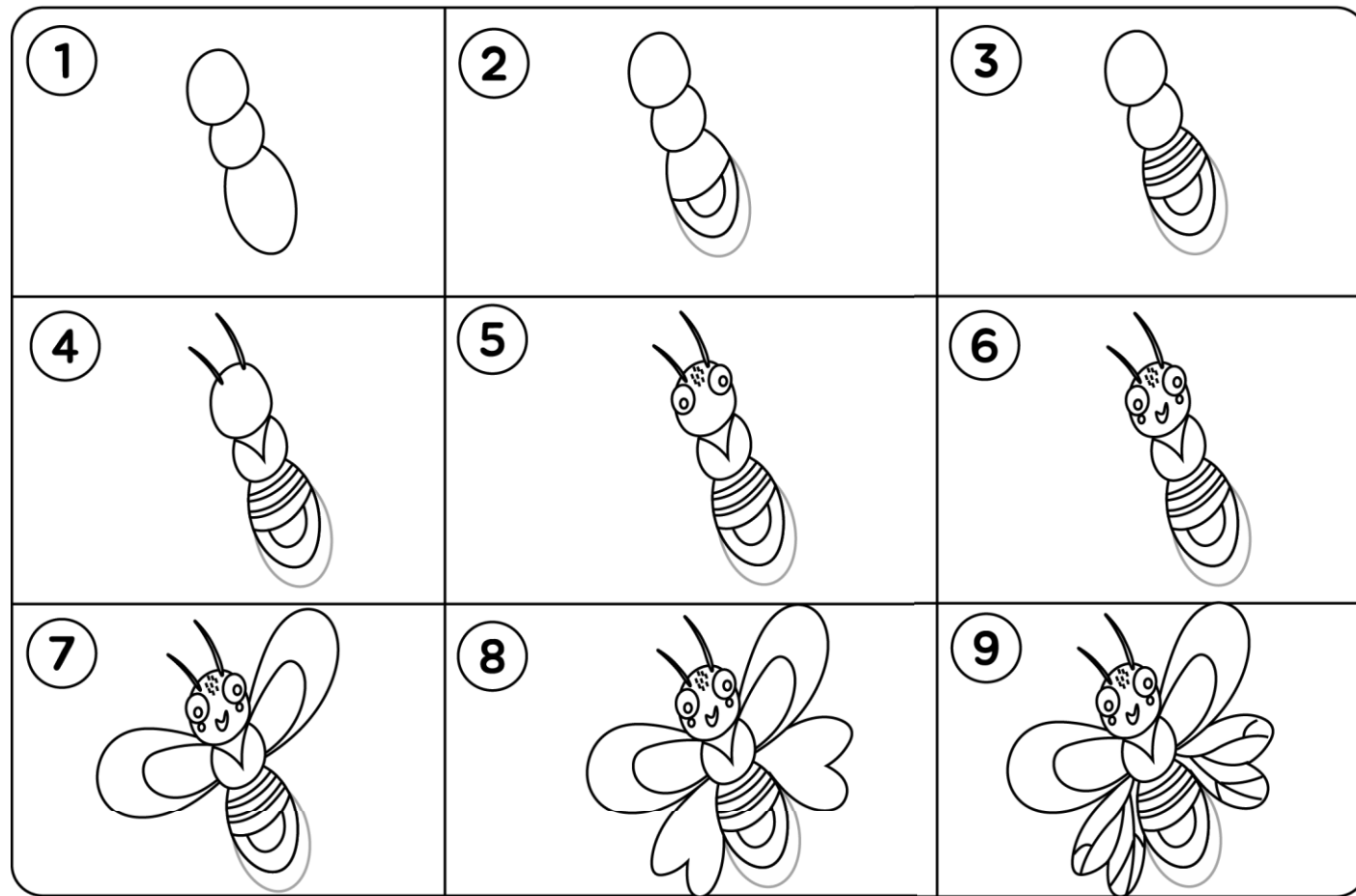

## Practice

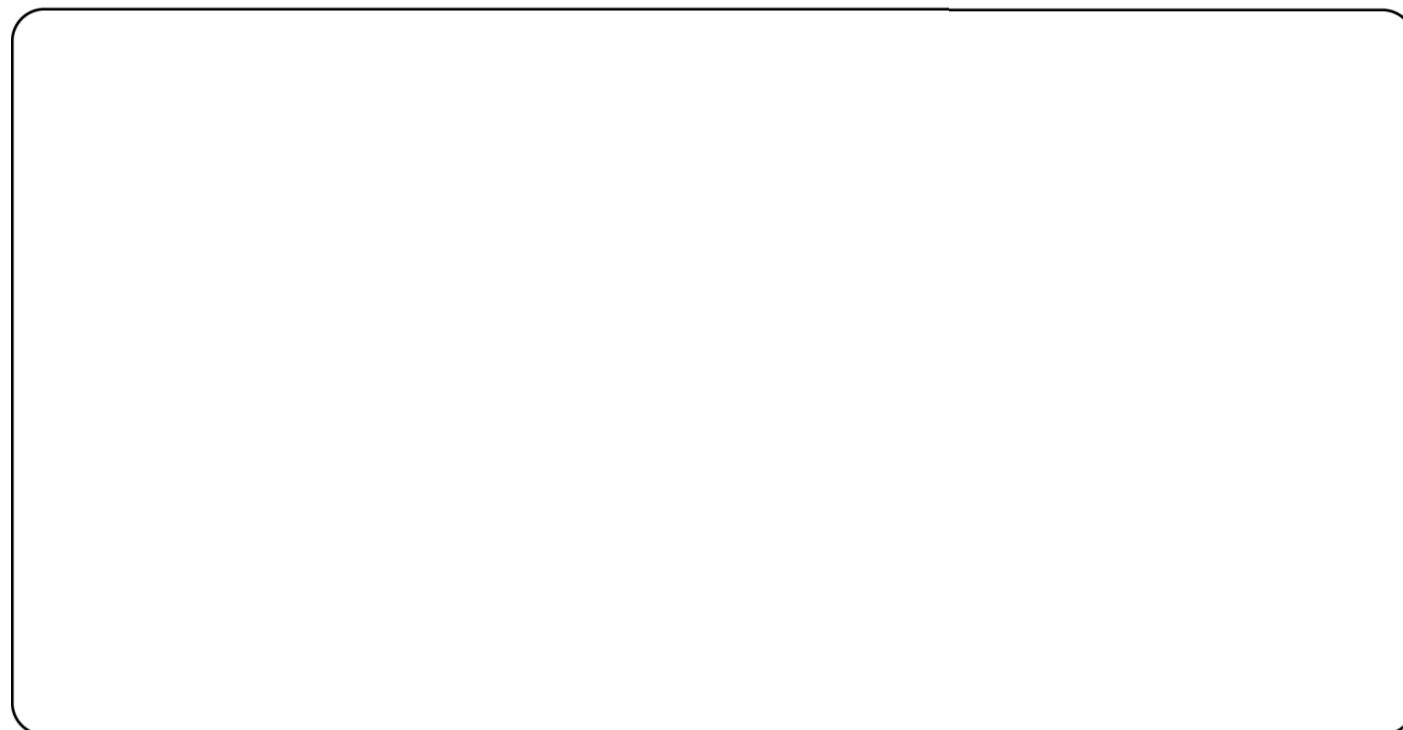

# Face

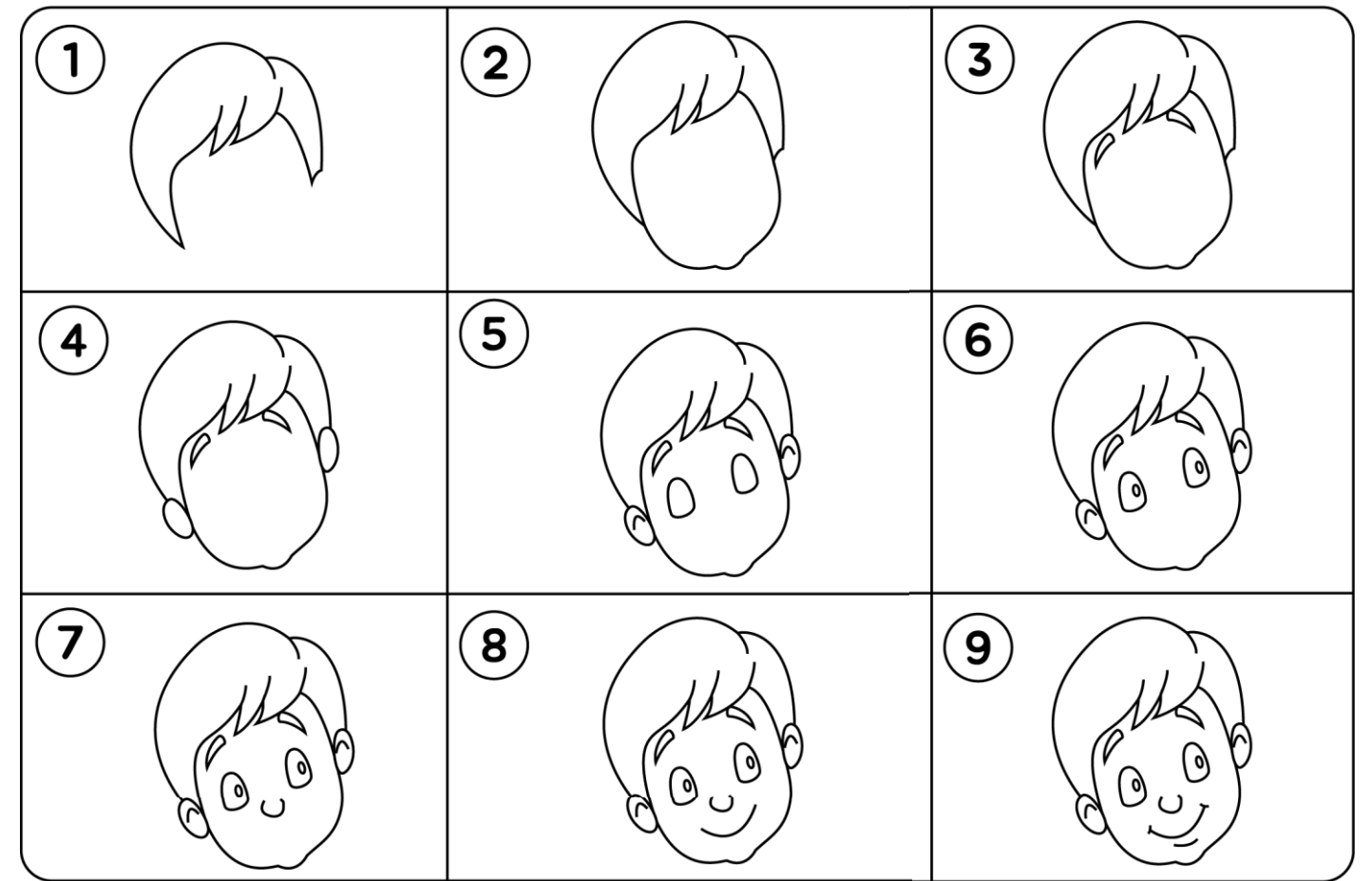

## Practice

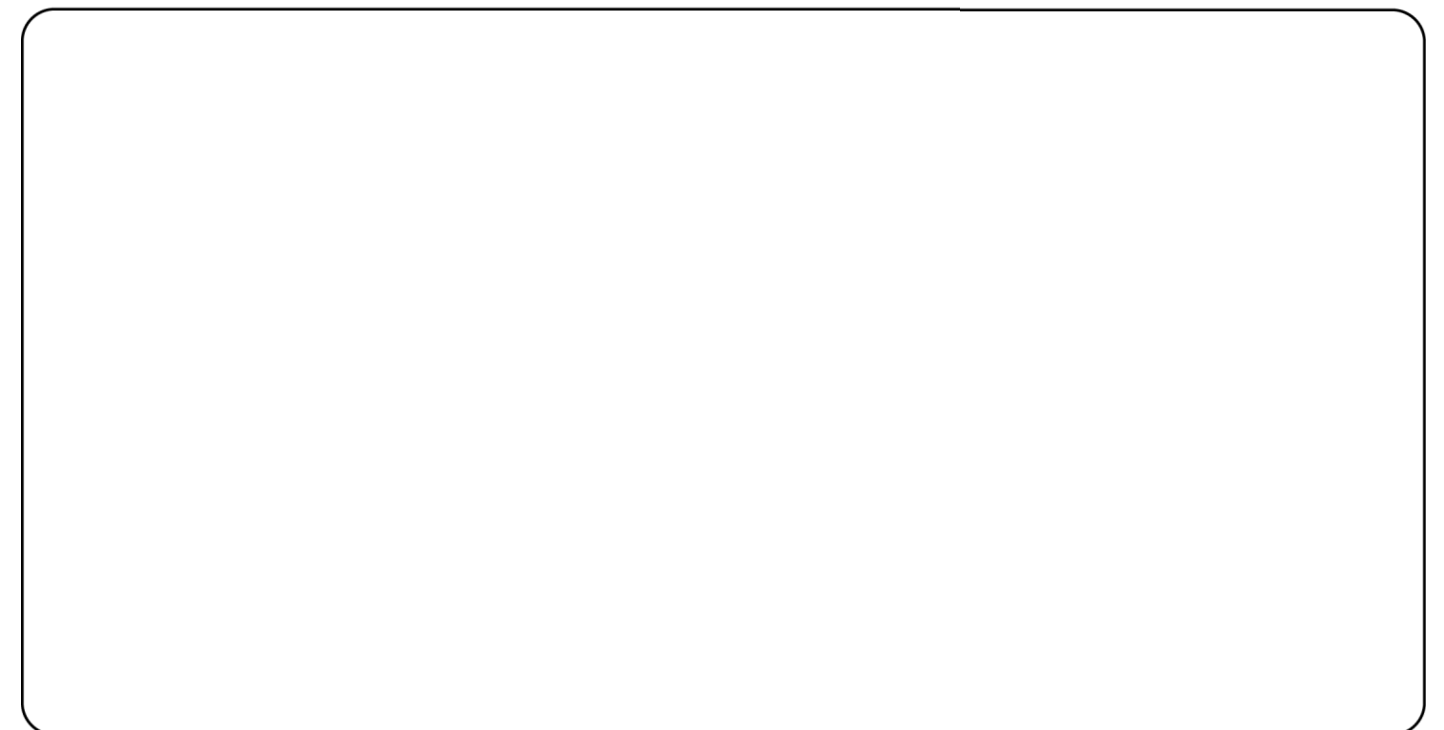

# Cupcake

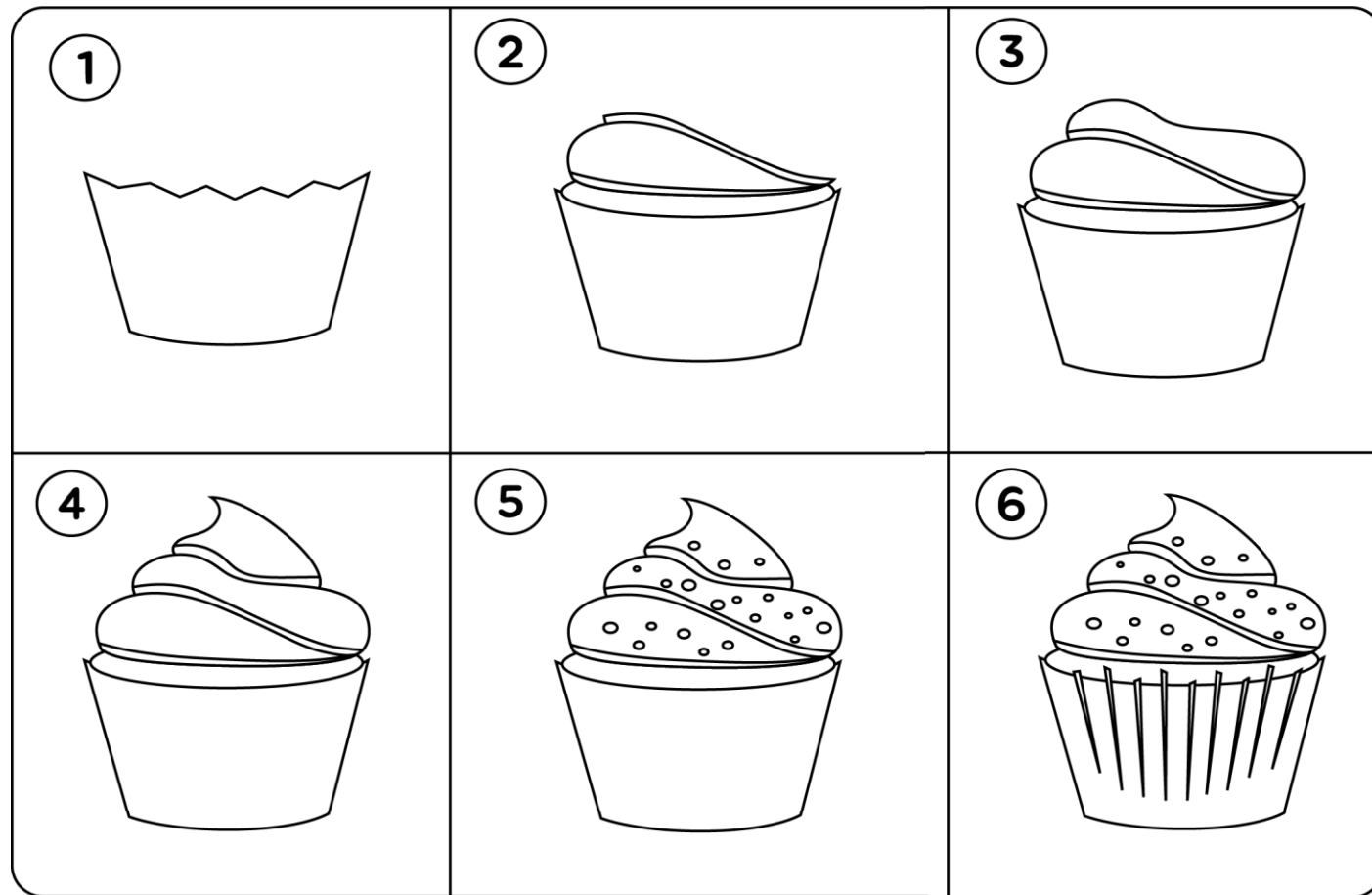

## Practice

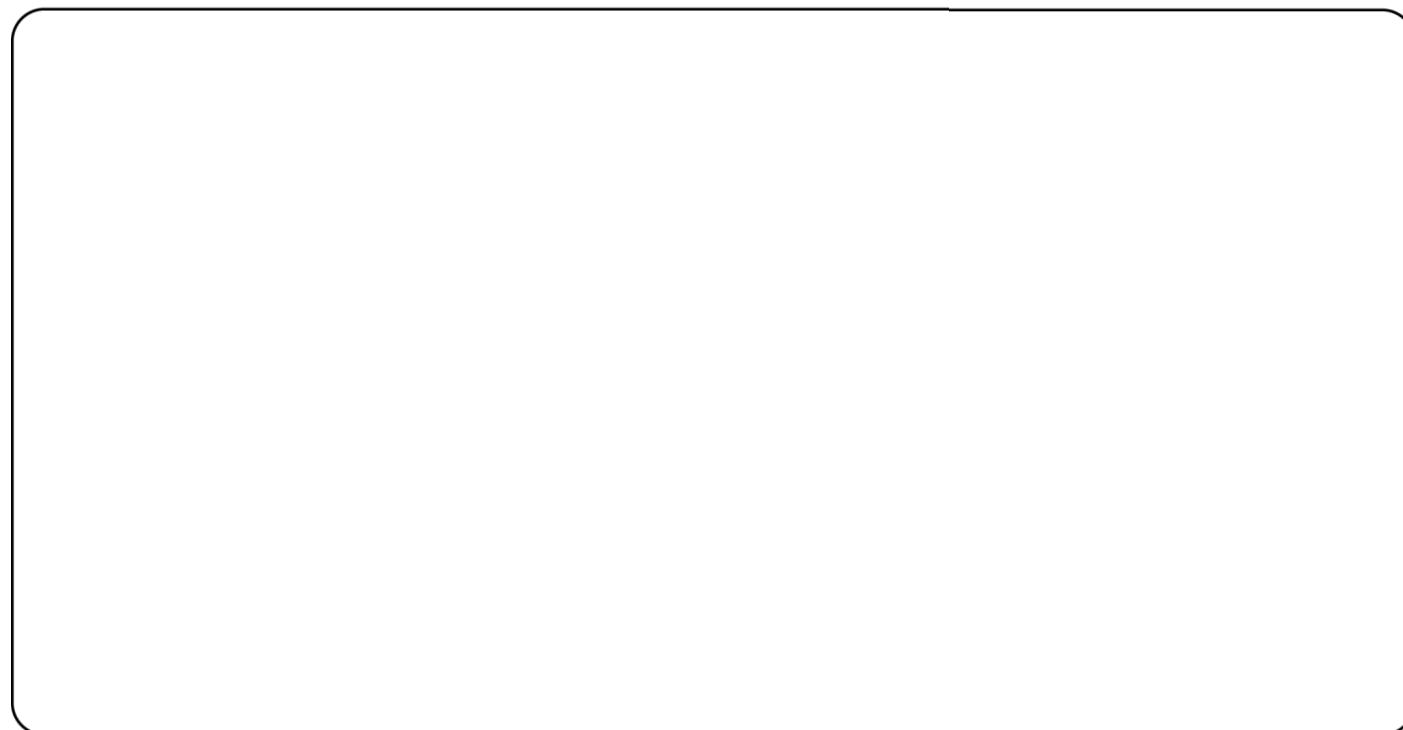

# Train

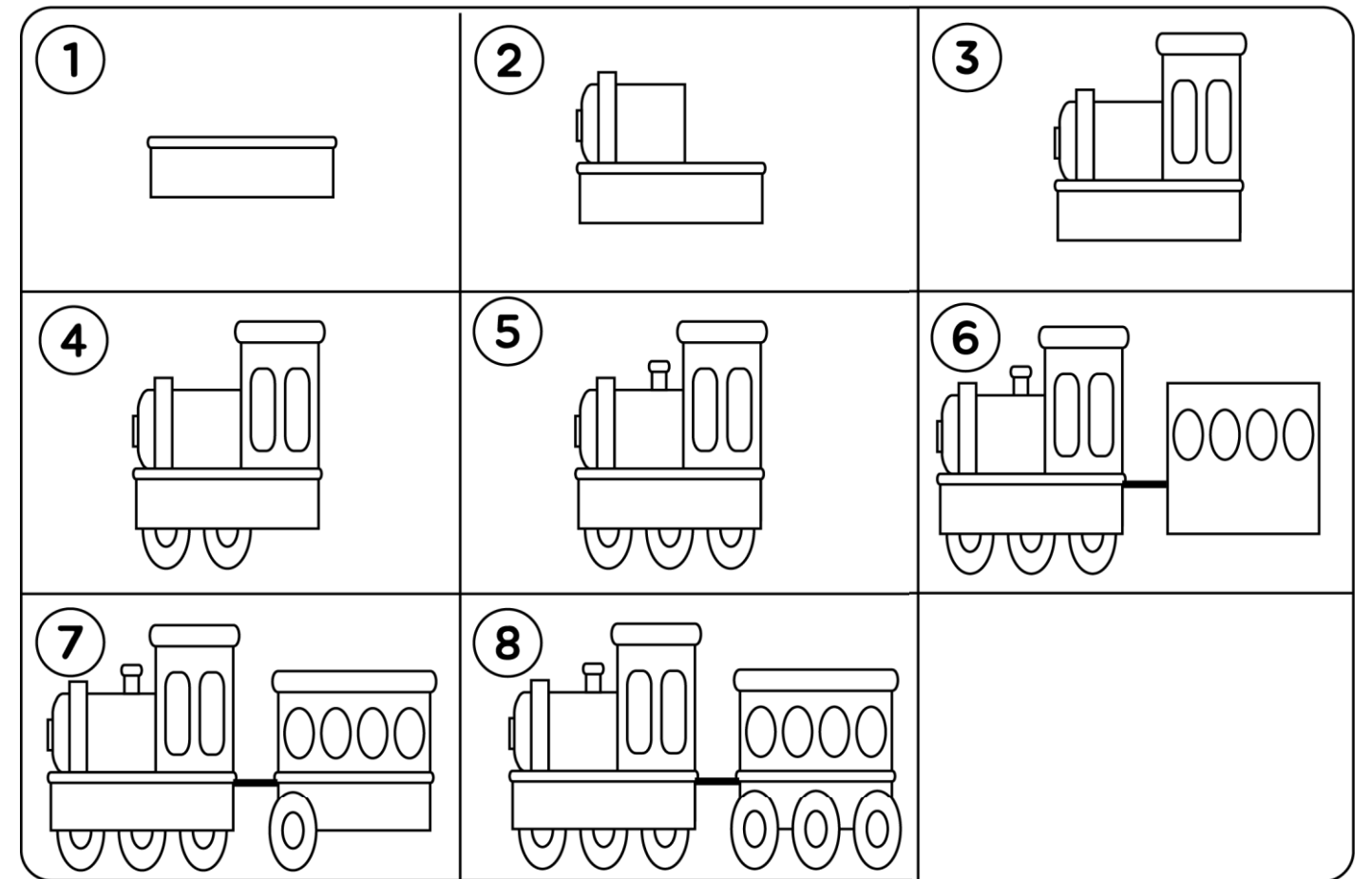

## Practice

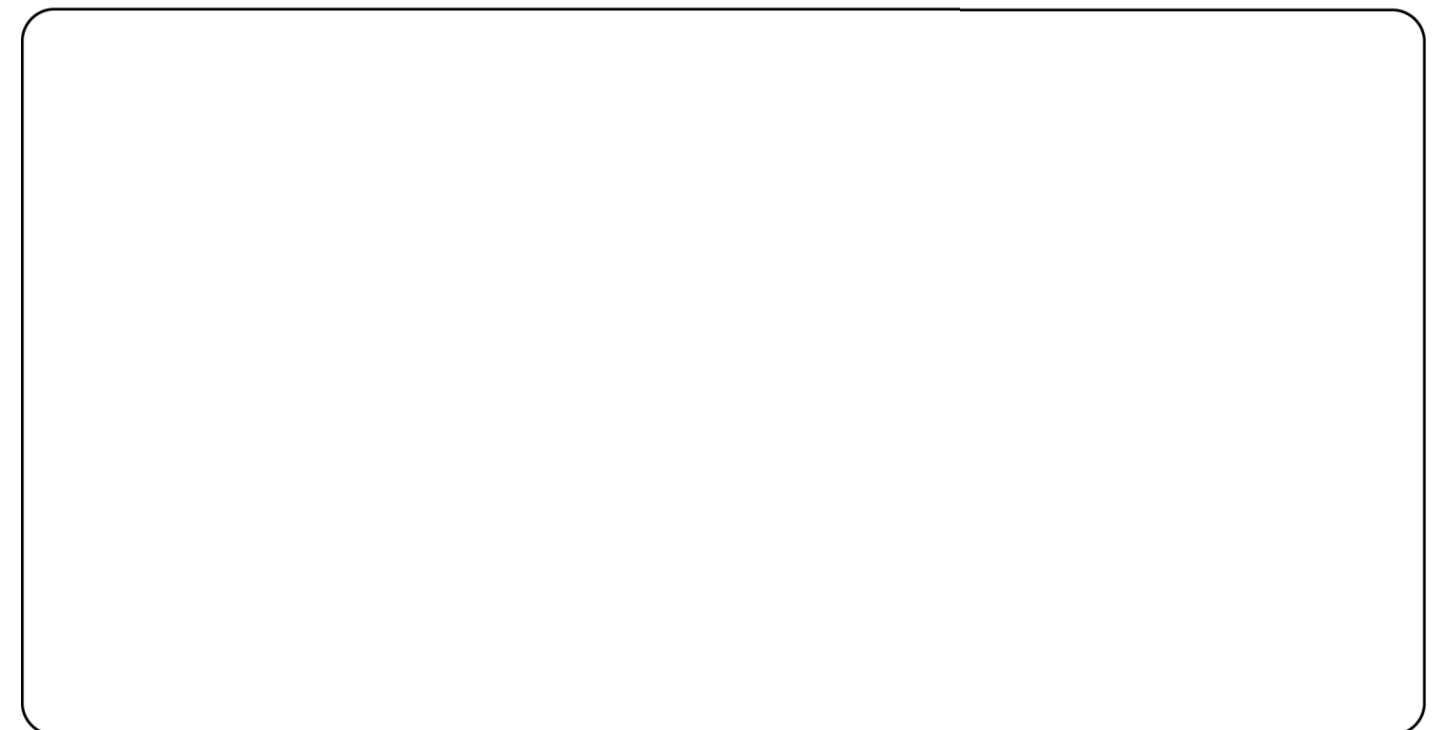

# Meerkat

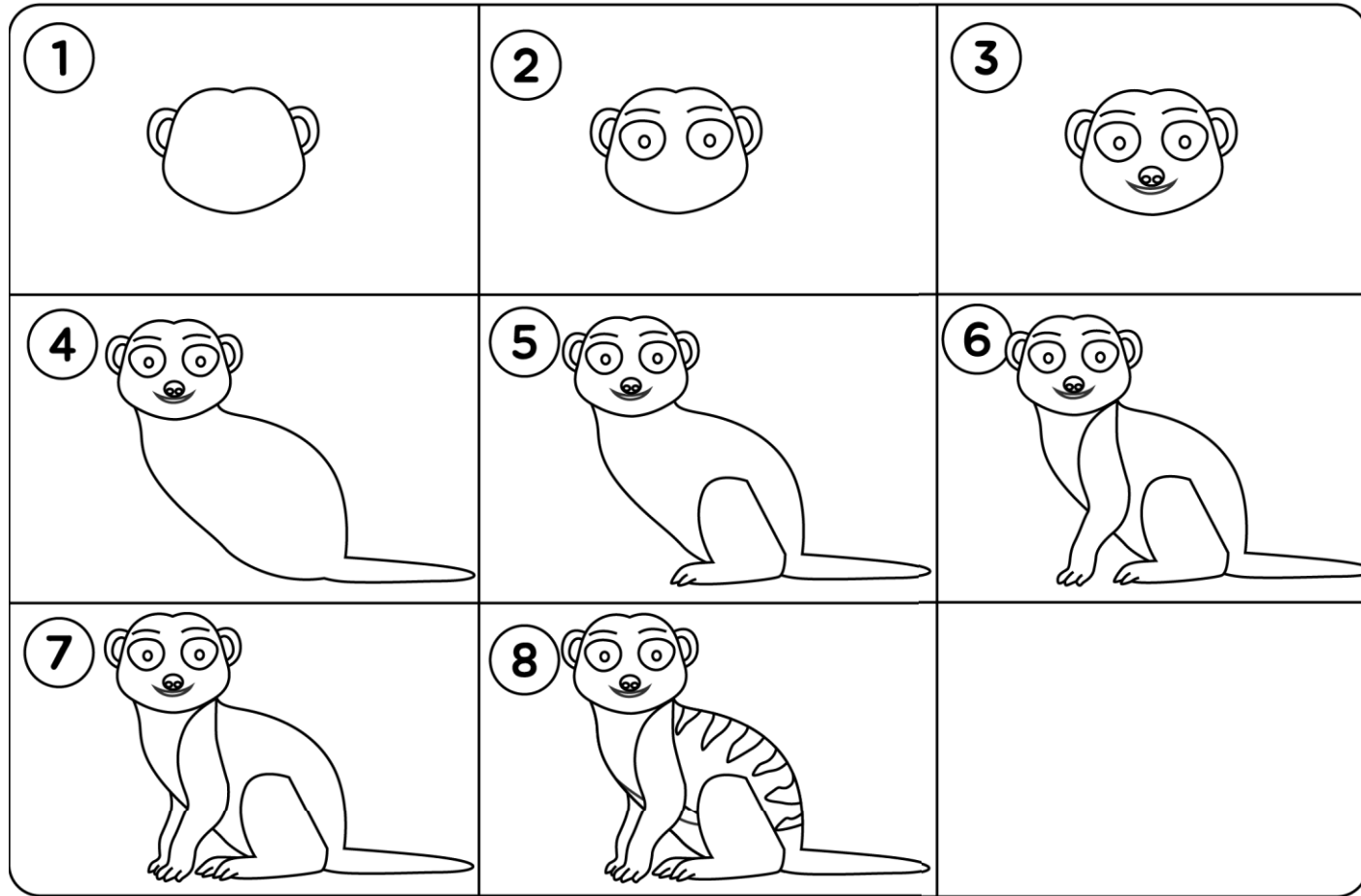

# Practice

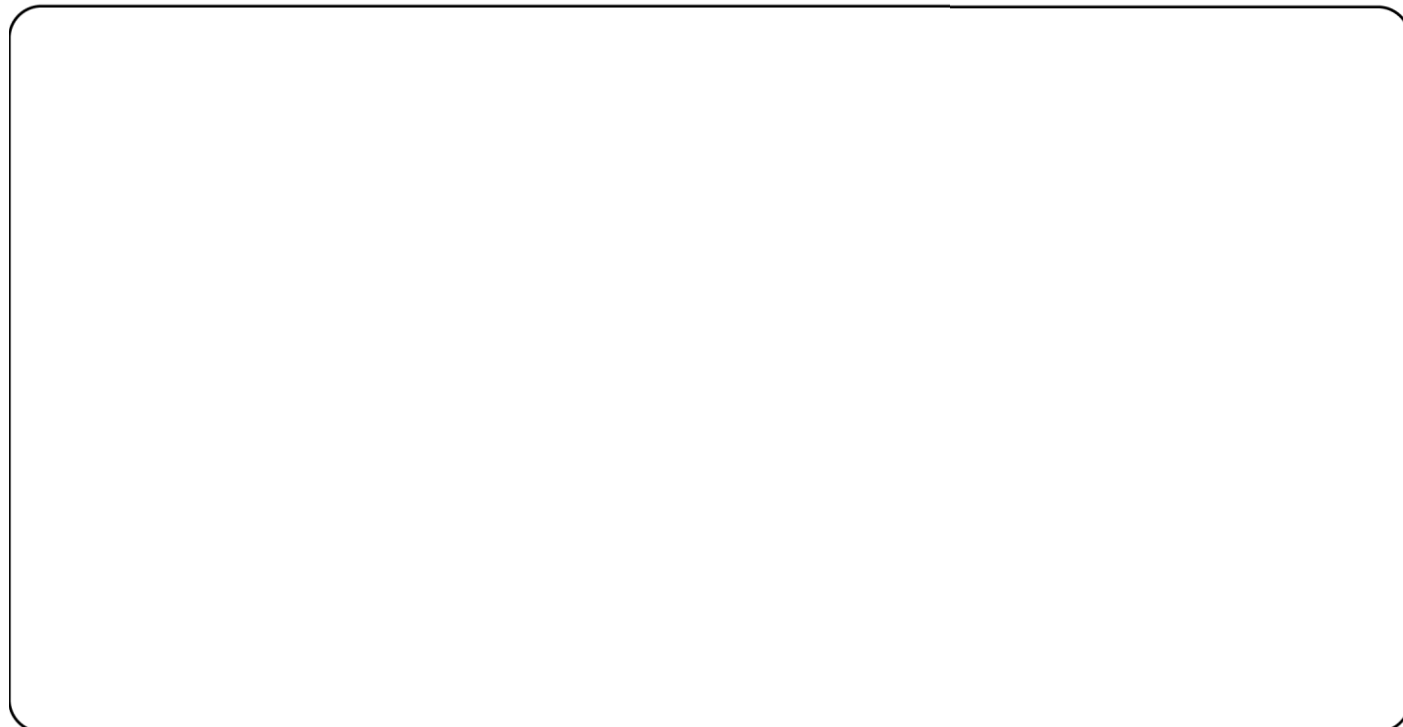

# Fire

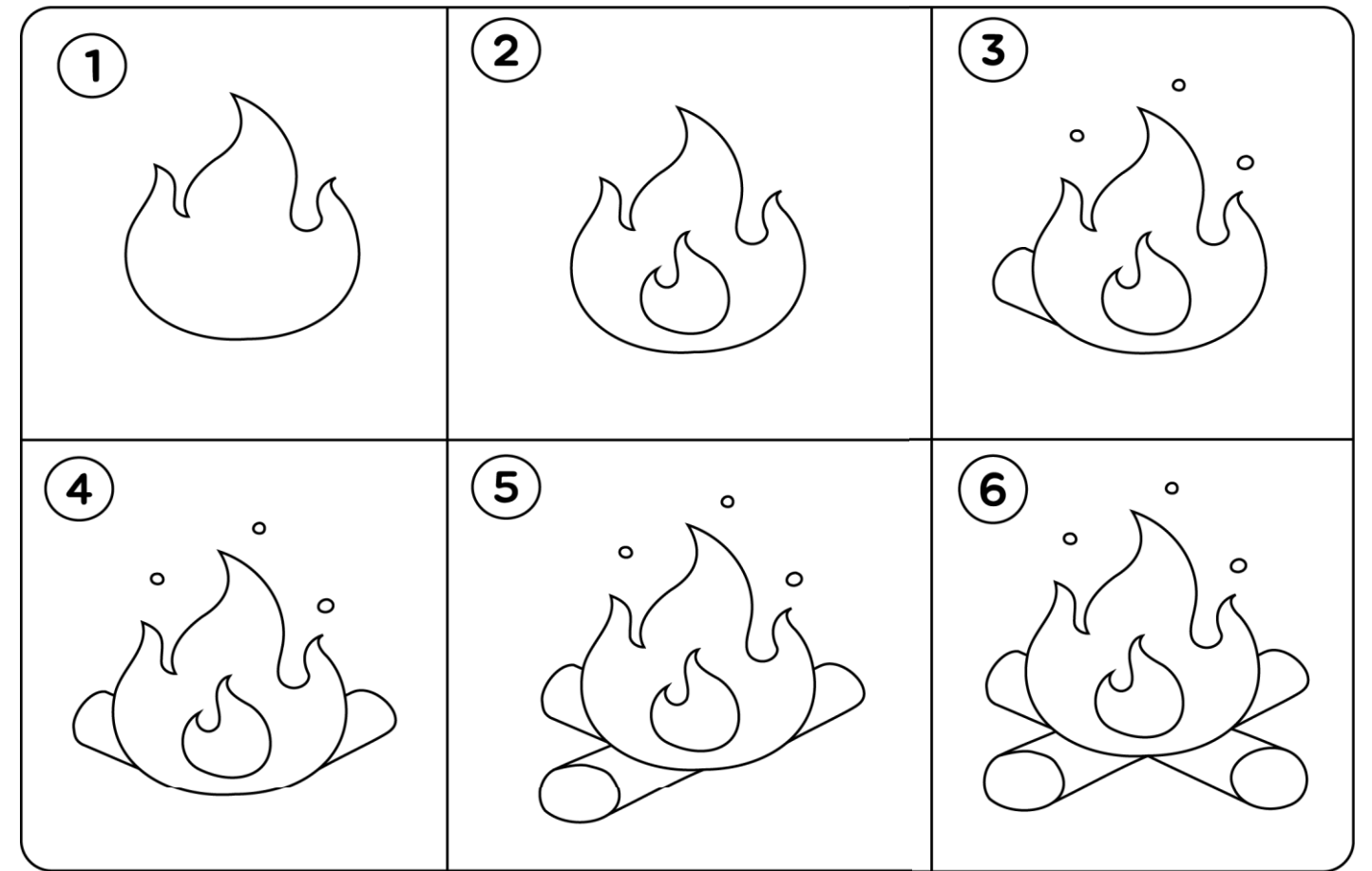

# Practice

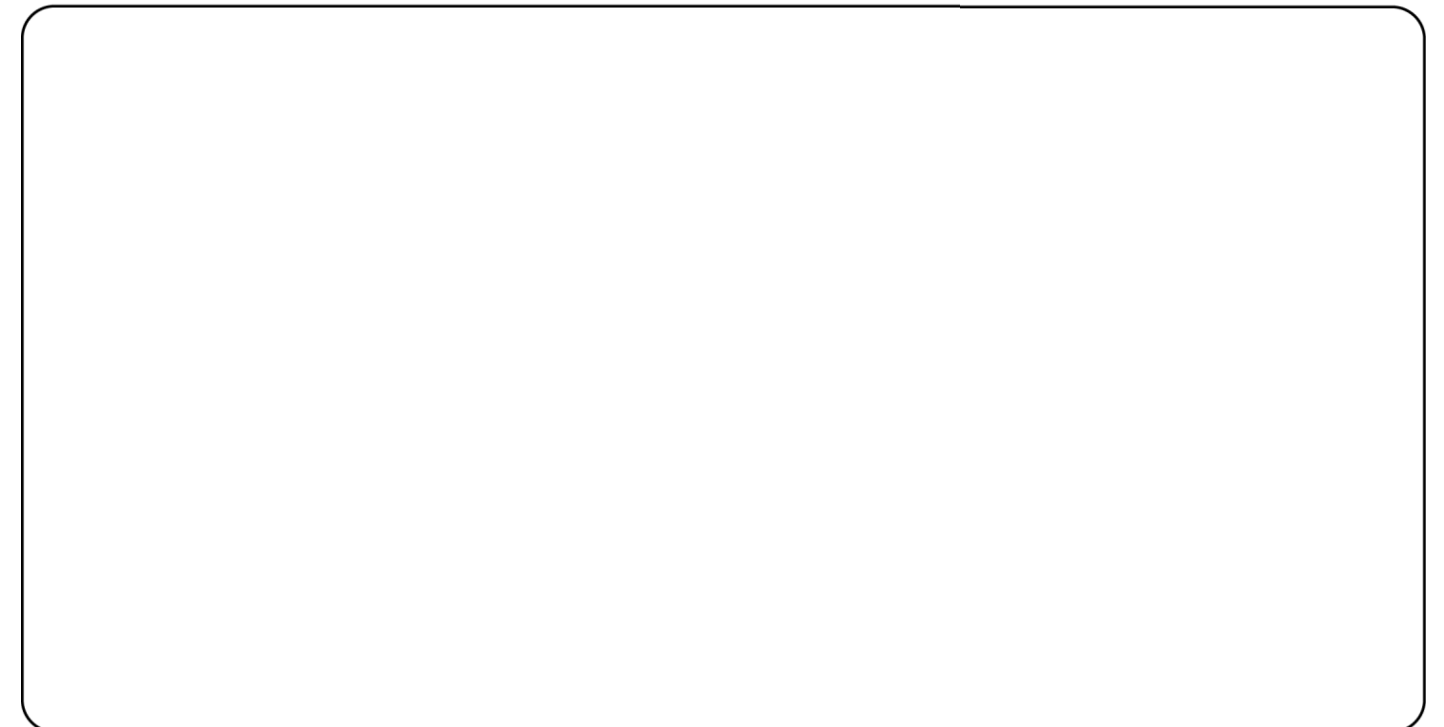

## Capybara

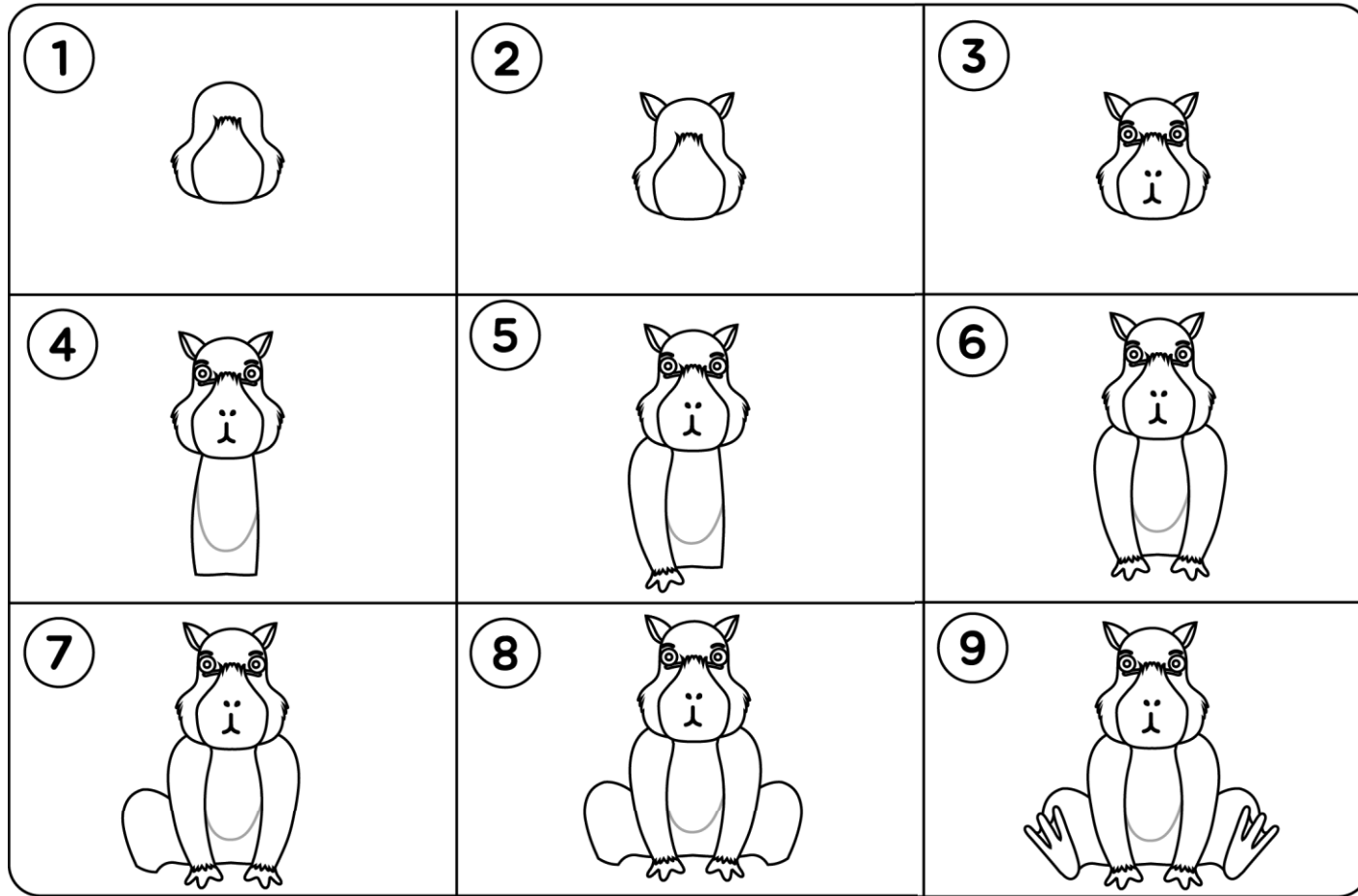

## Practice

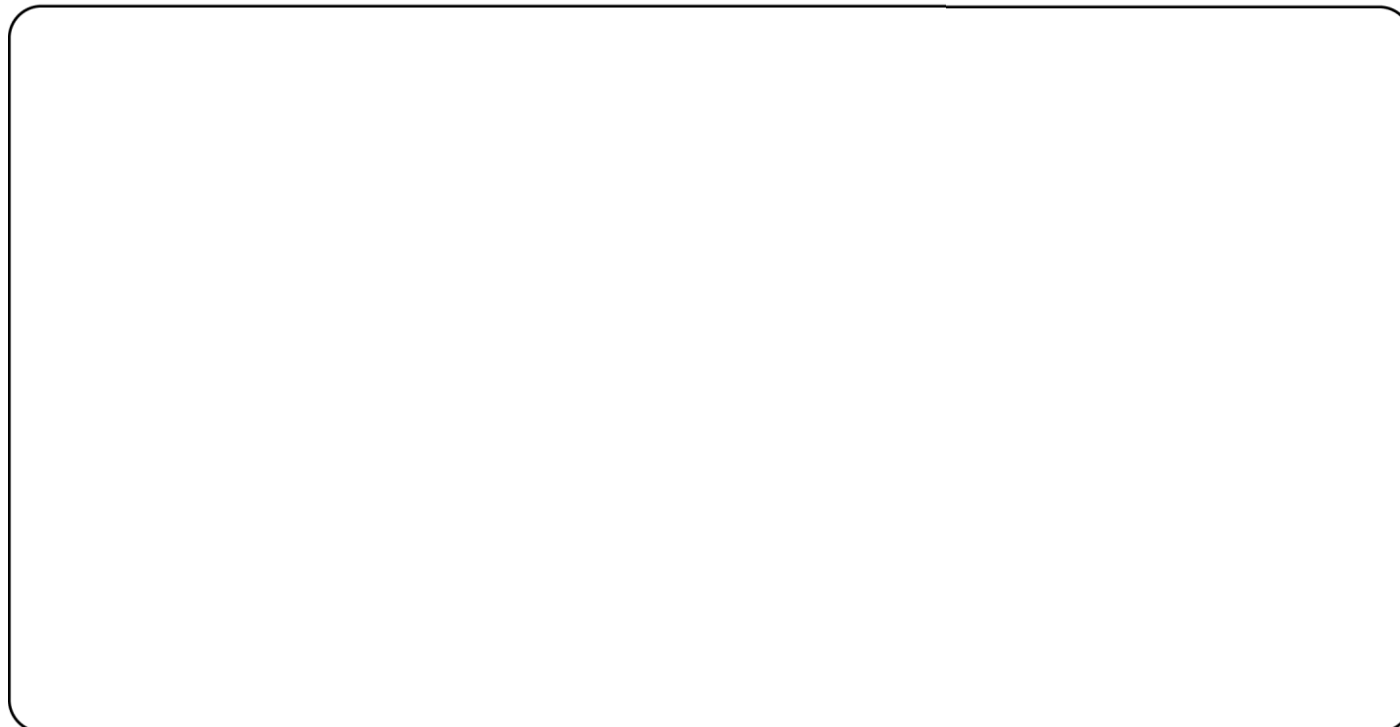

## Garlic

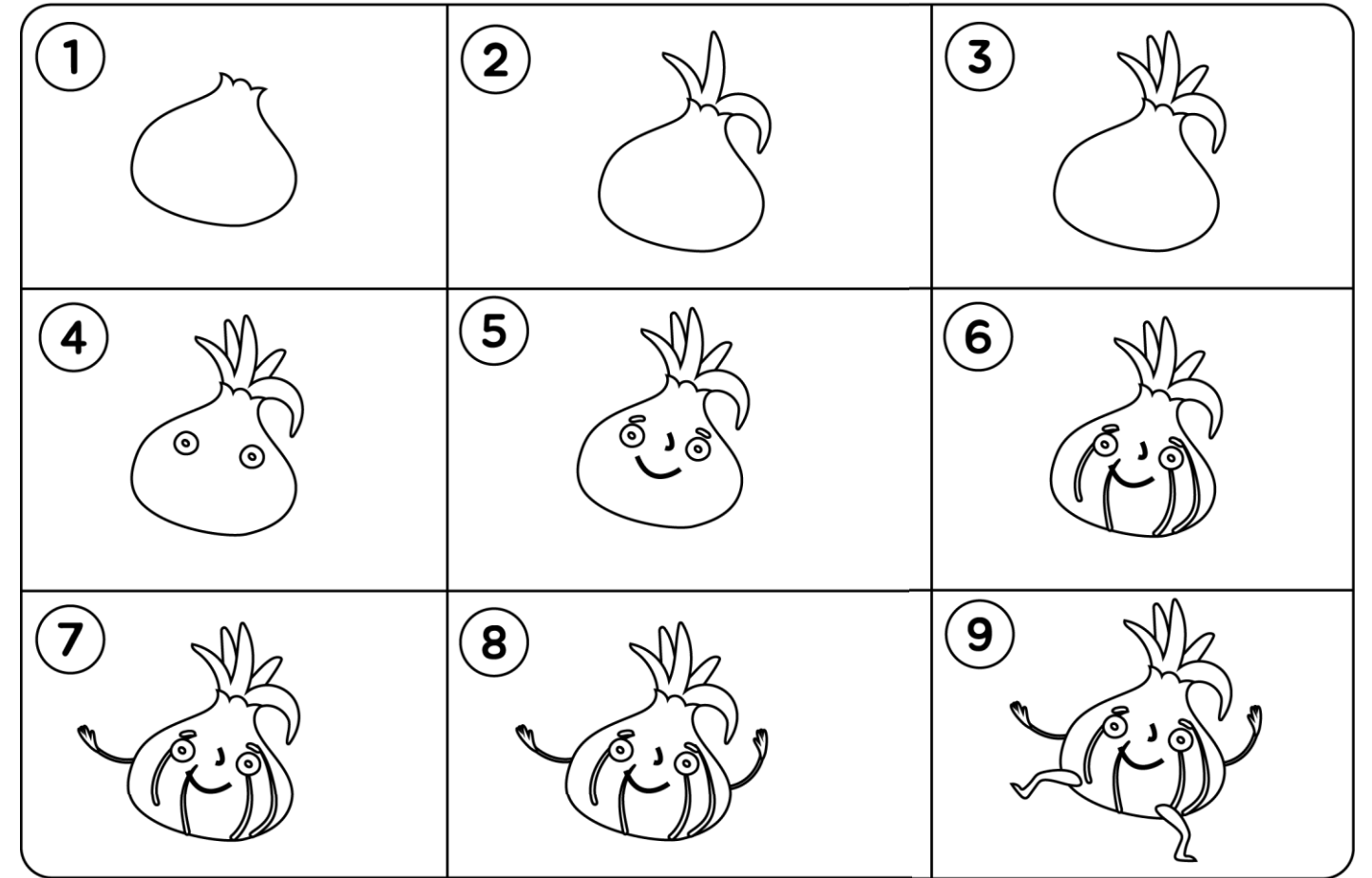

## Practice

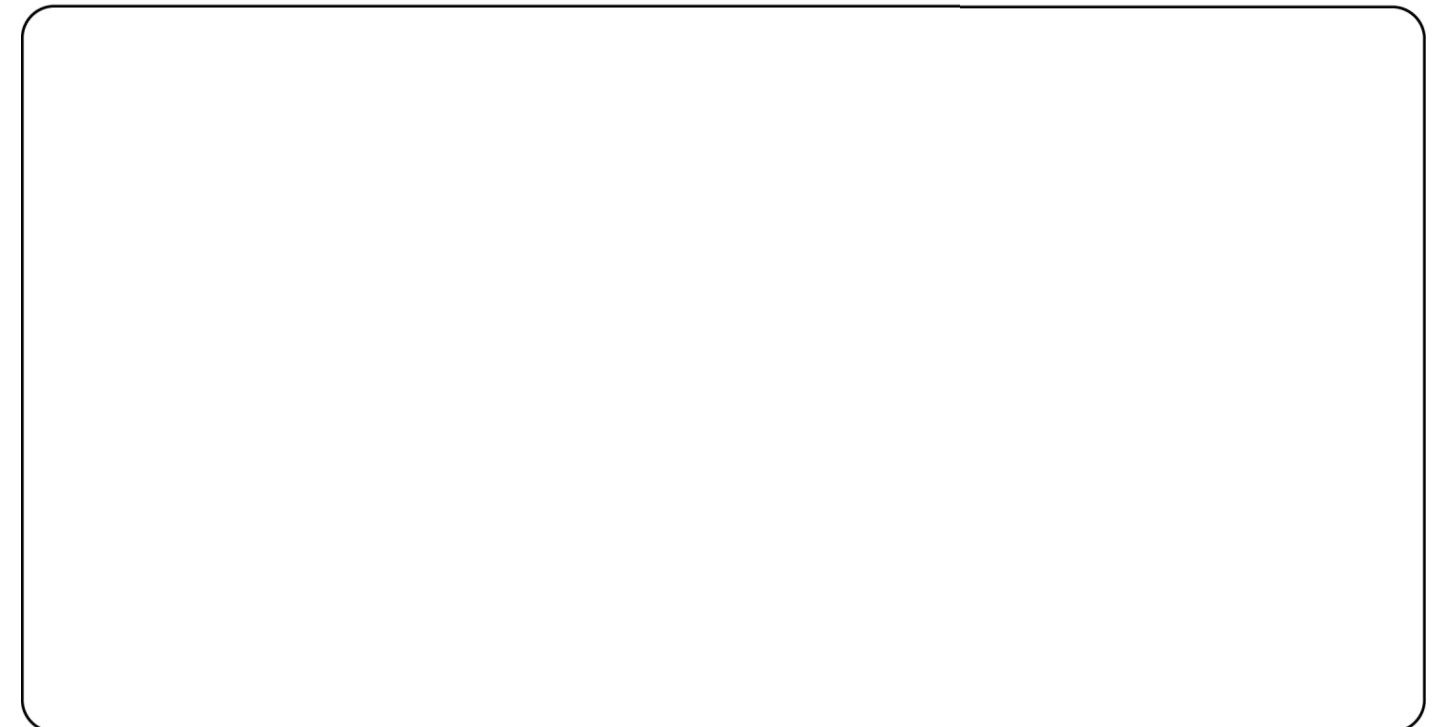

# Monster Truck

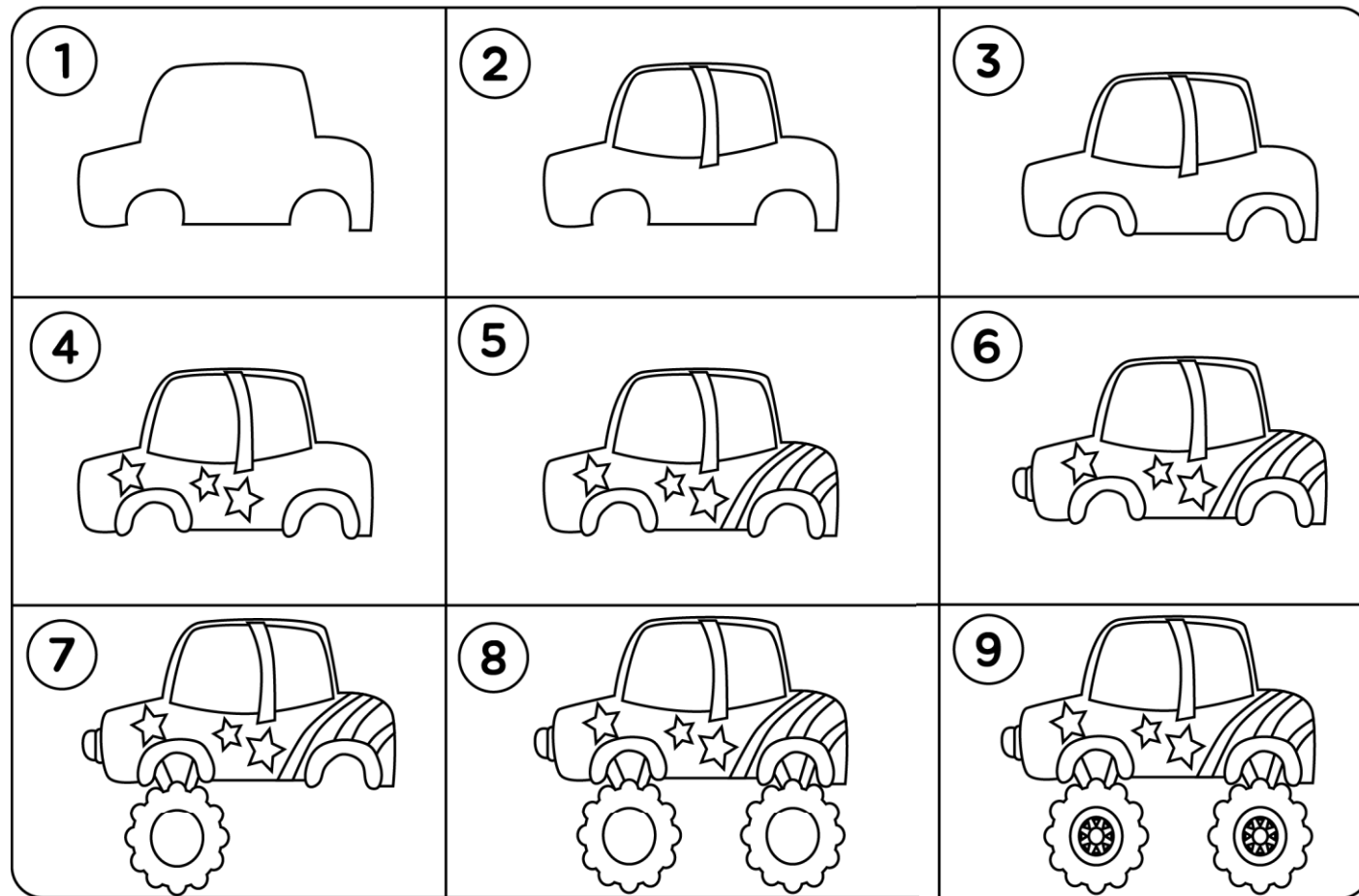

## Practice

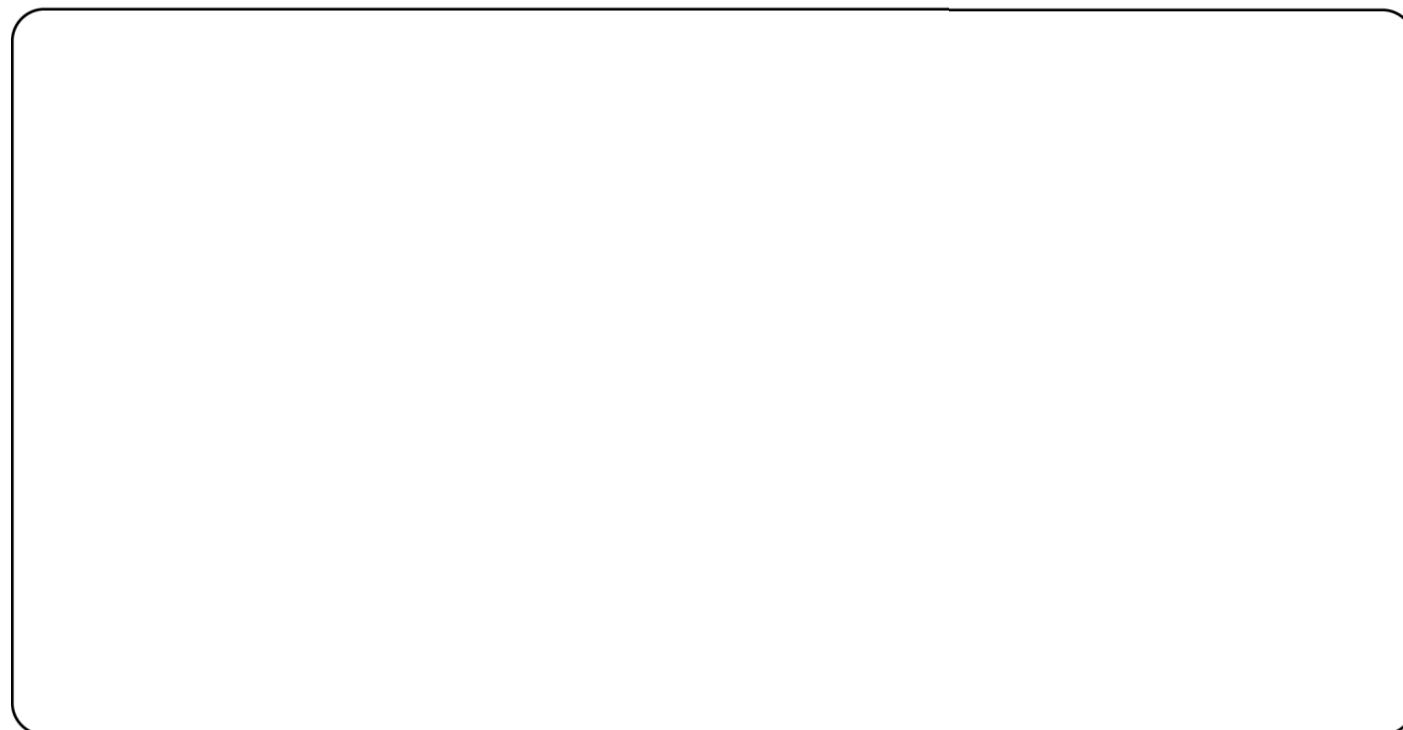

# Flower

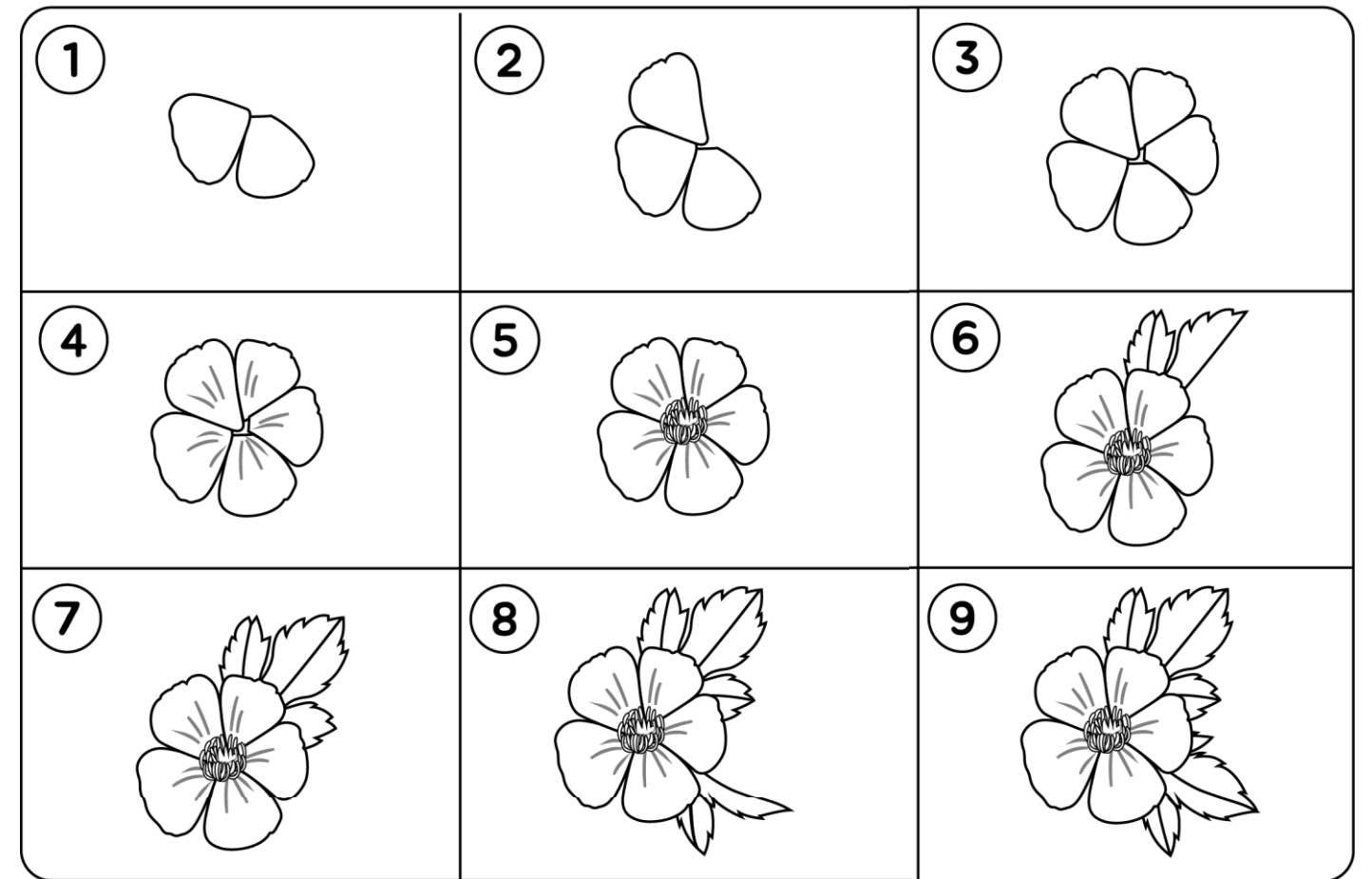

## Practice

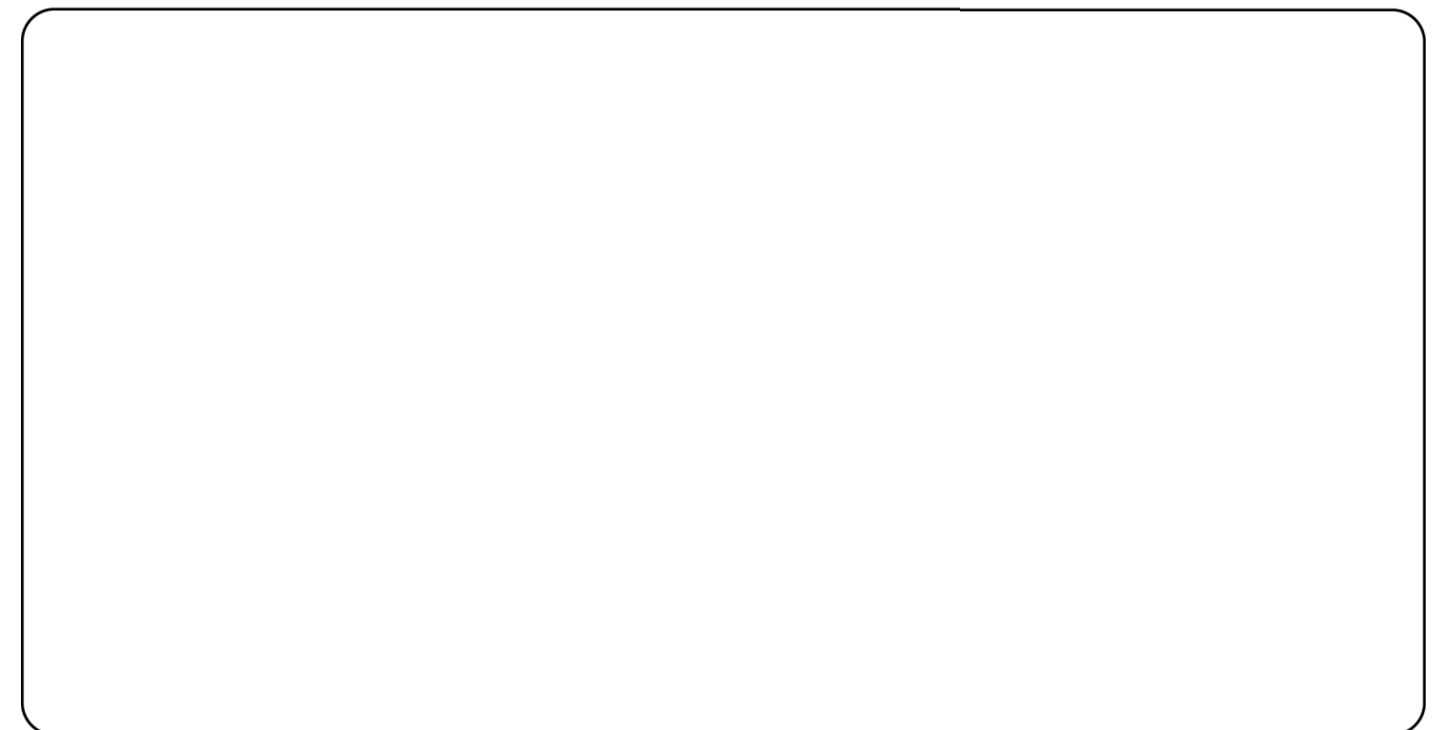

# Girl

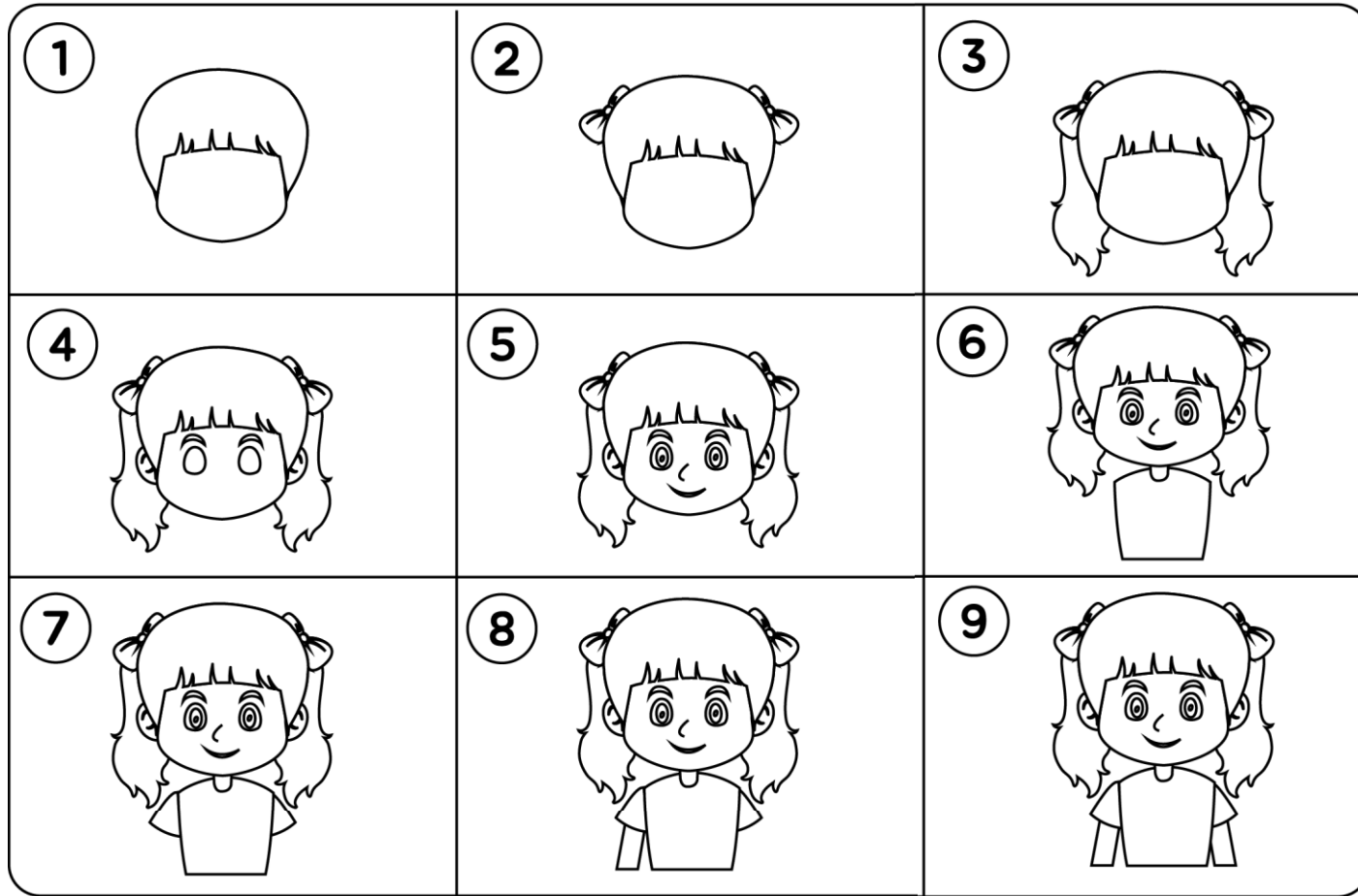

# Practice

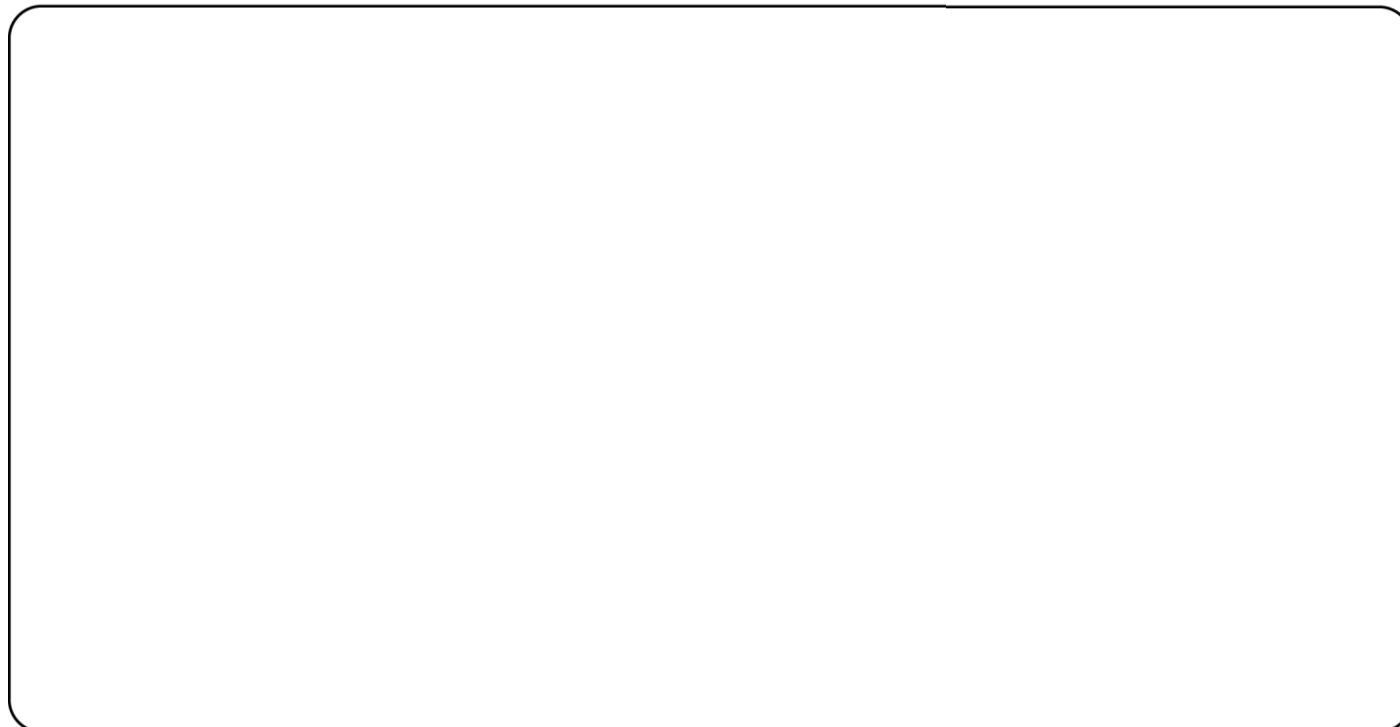

# Ostrich

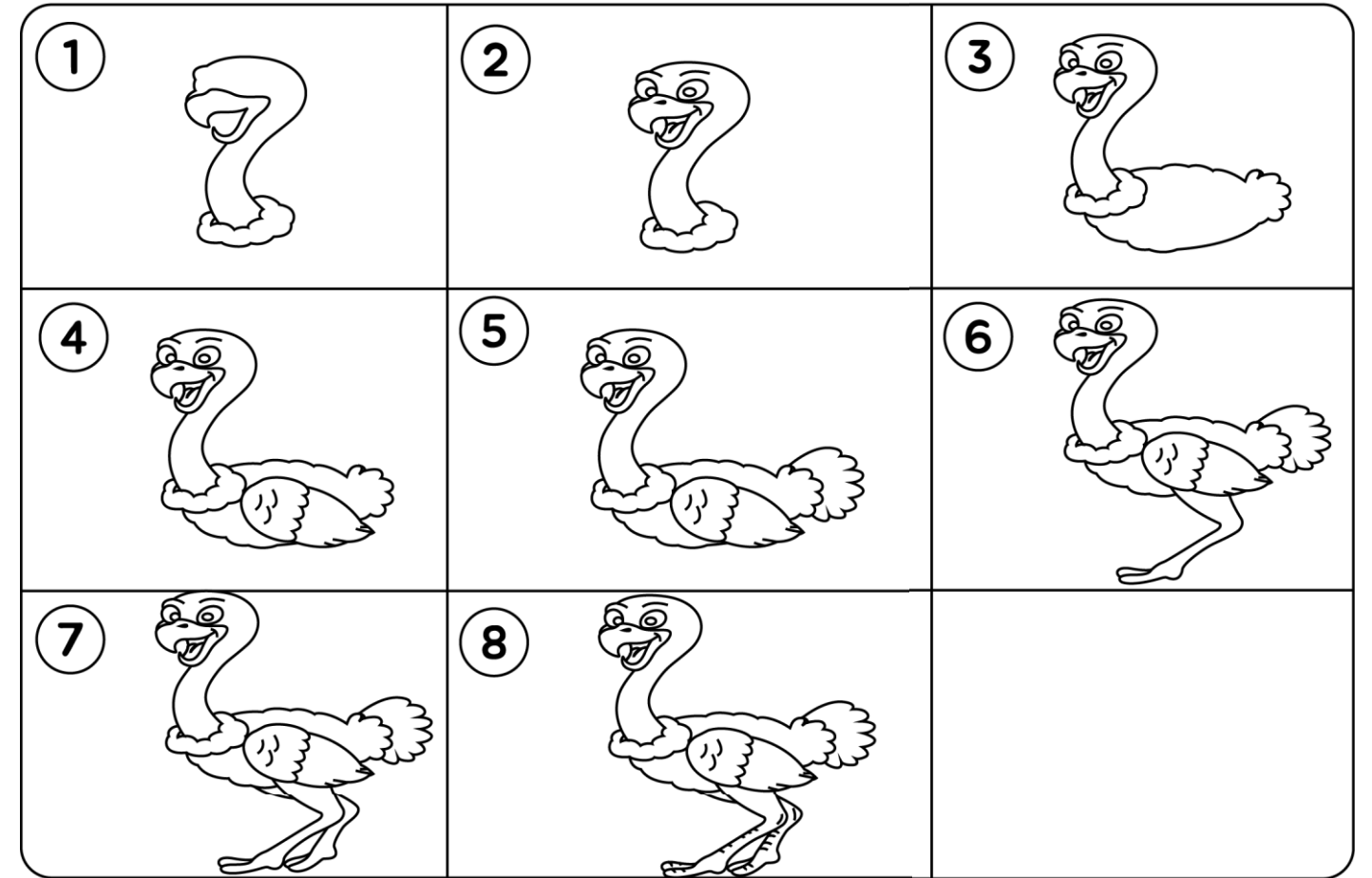

# Practice

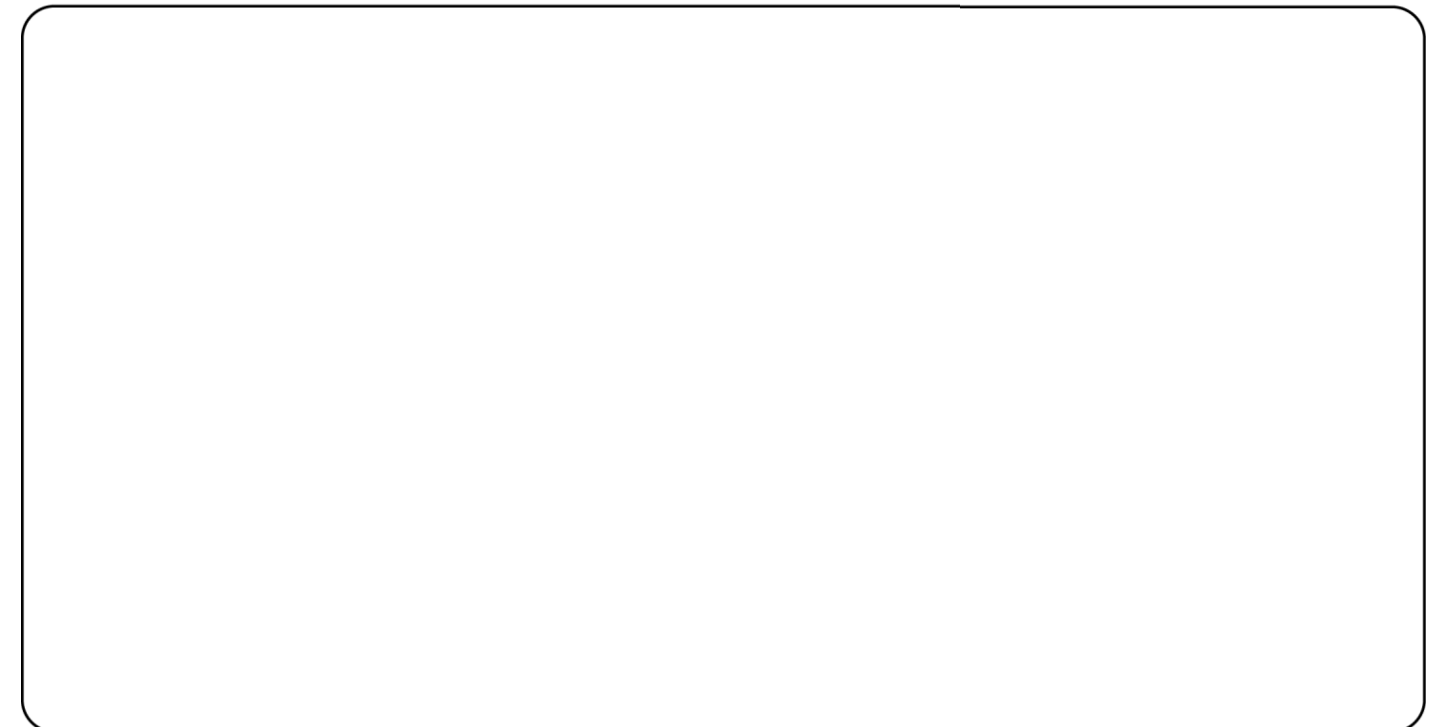

# Plane

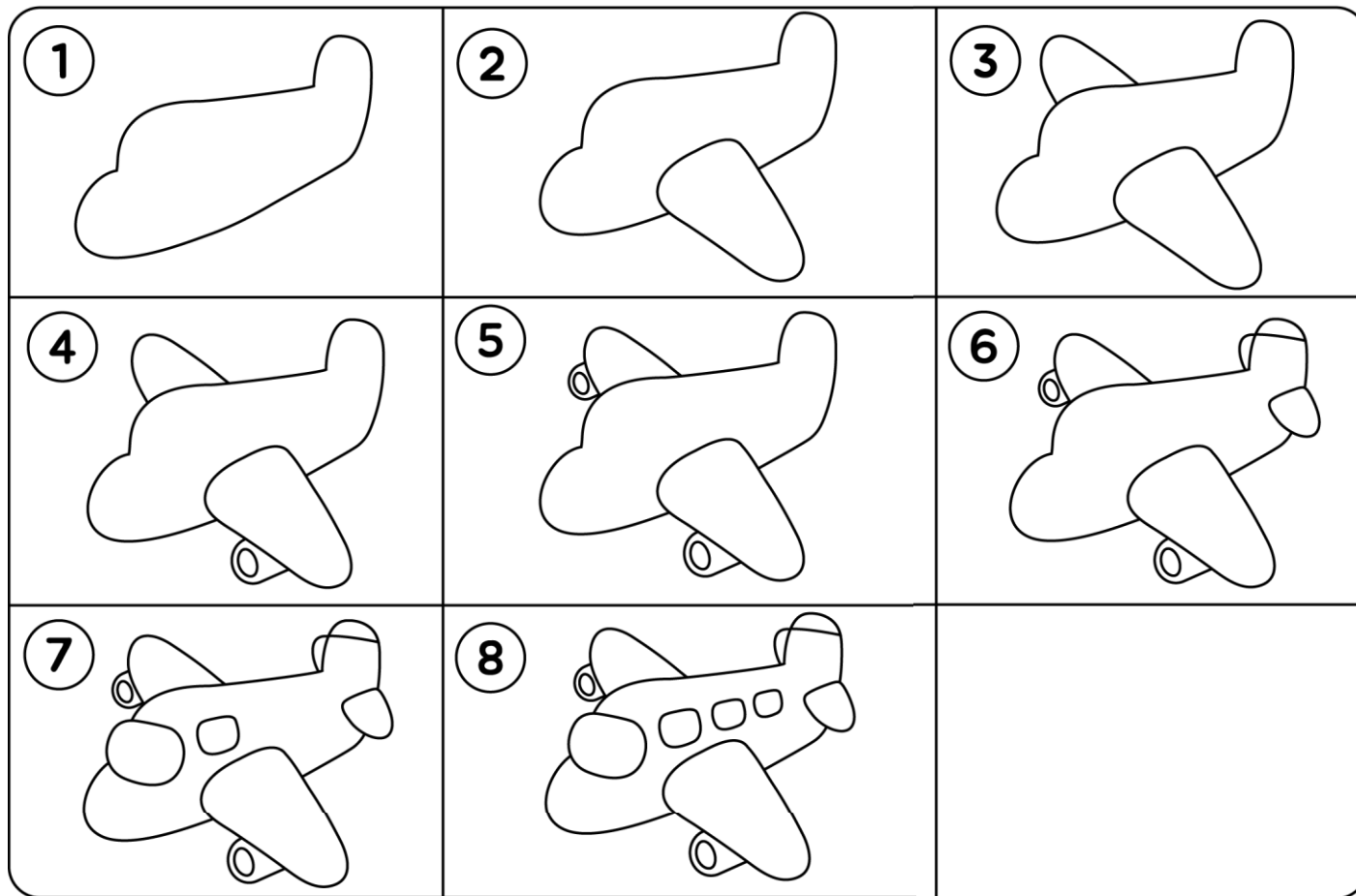

# Practice

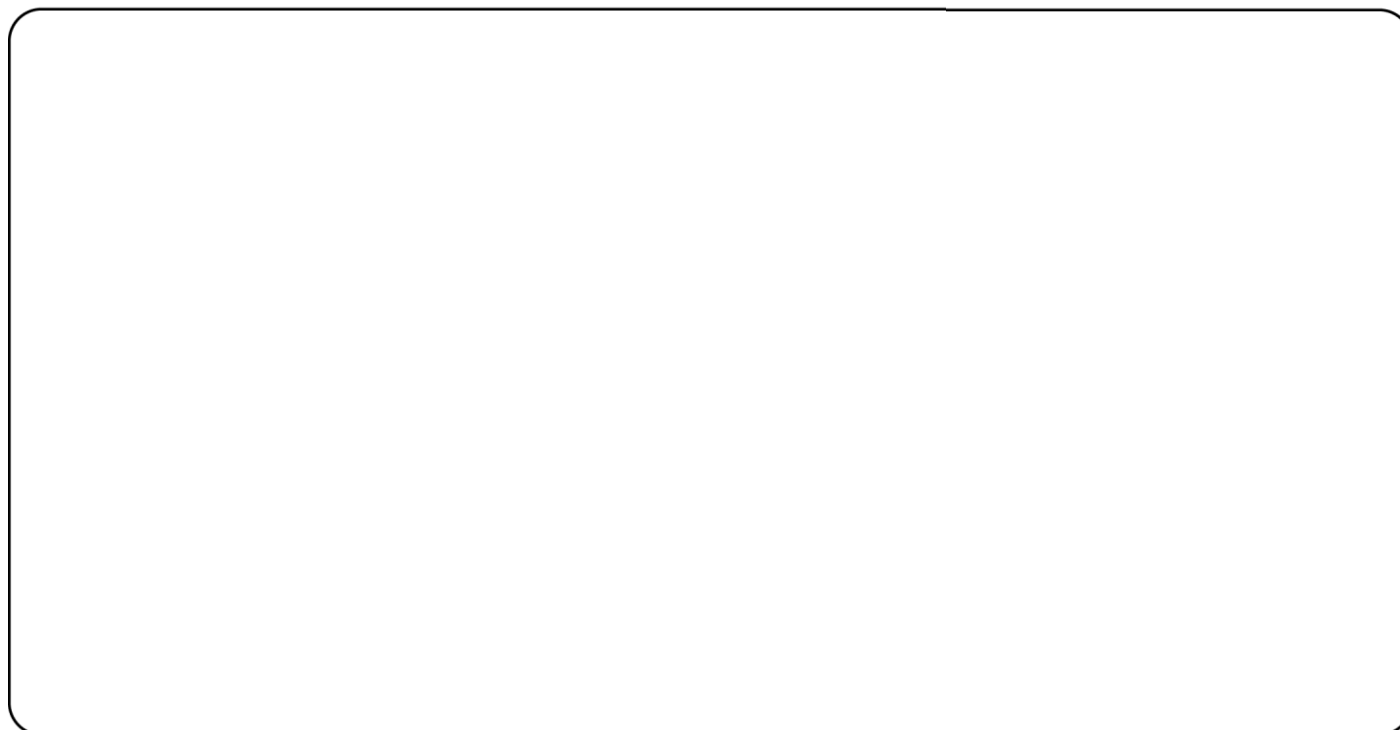

# Duck

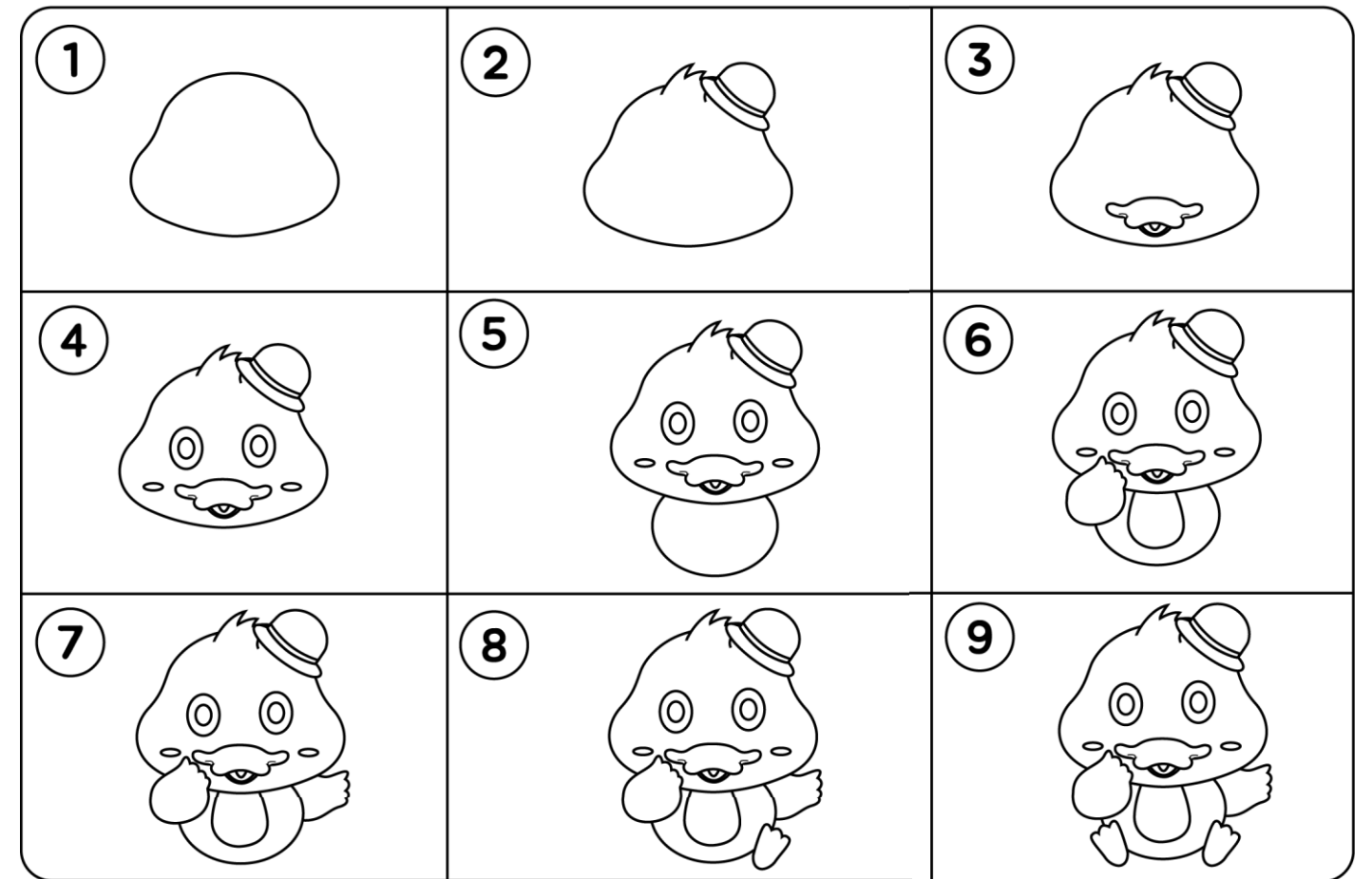

# Practice

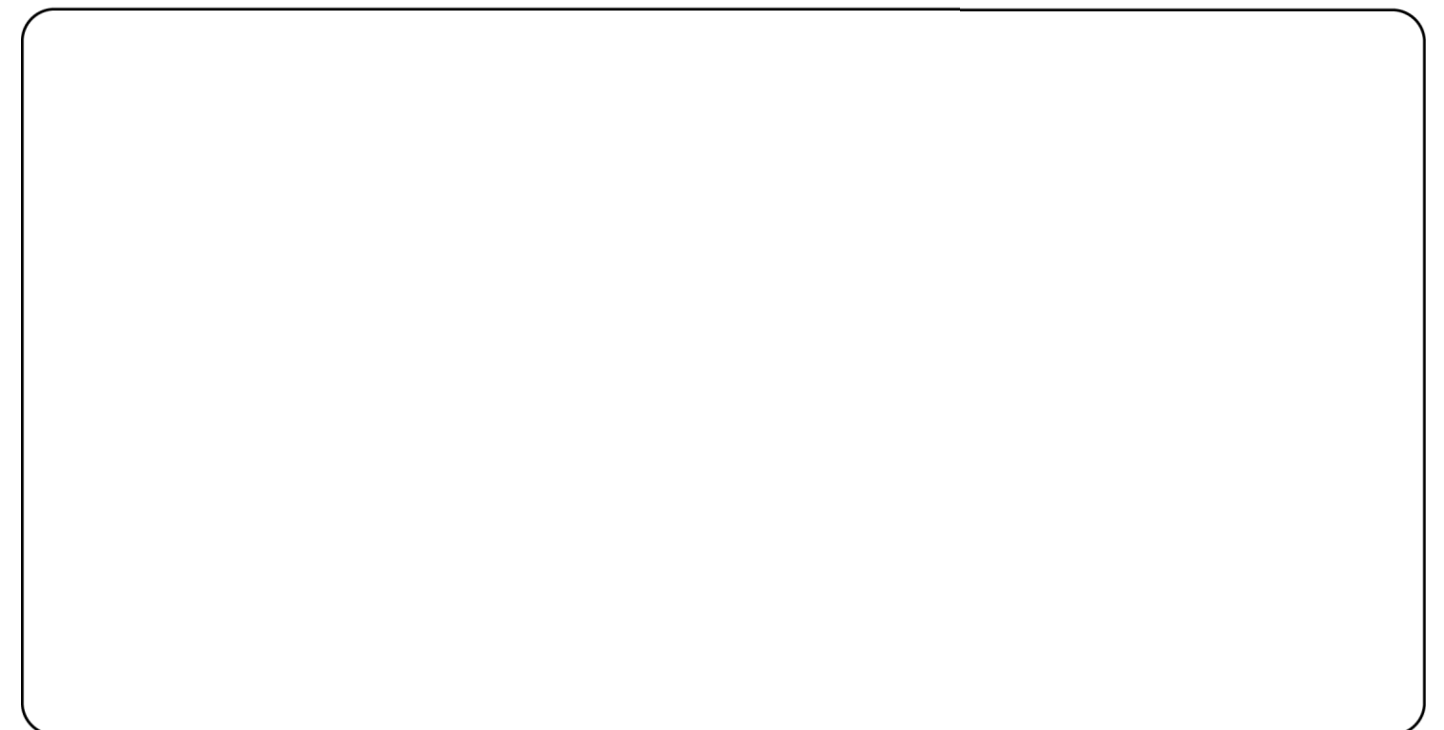

# Globe

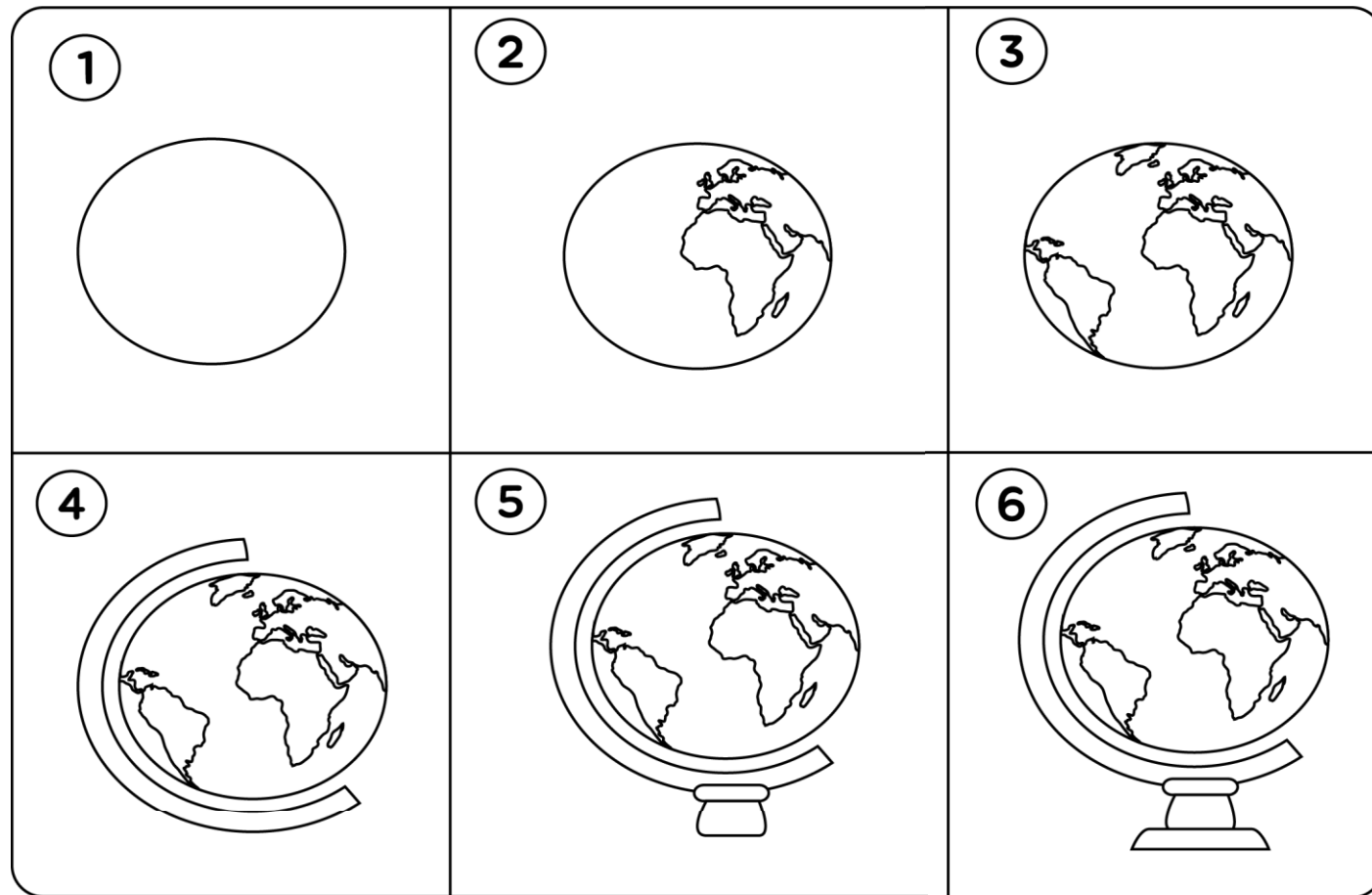

## Practice

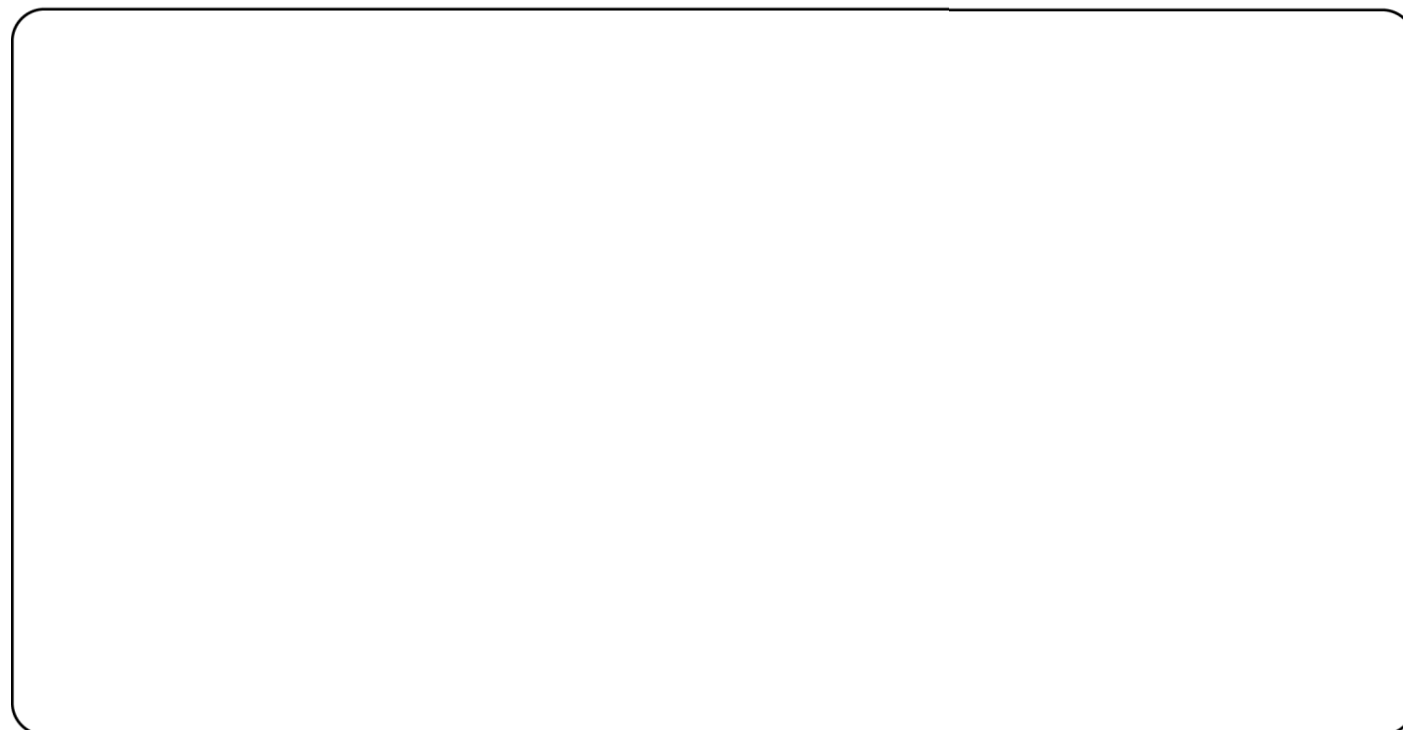

# Hedgehog

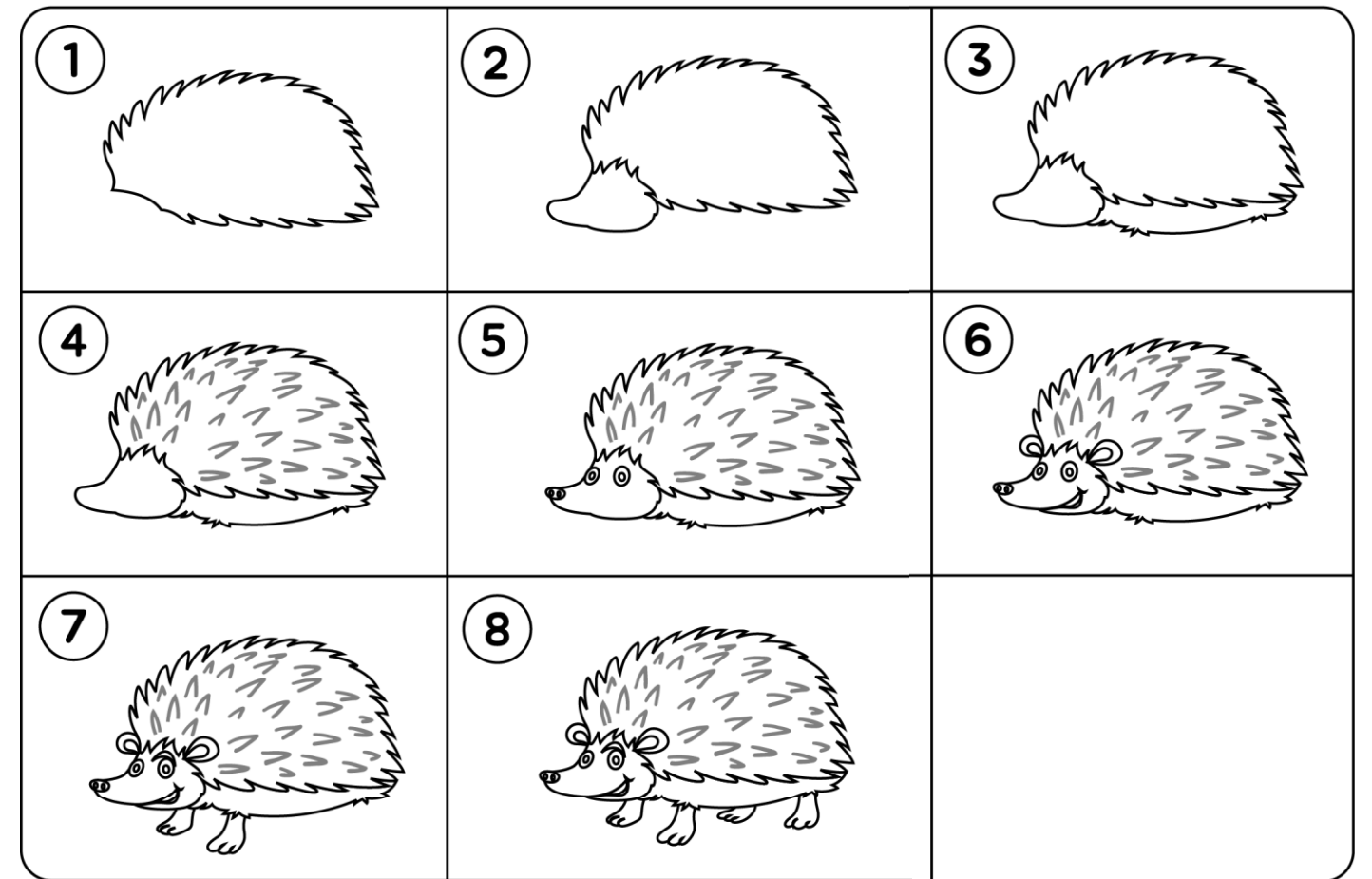

## Practice

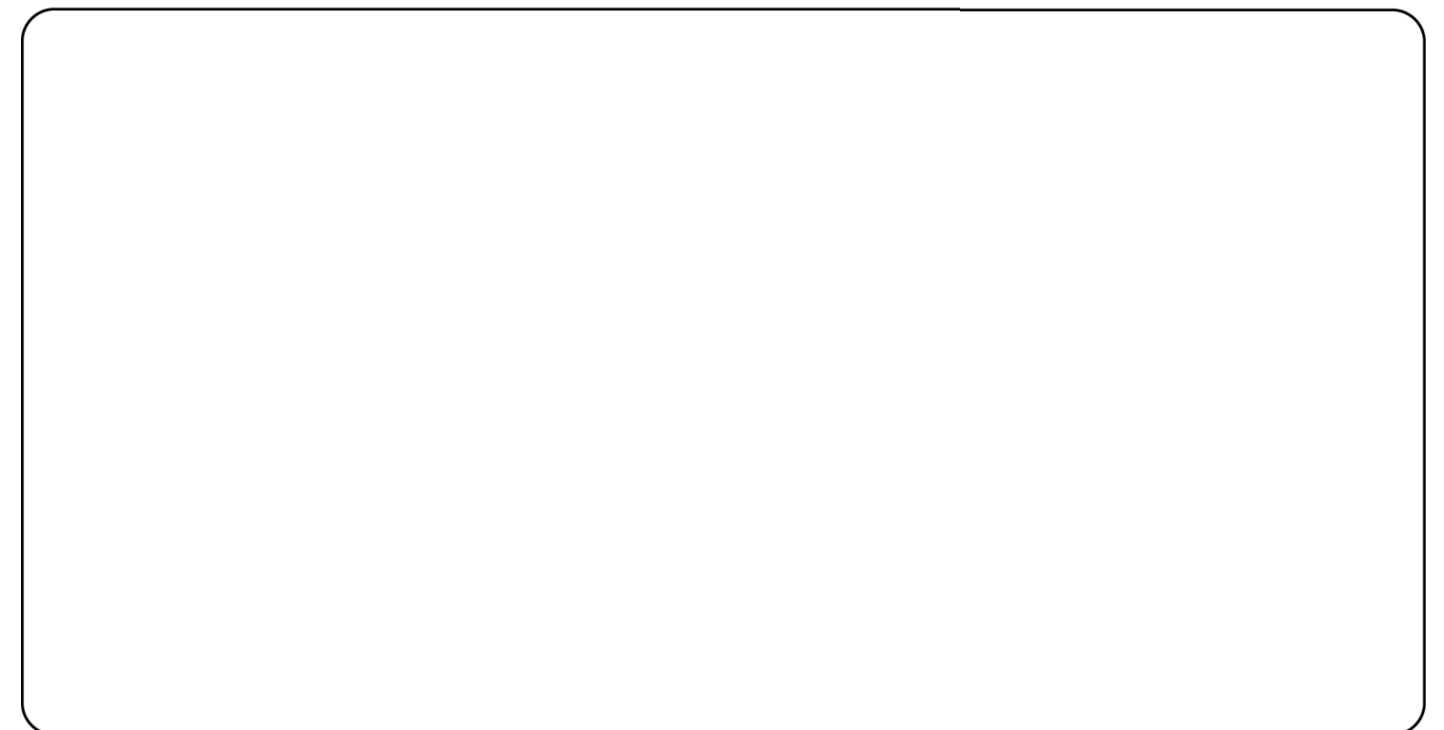

# Donkey

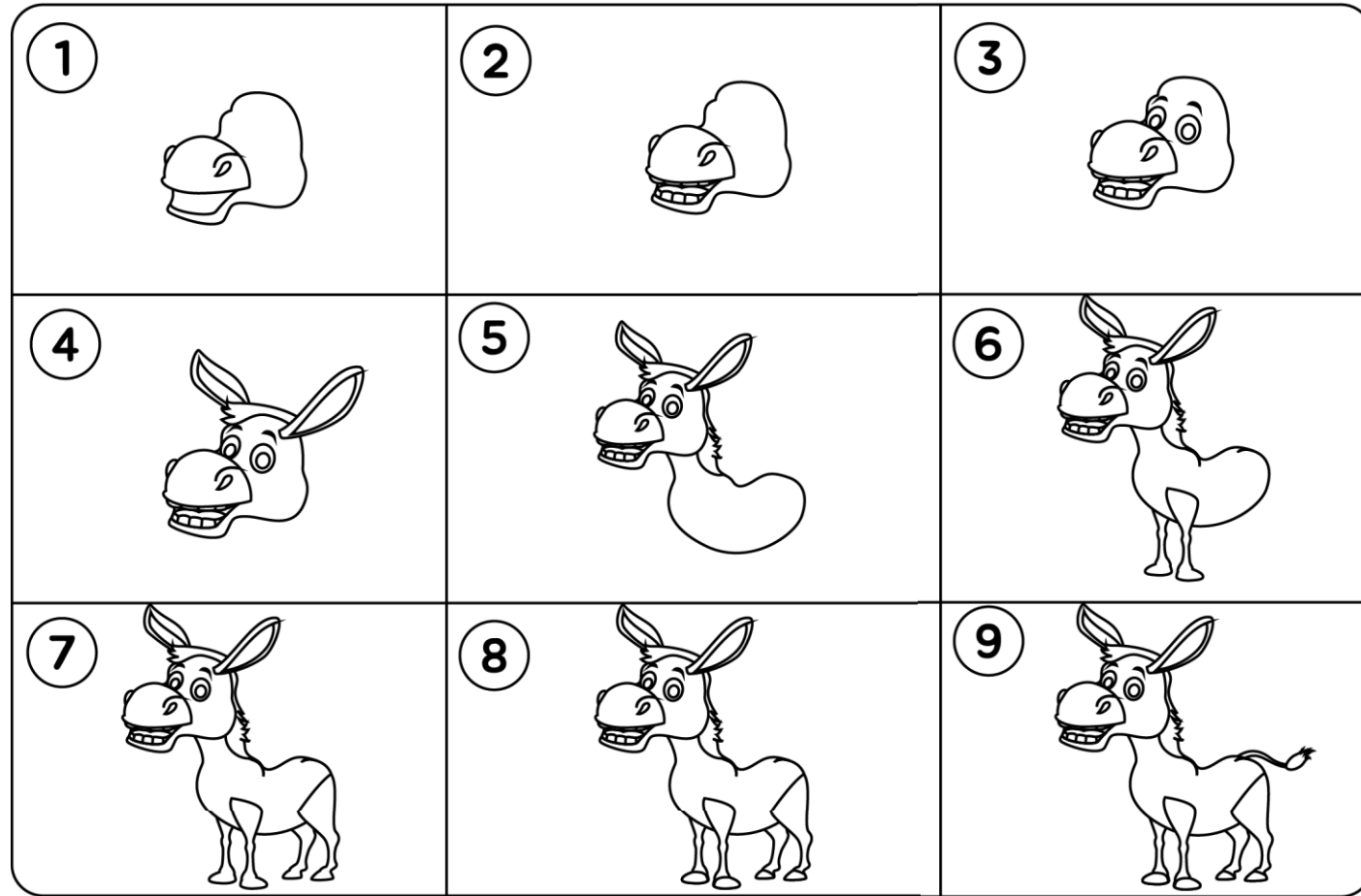

## Practice

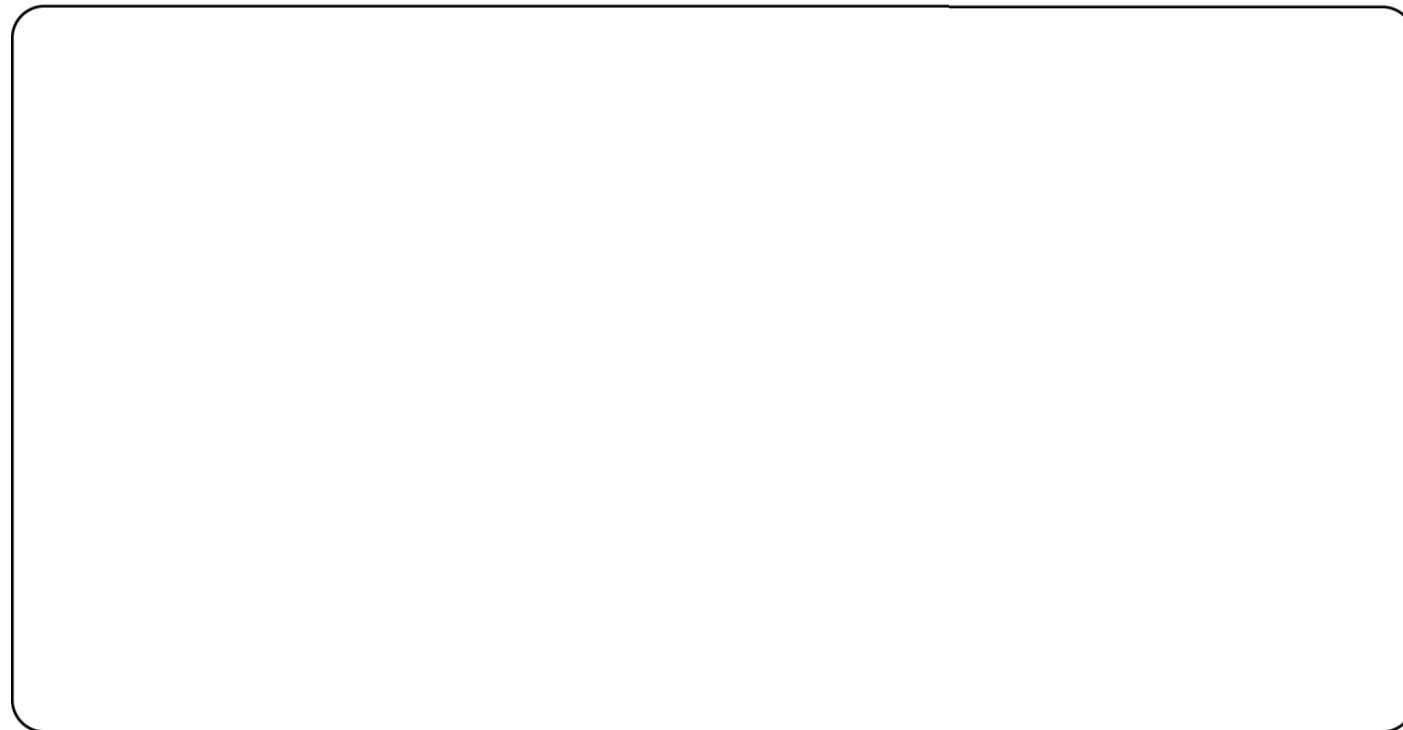

# Snowflake

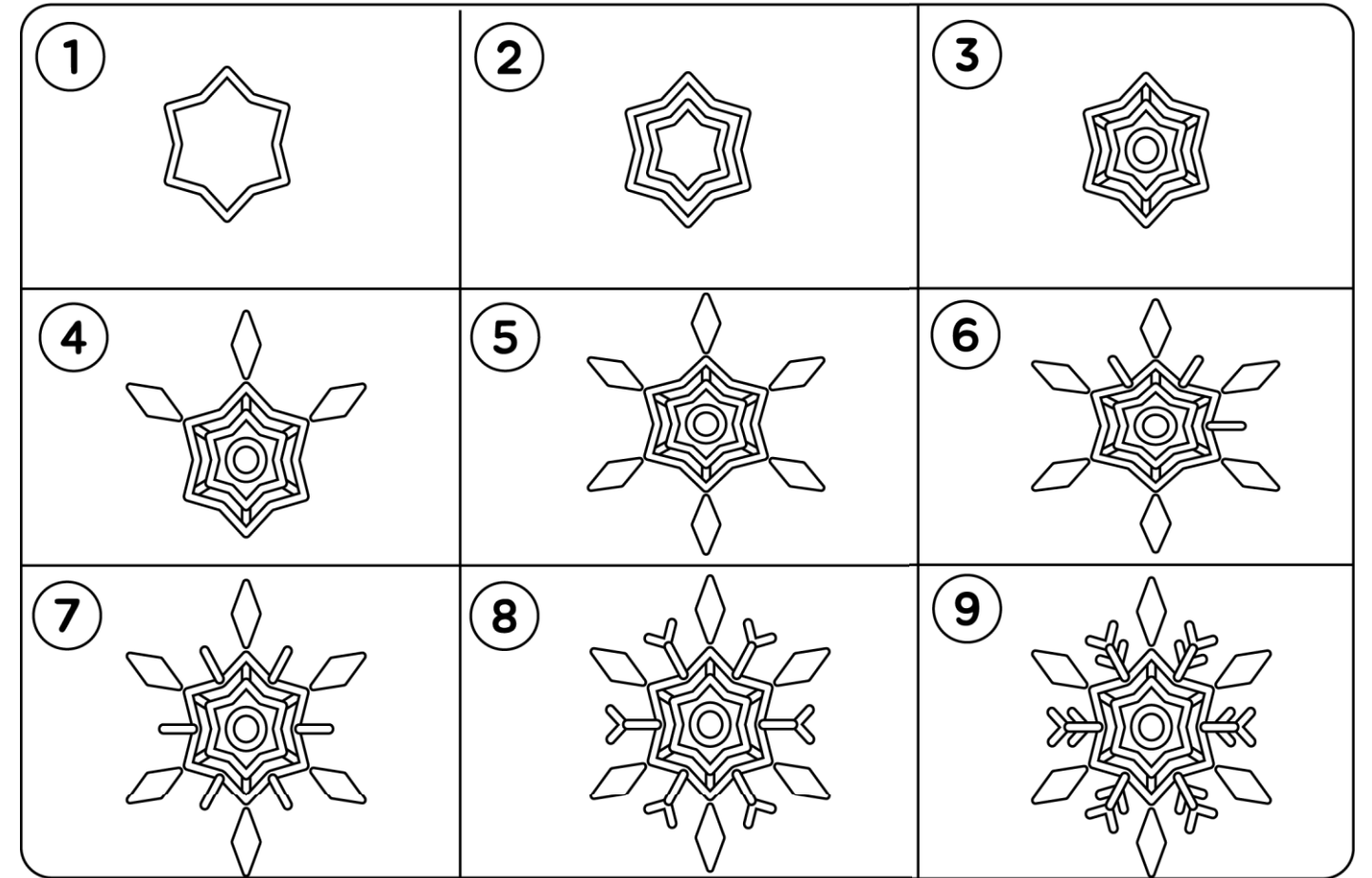

## Practice

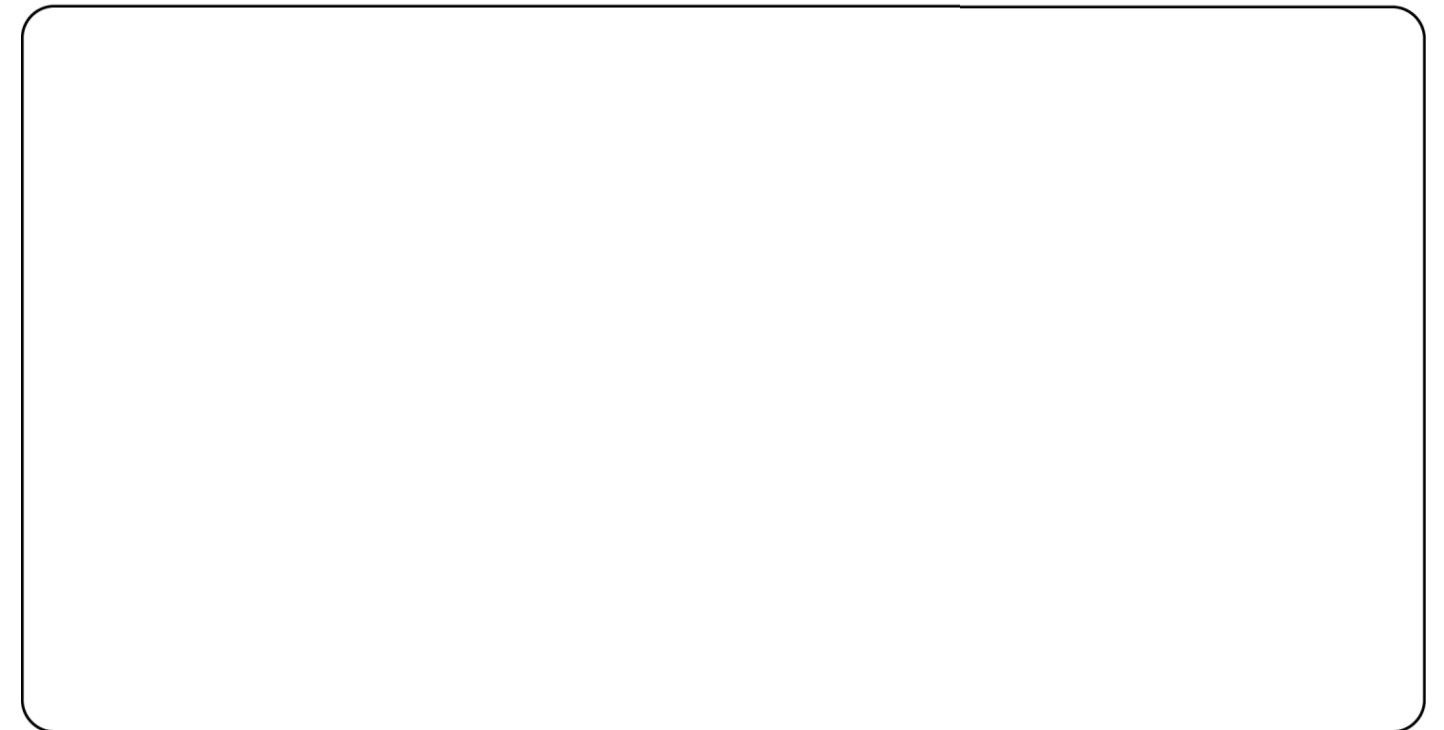

# Pterodactyl

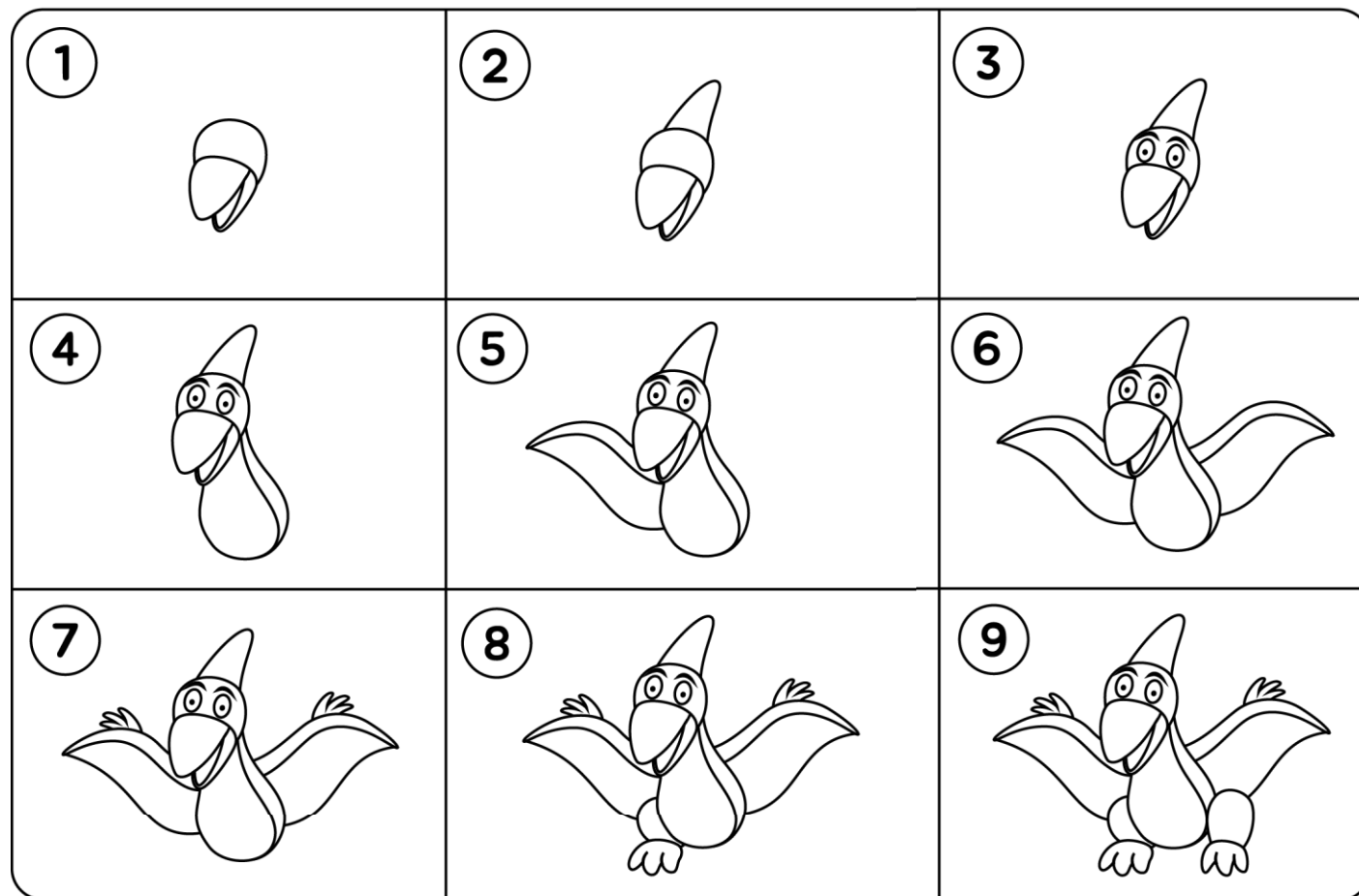

Practice



# Robot

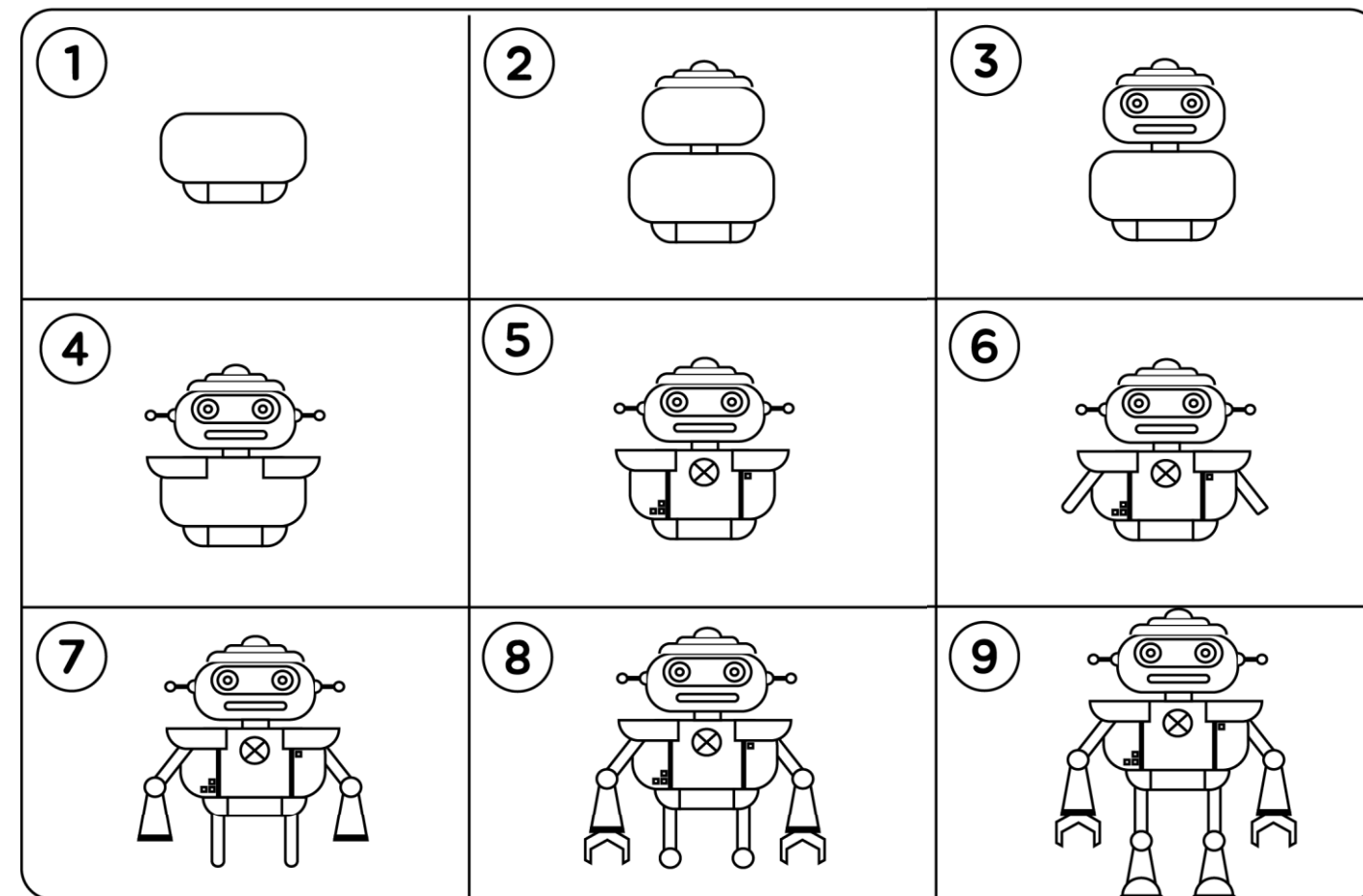

Practice



# Hippopotamus

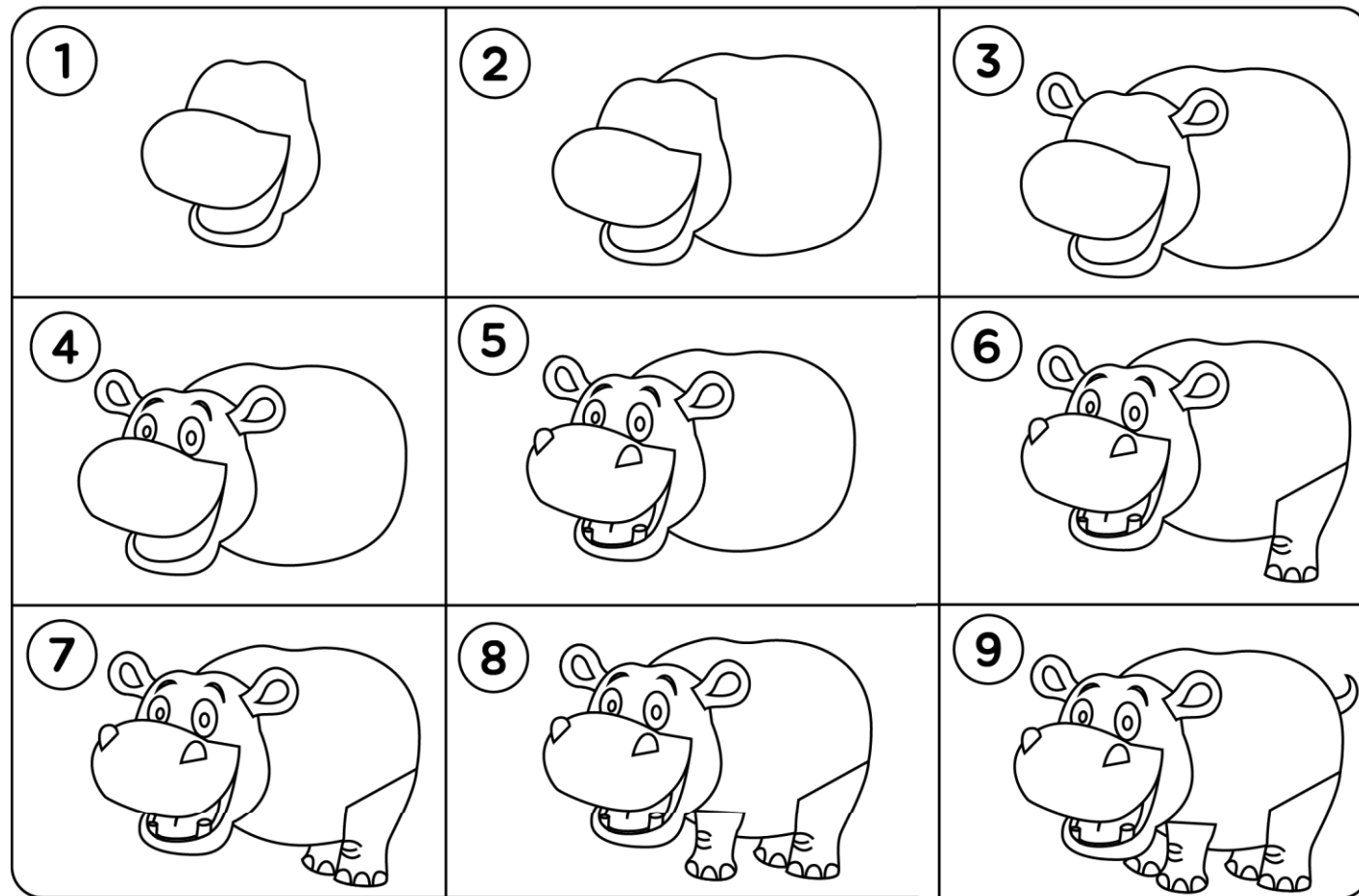

*Practice*

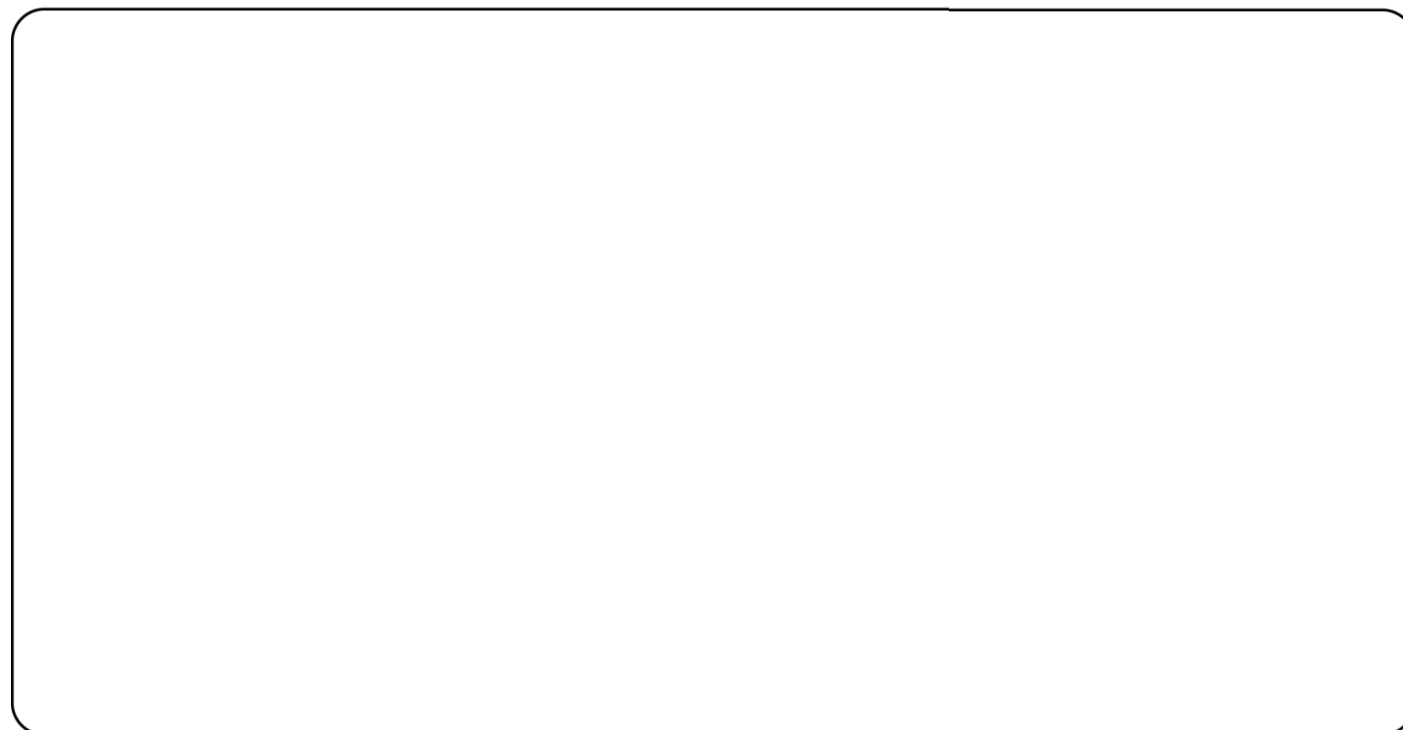

# Iguana

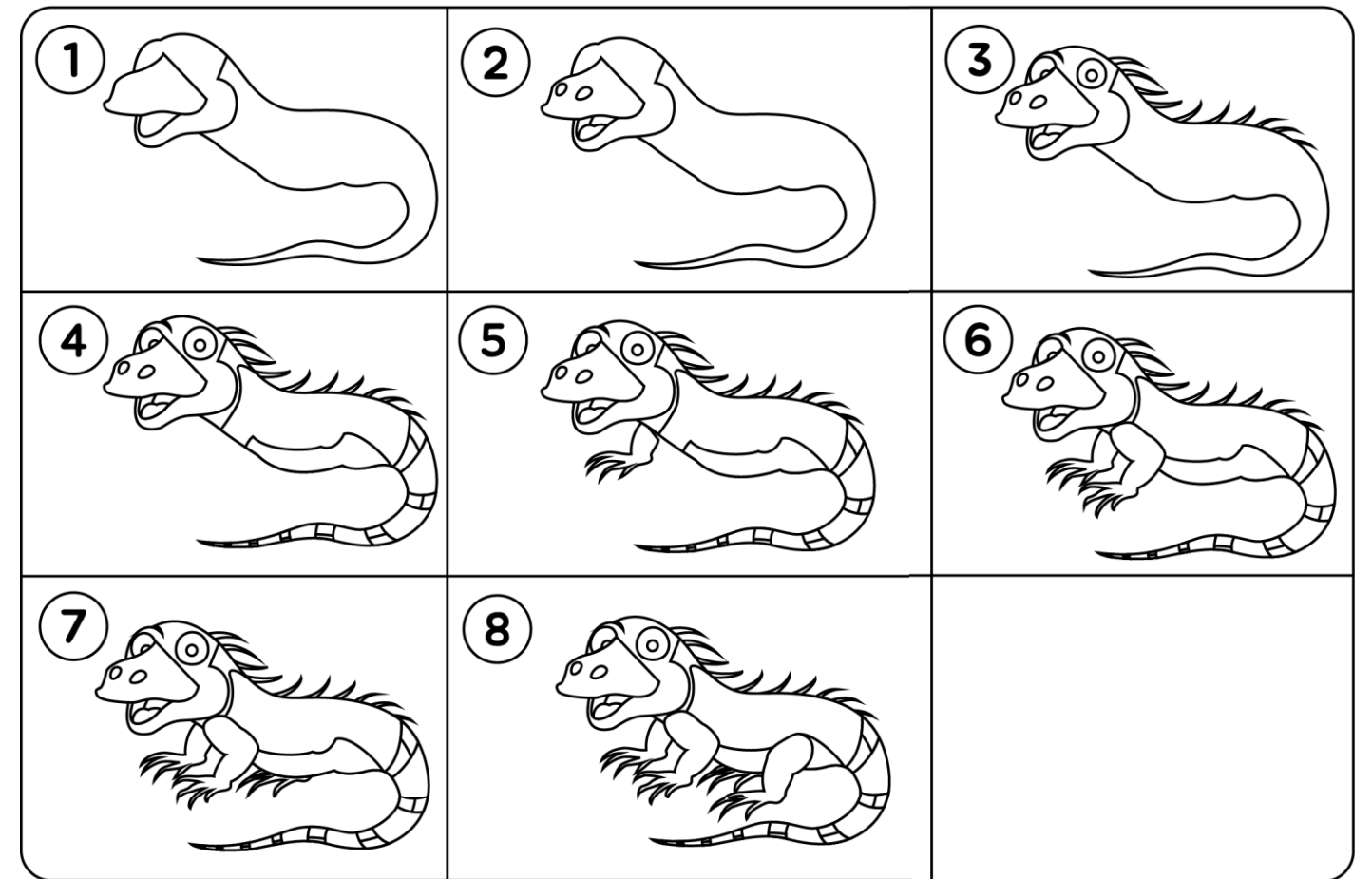

*Practice*

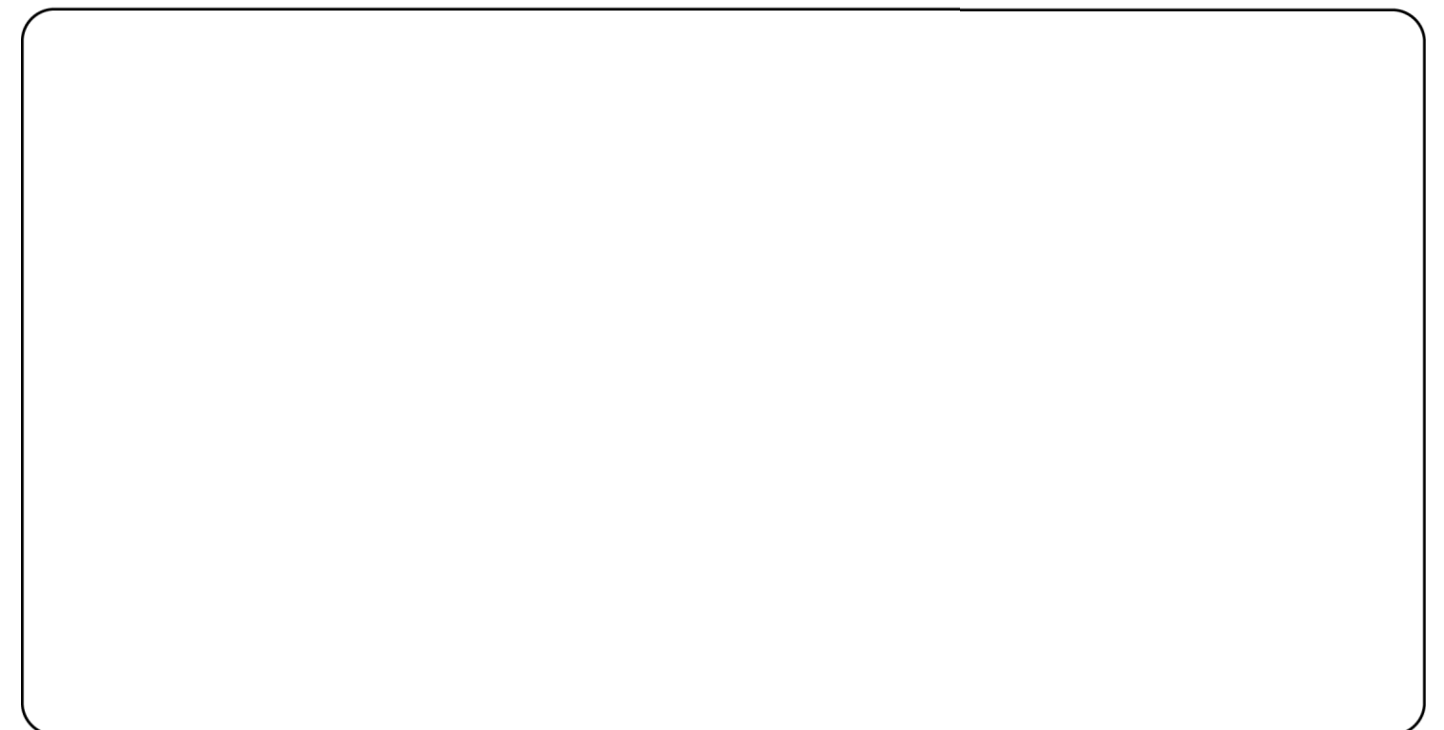

# Ladybug

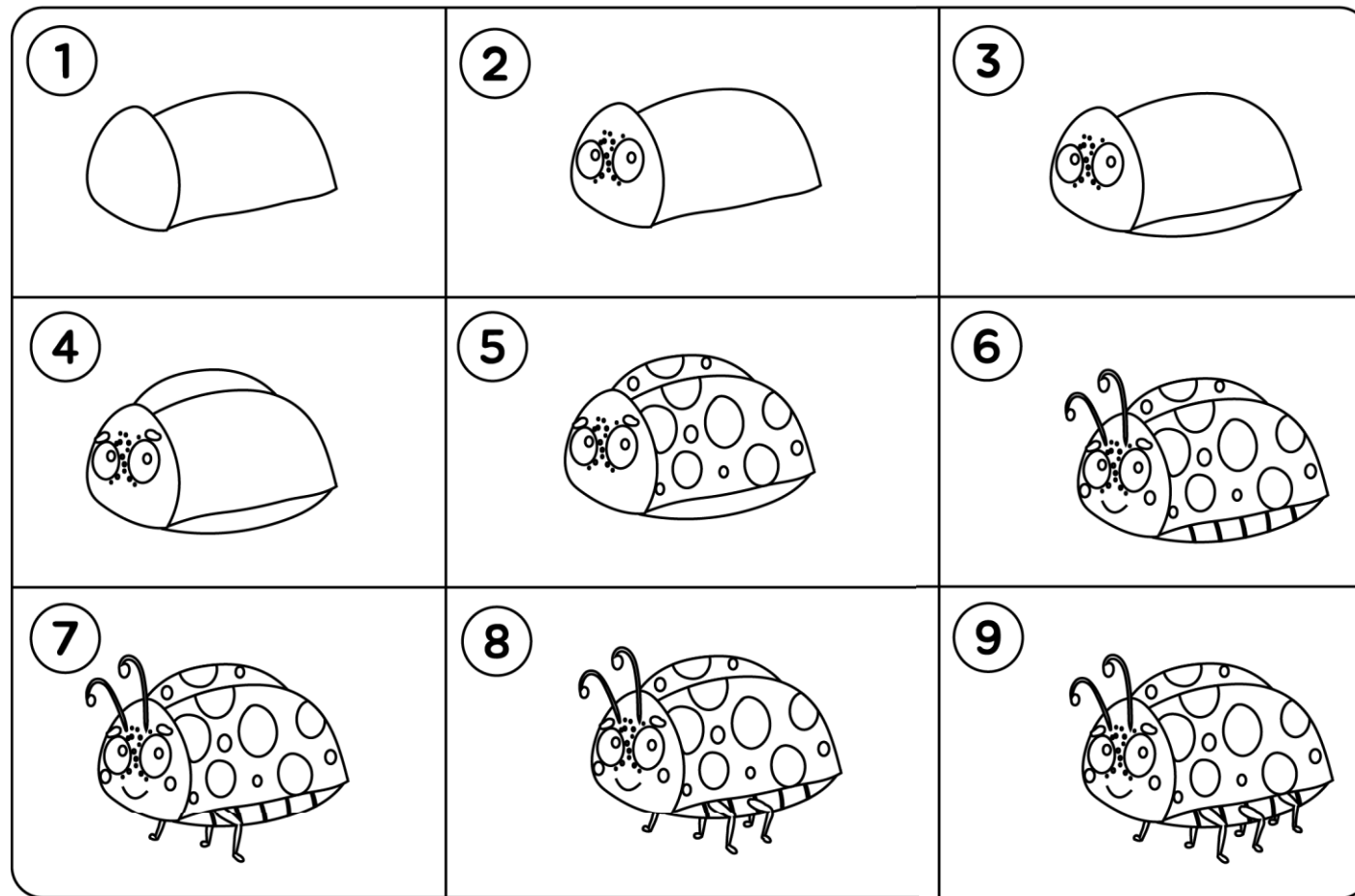

# Practice

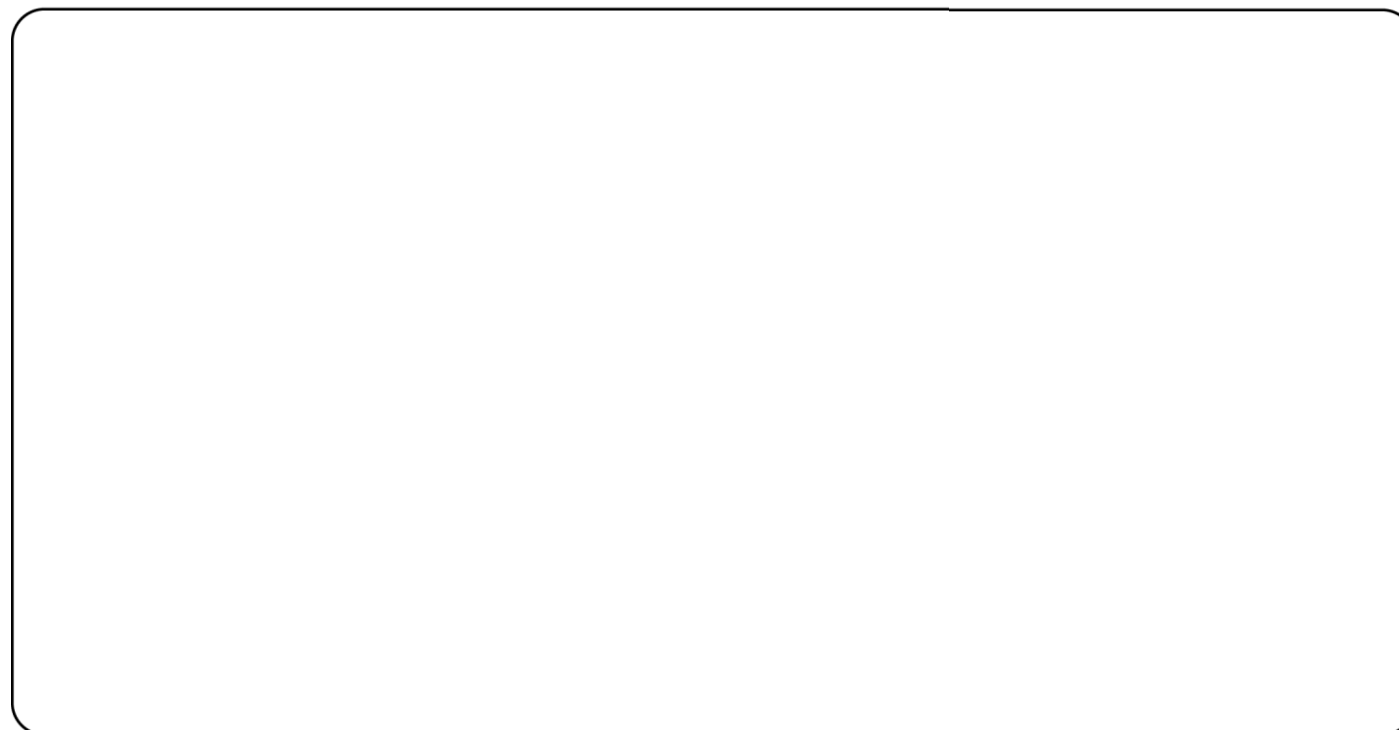

# Shark

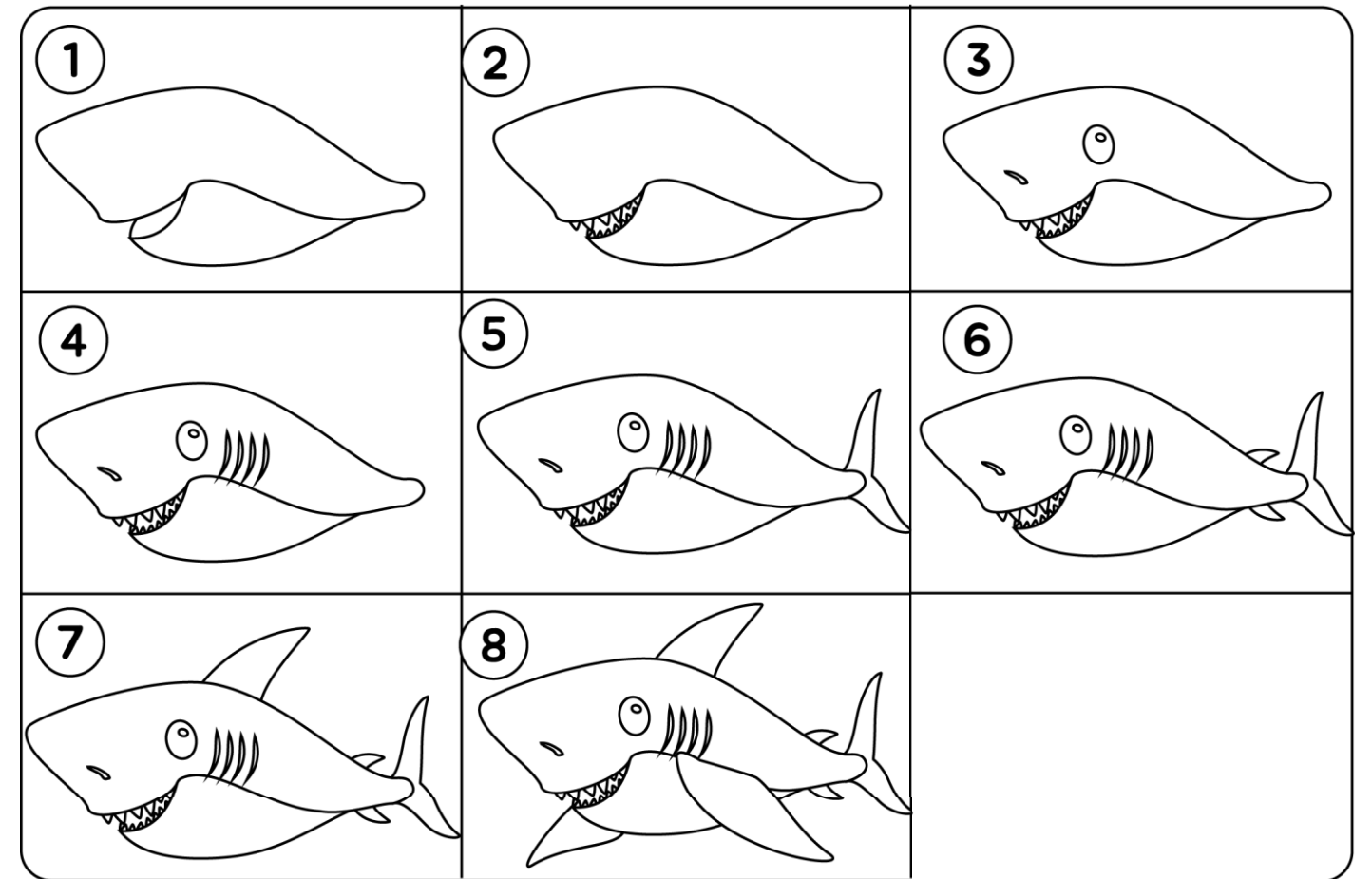

# Practice

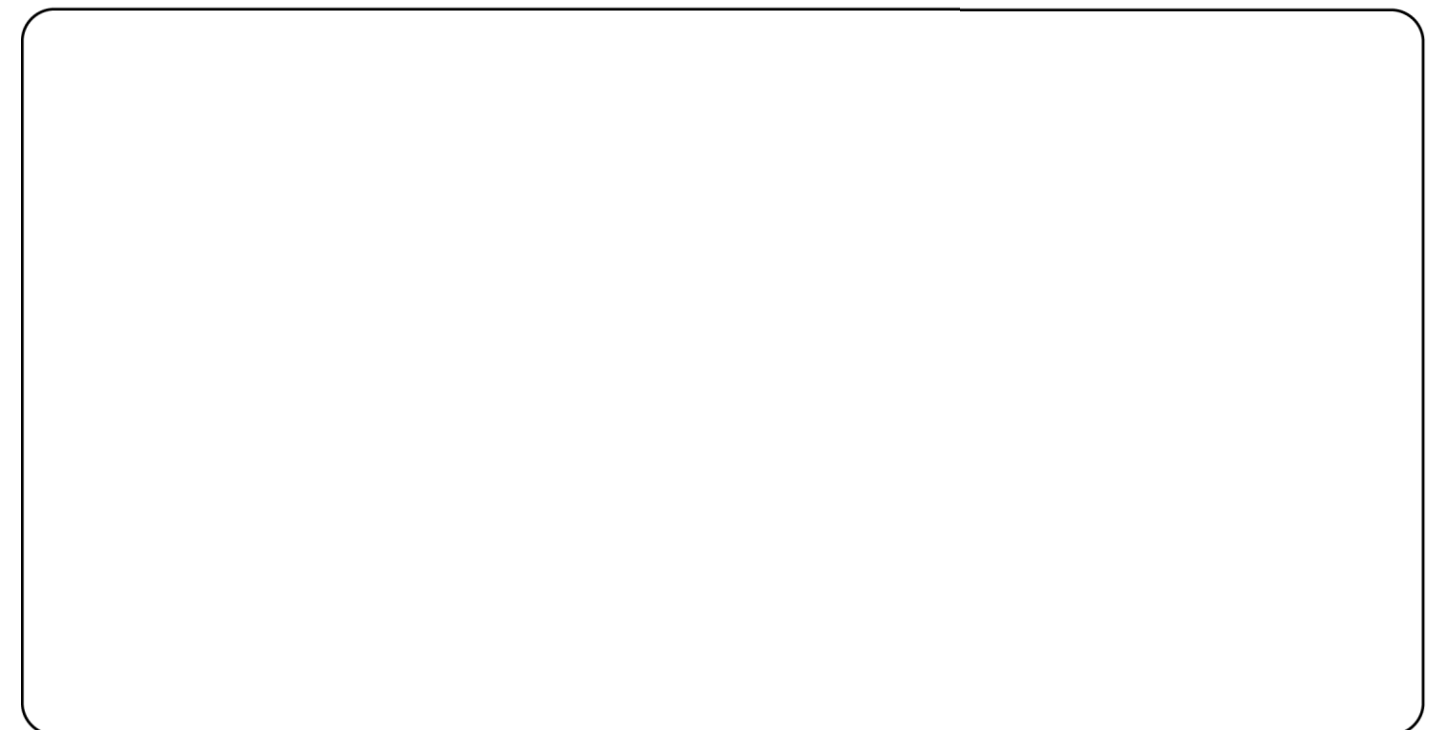

# Lobster

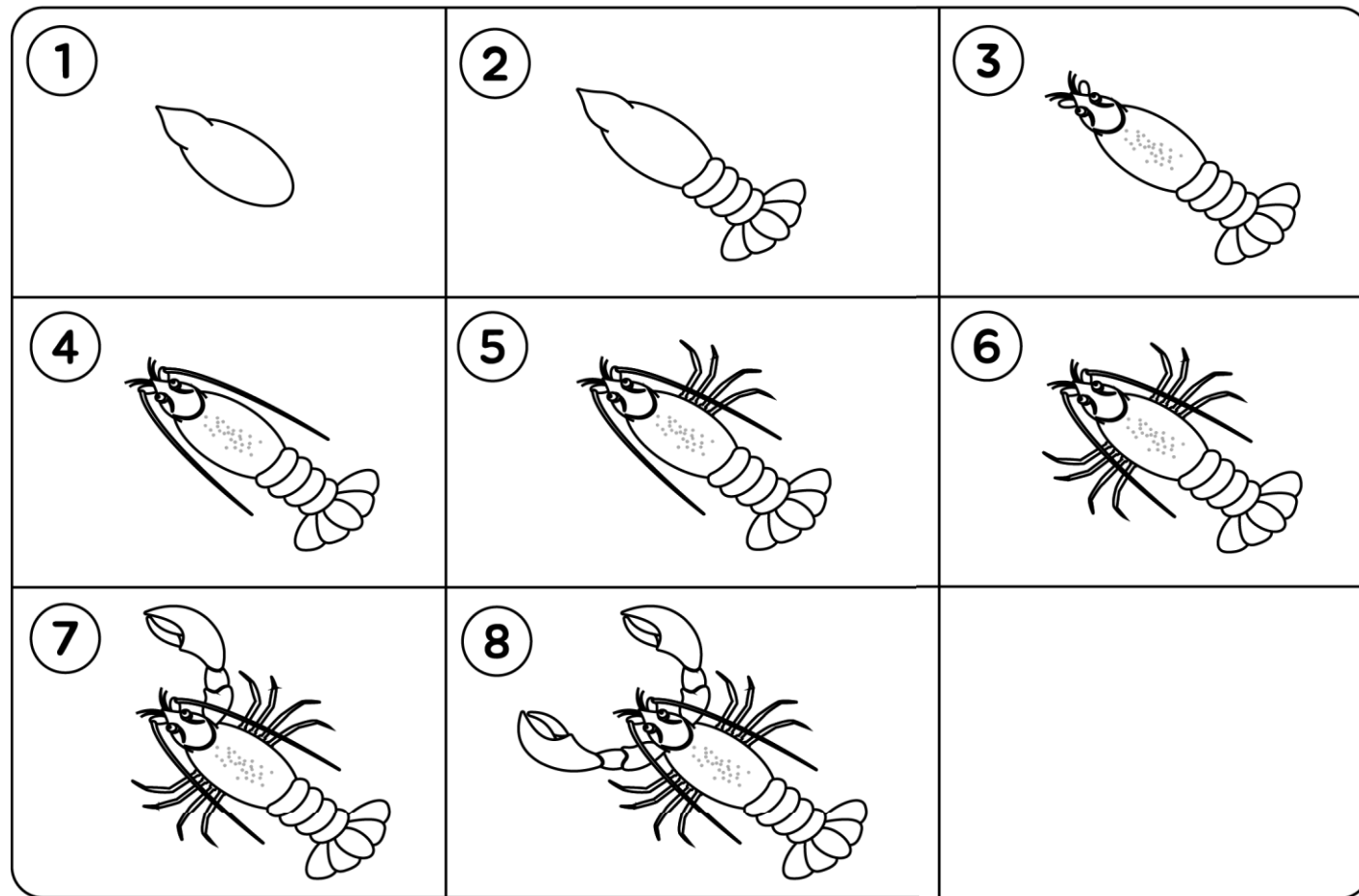

## Practice

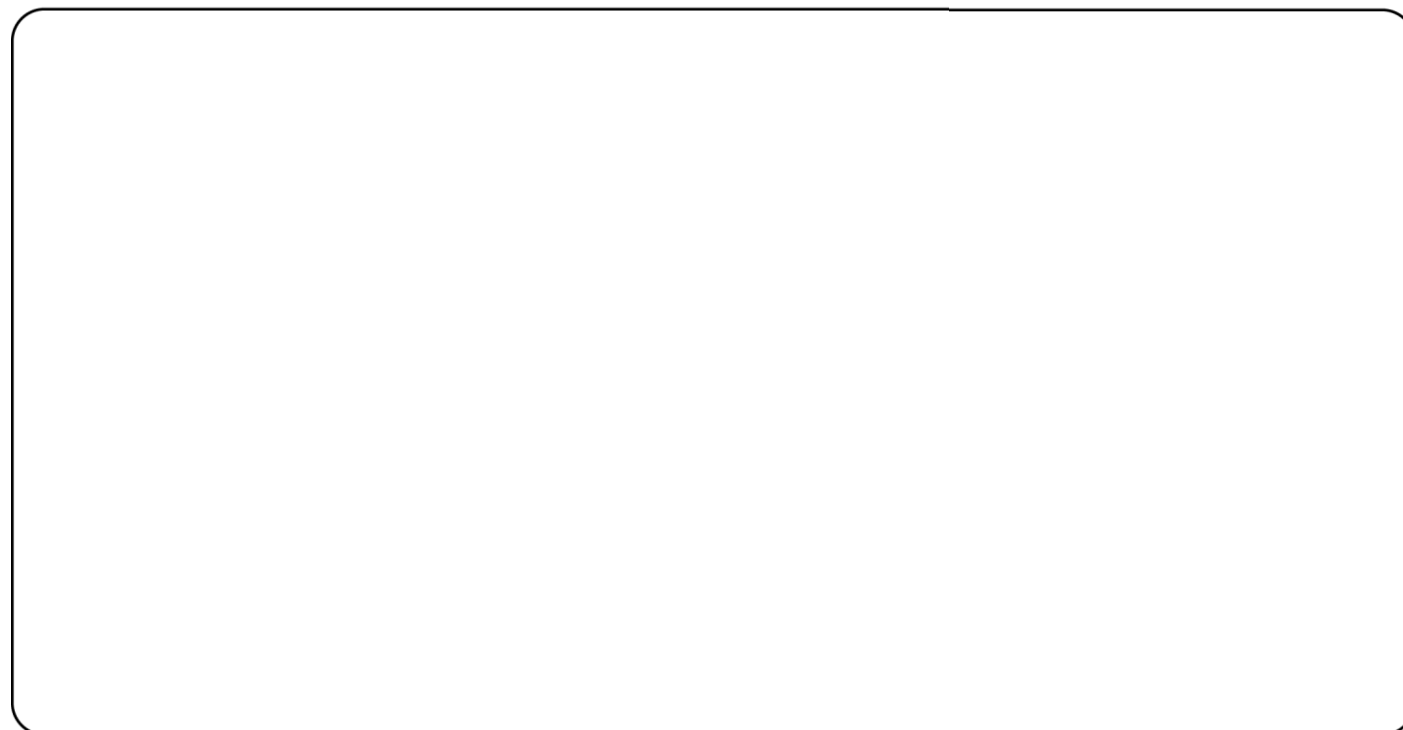

# Dragonfly

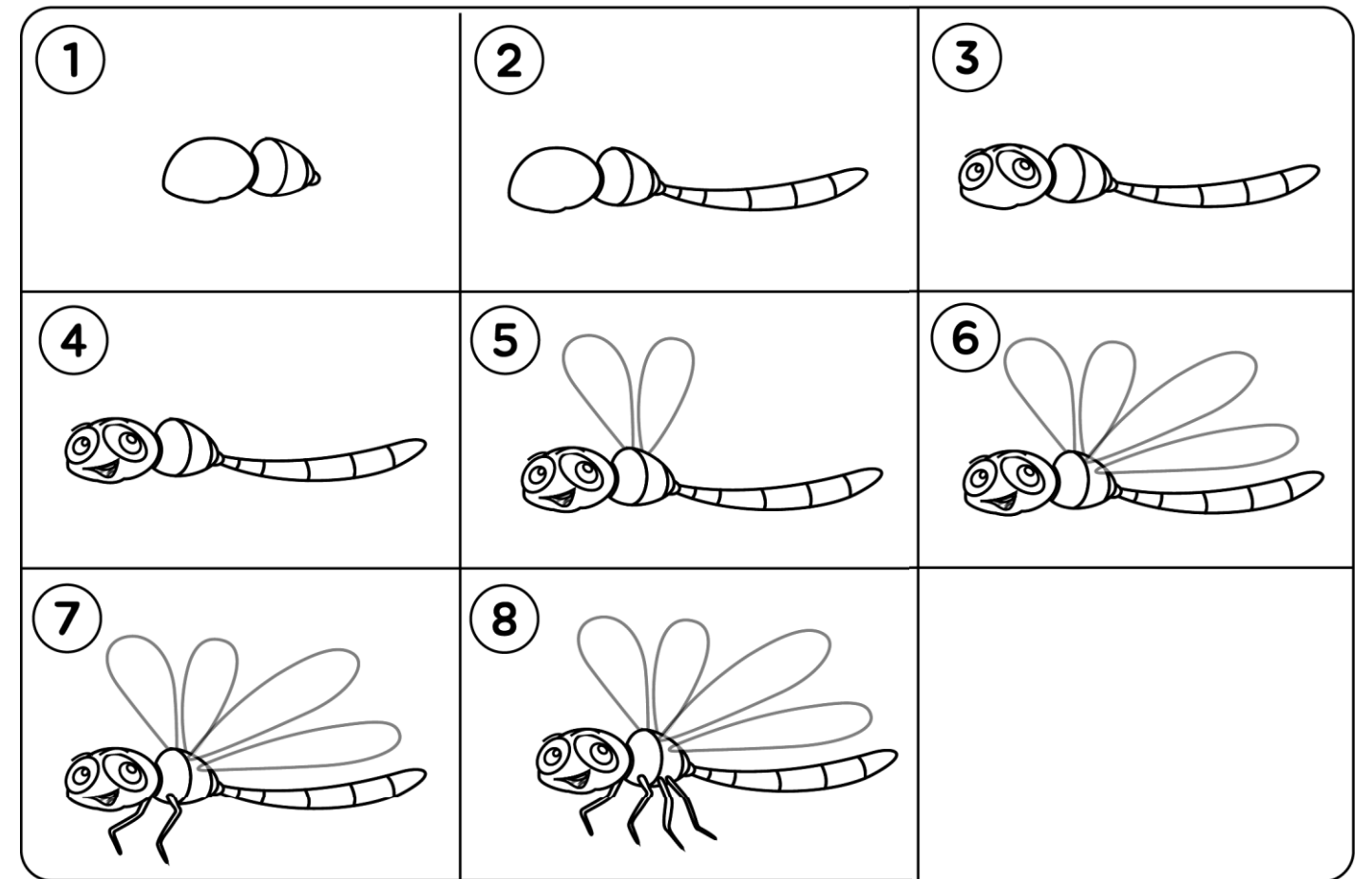

## Practice

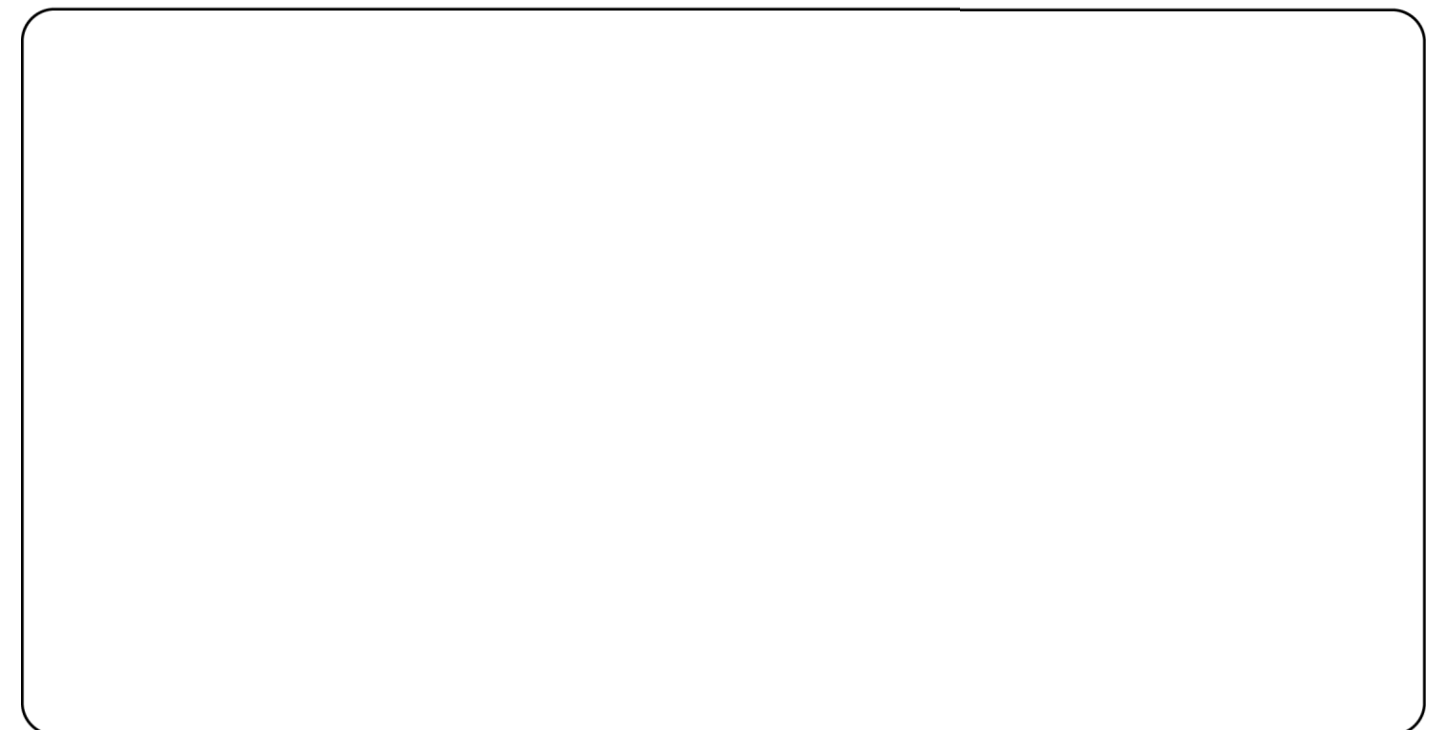

# Snake

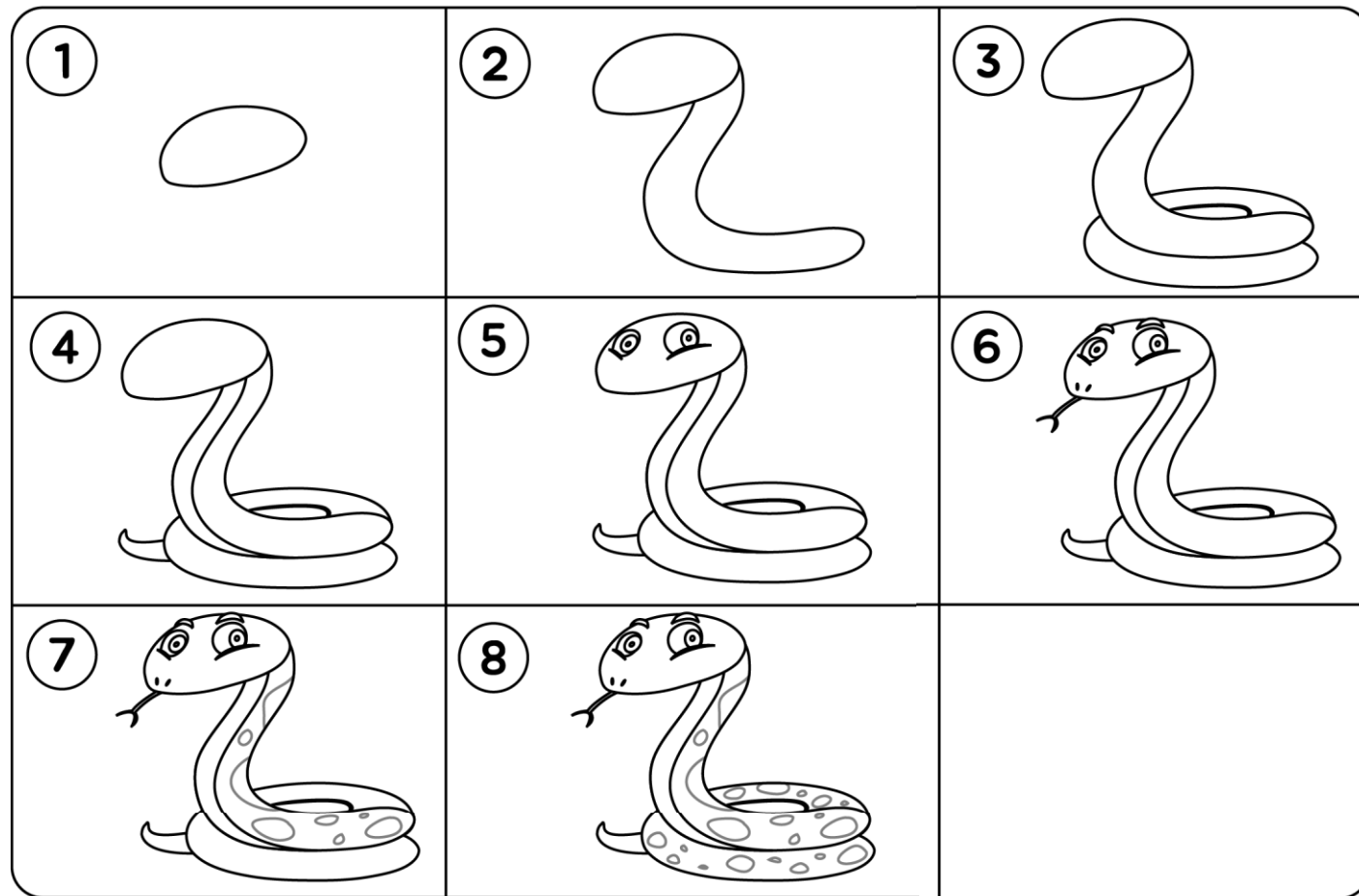

## Practice

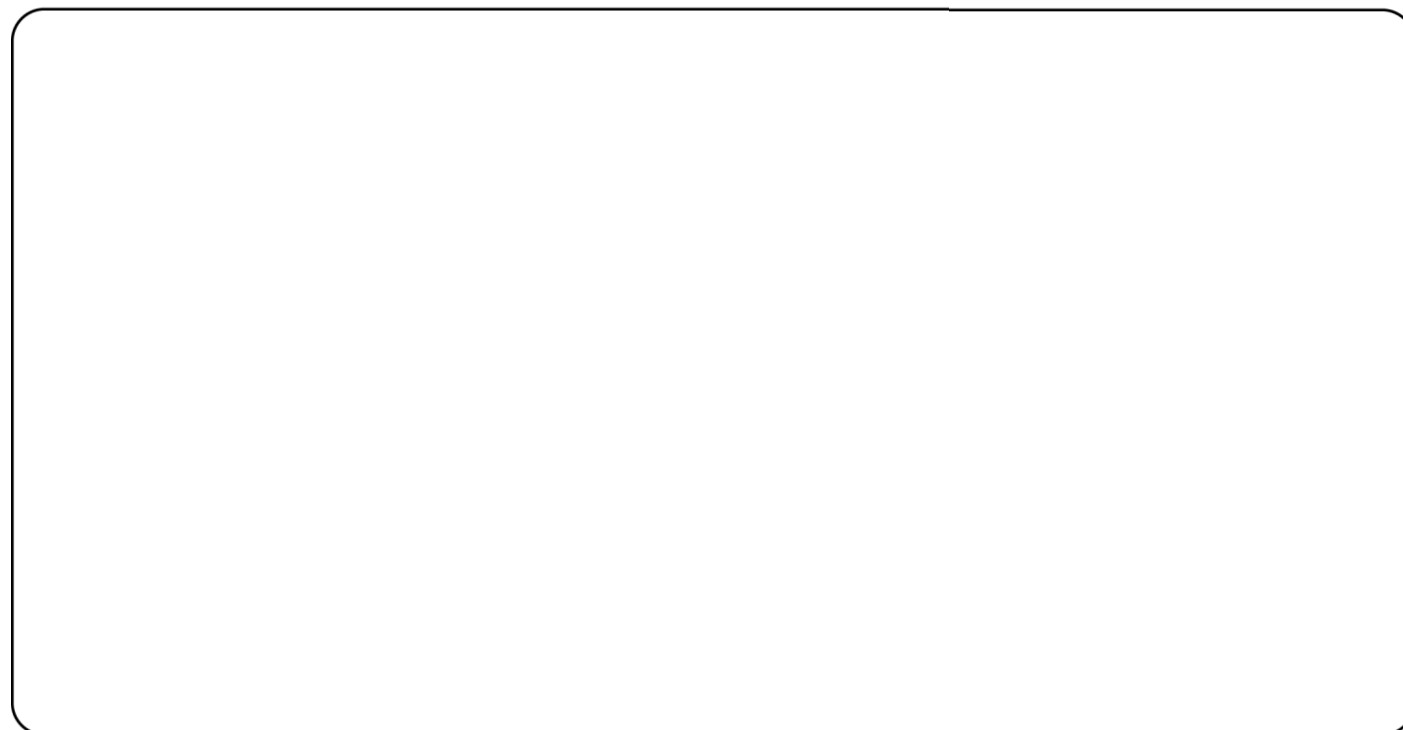

# Boy

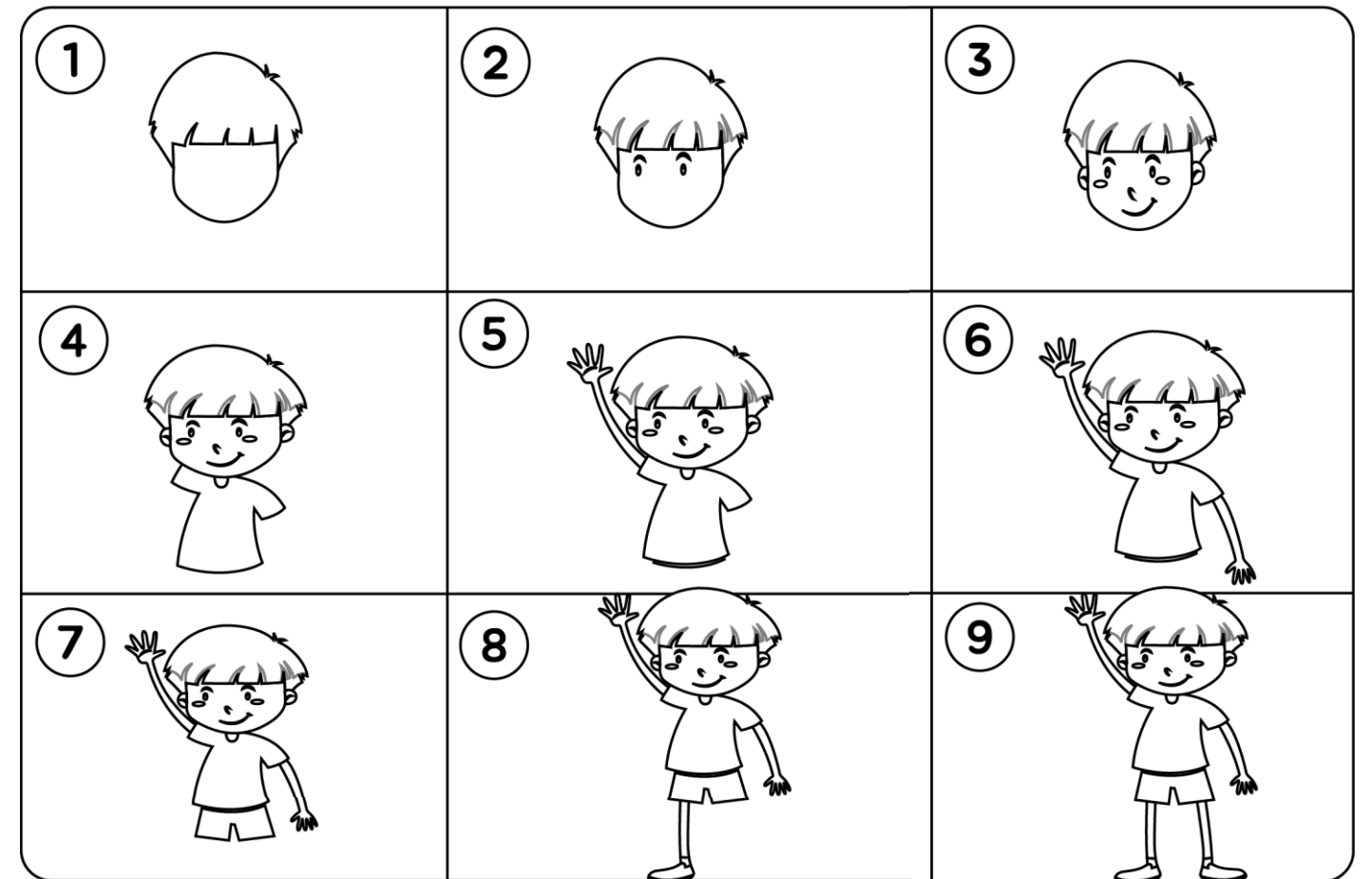

## Practice

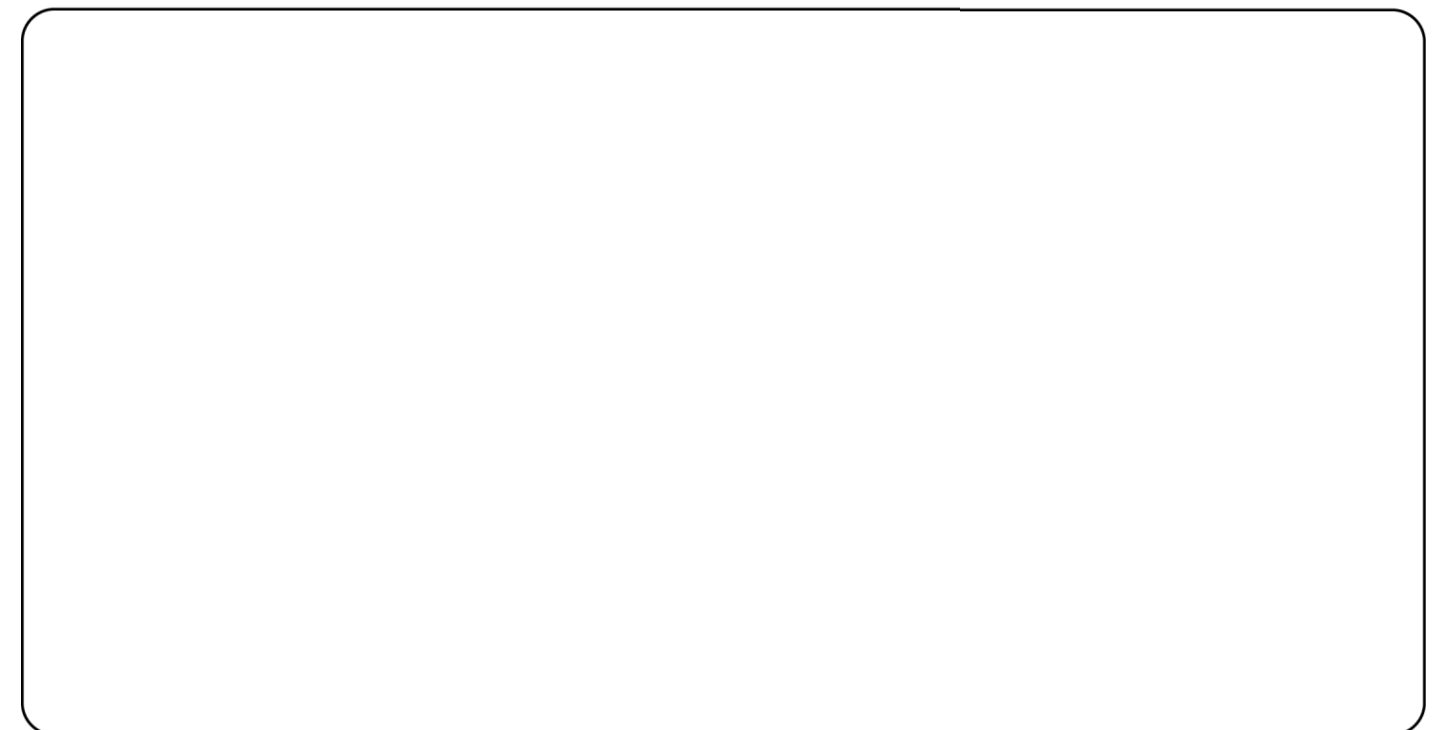

# Manta Ray

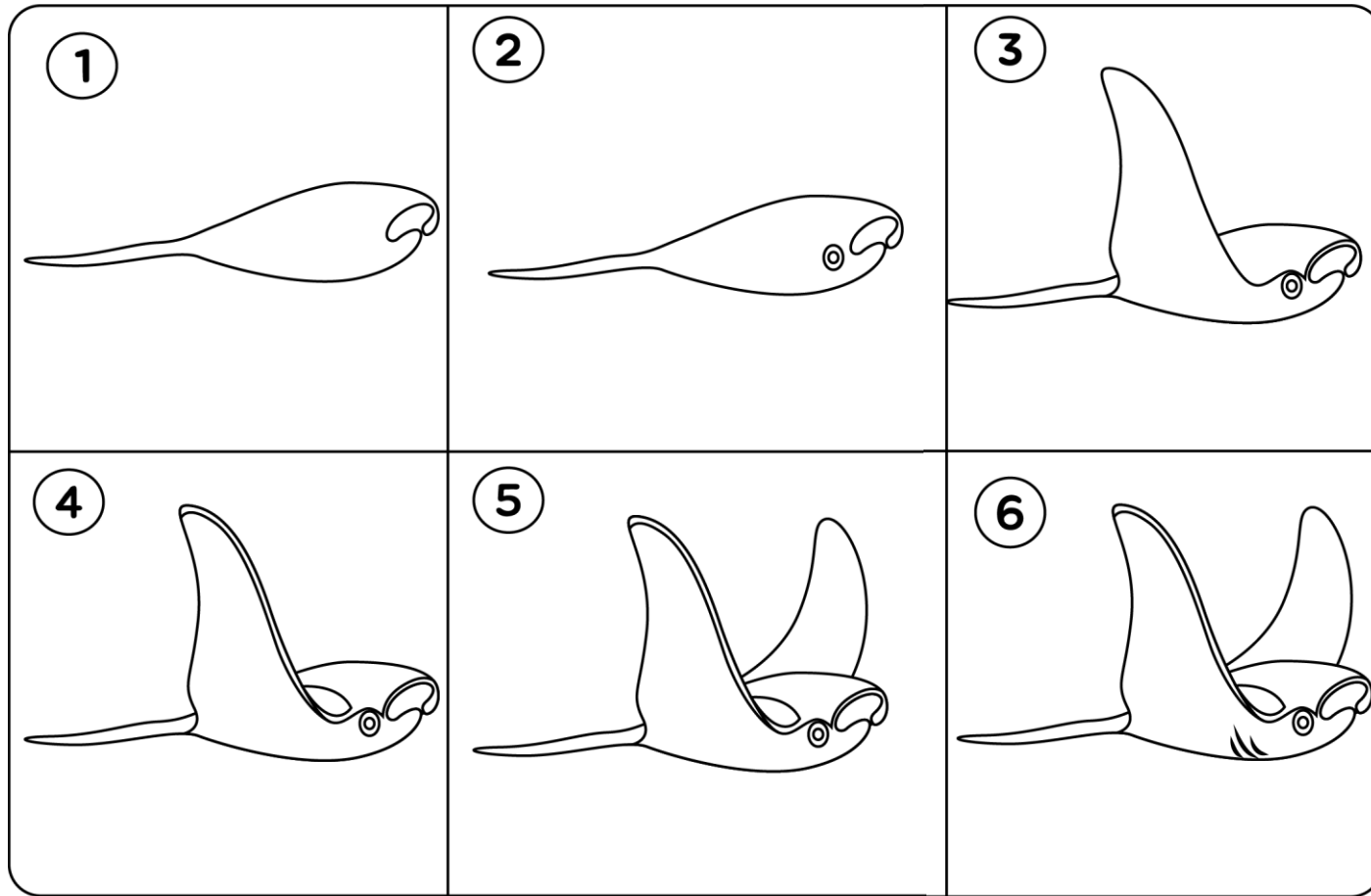

## Practice

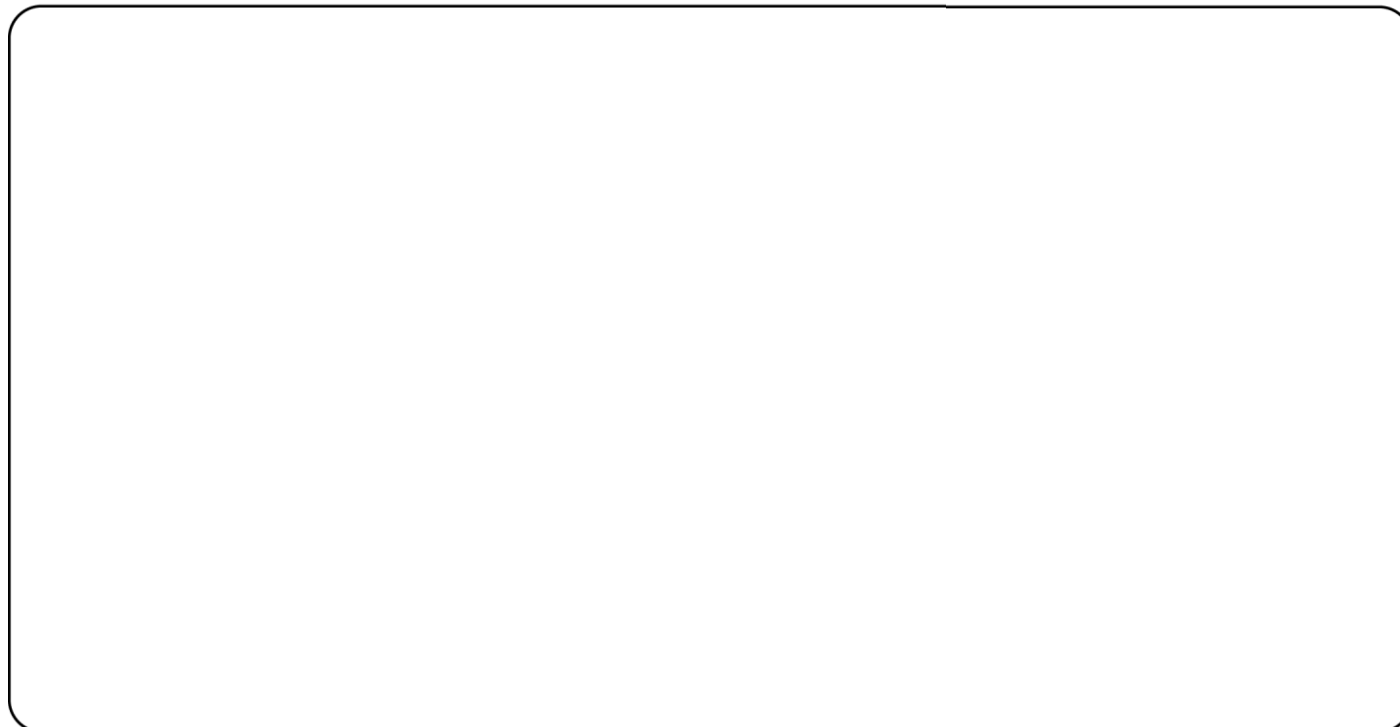

# Skeleton

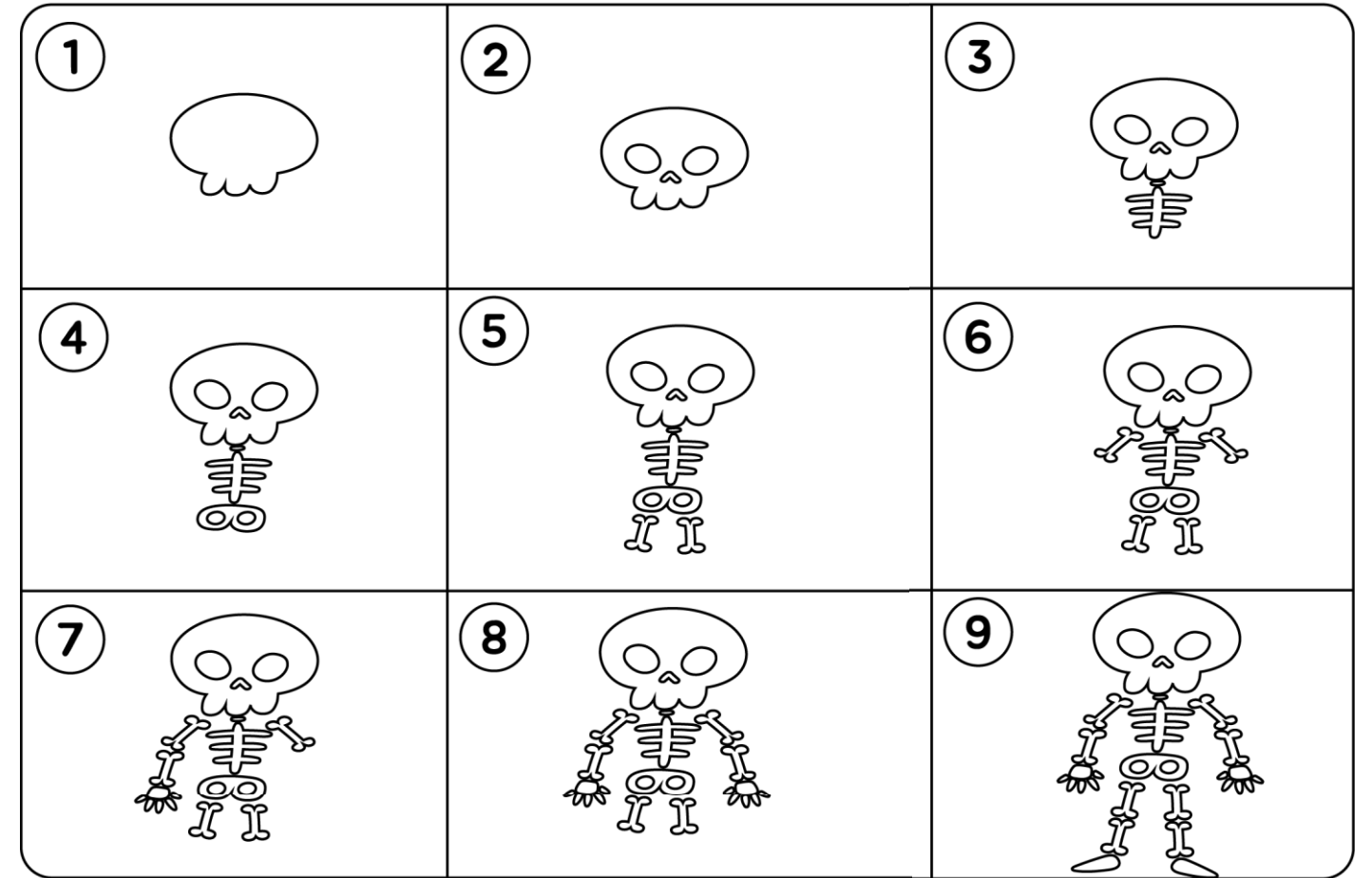

## Practice

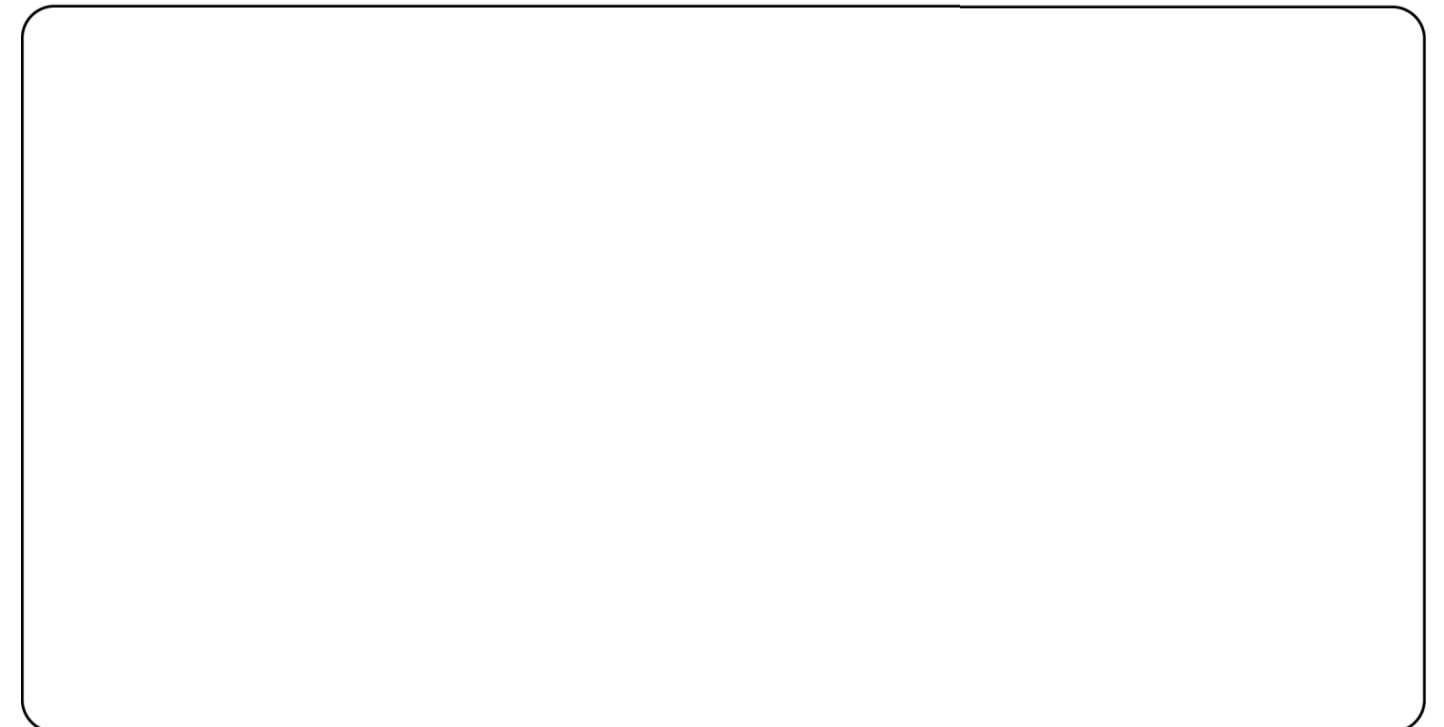

# Ostrich

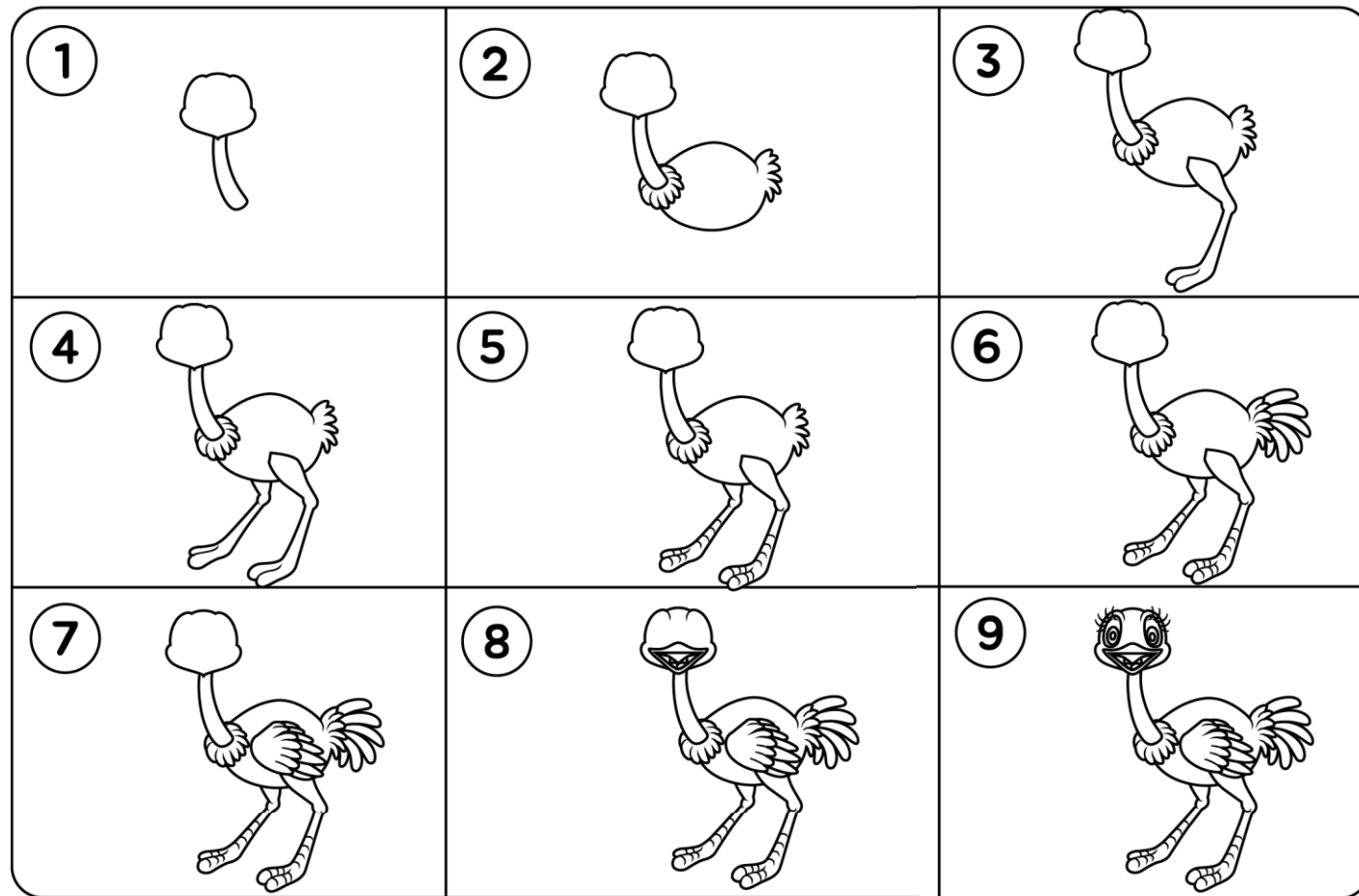

## Practice

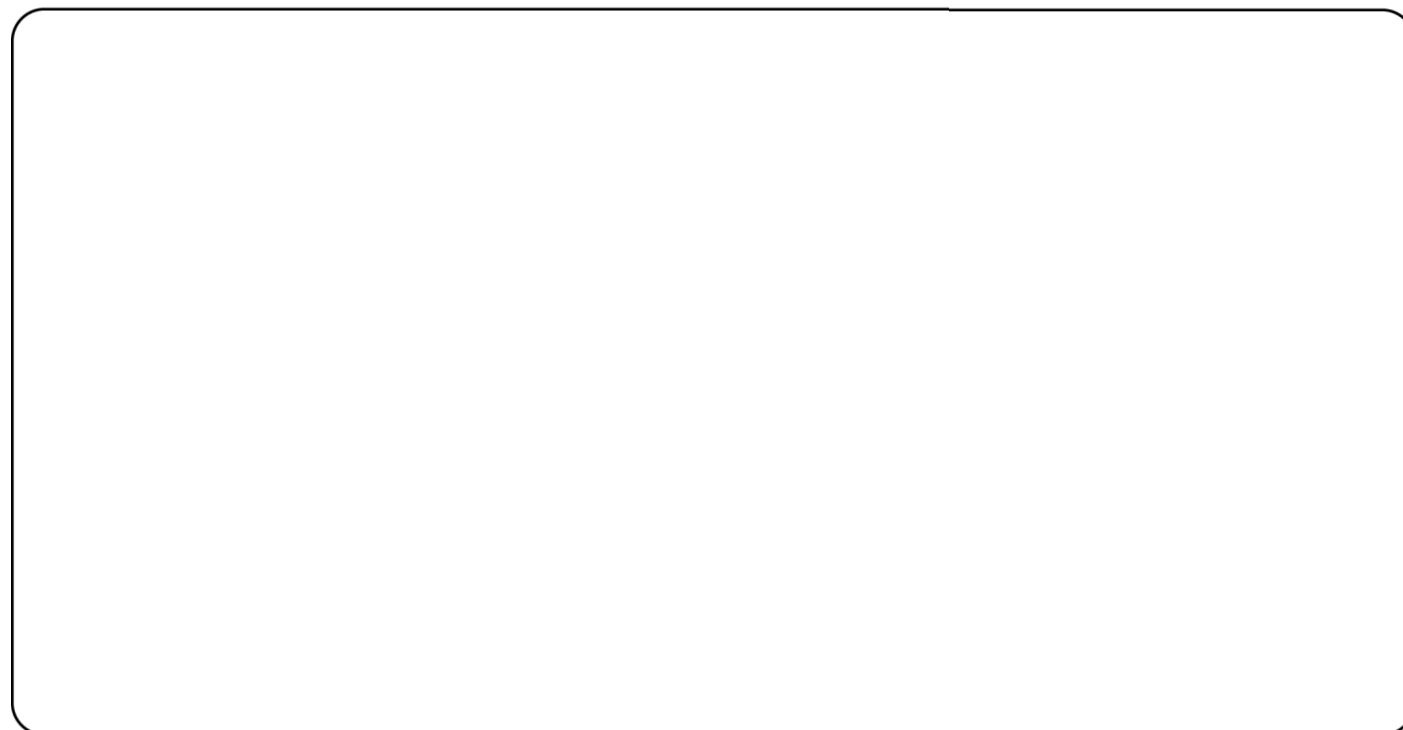

# Motorcycle

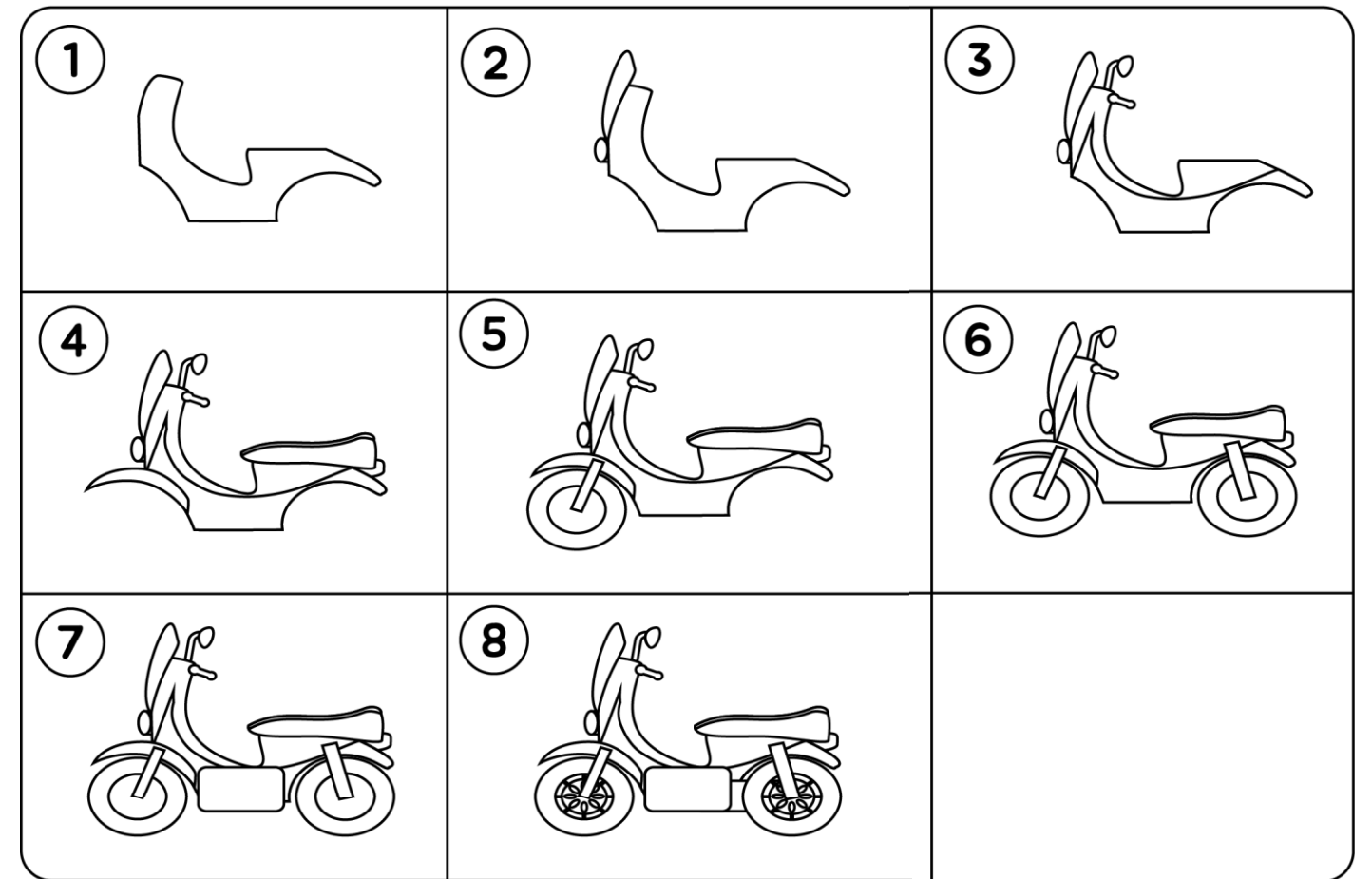

## Practice

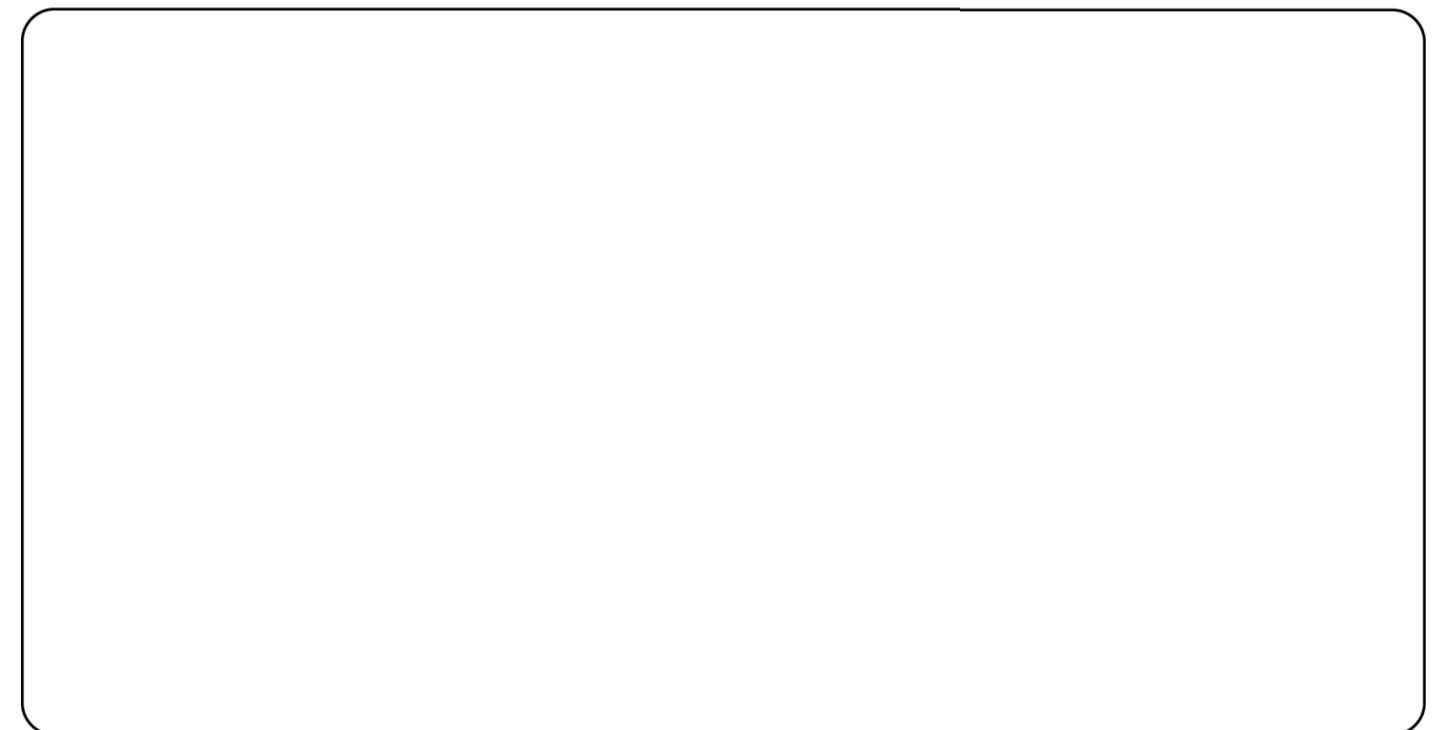

# Parrot

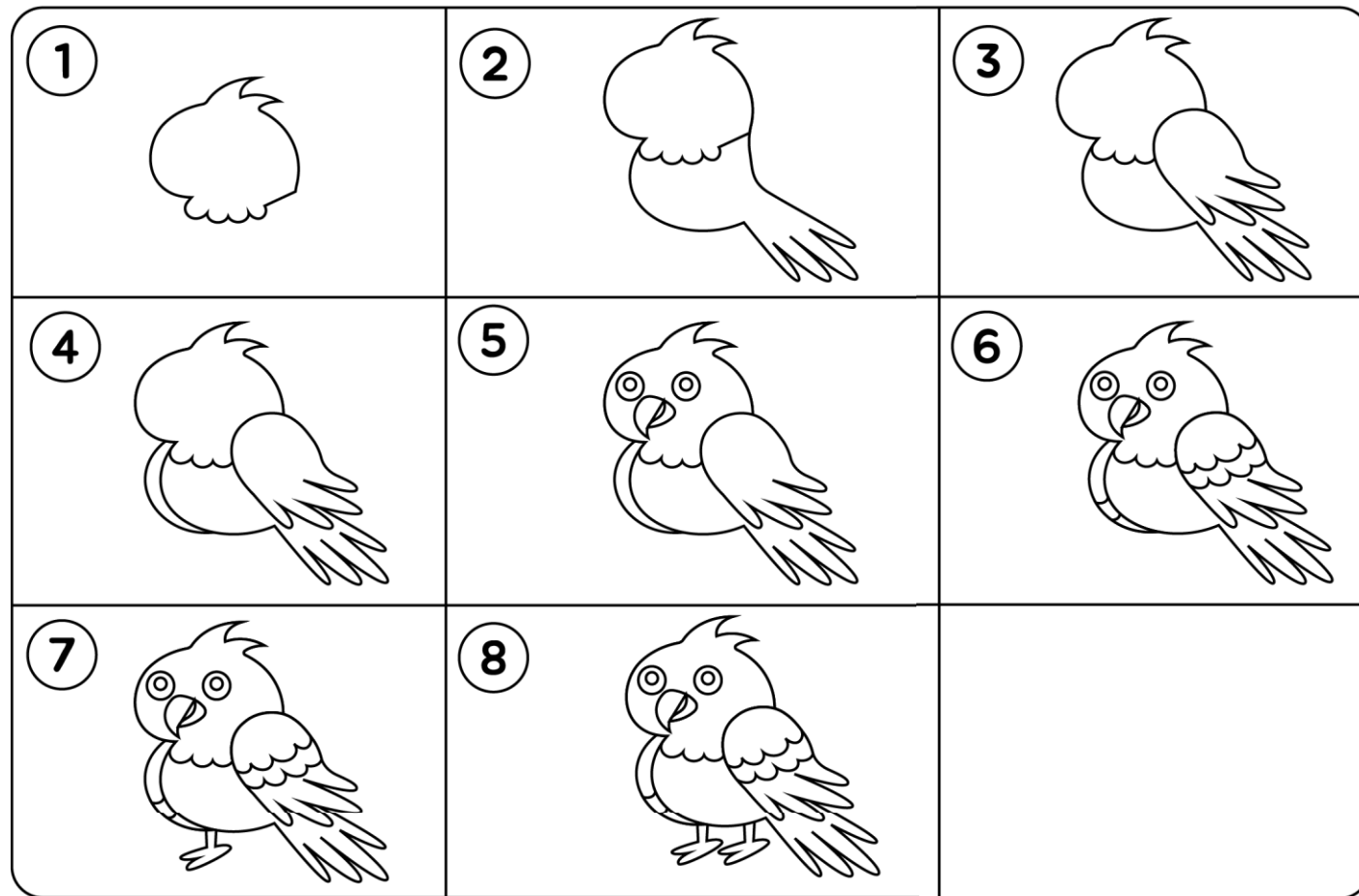

# Practice

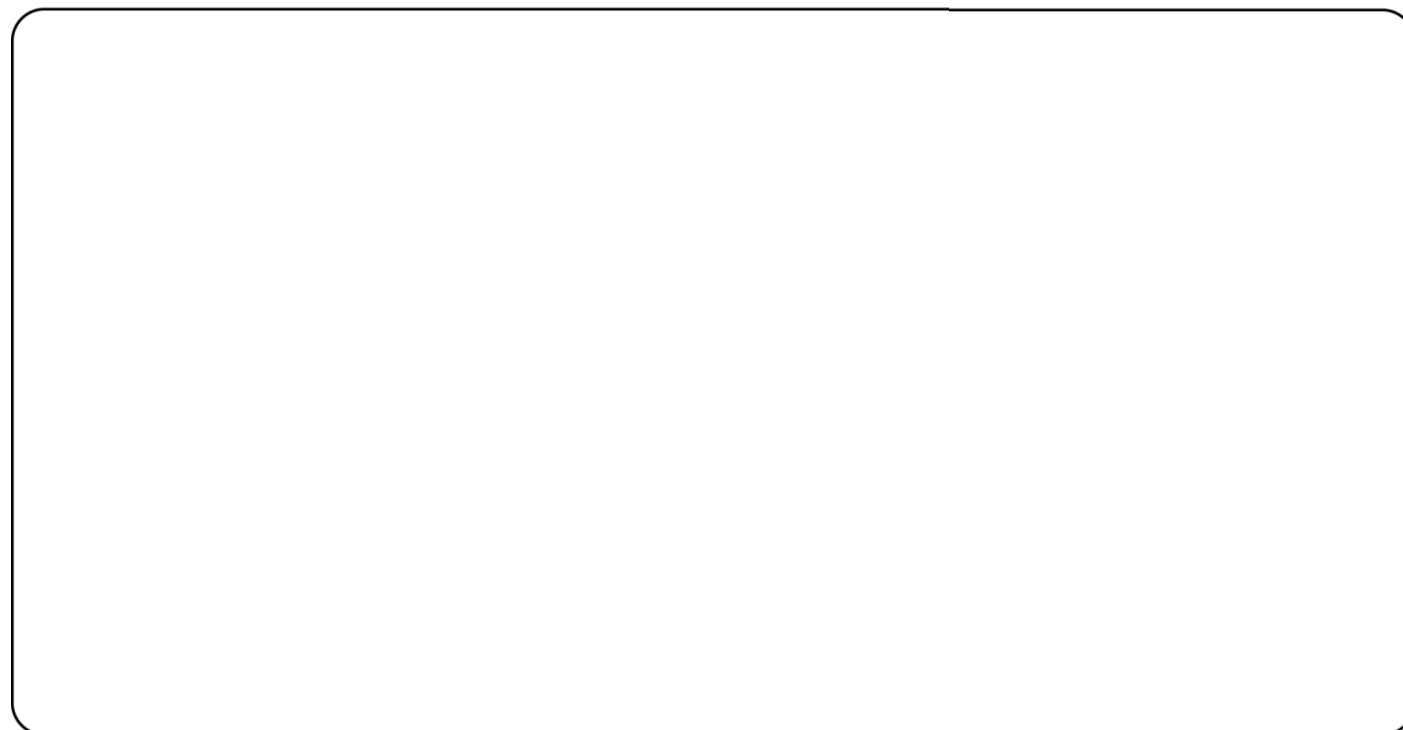

# Bat

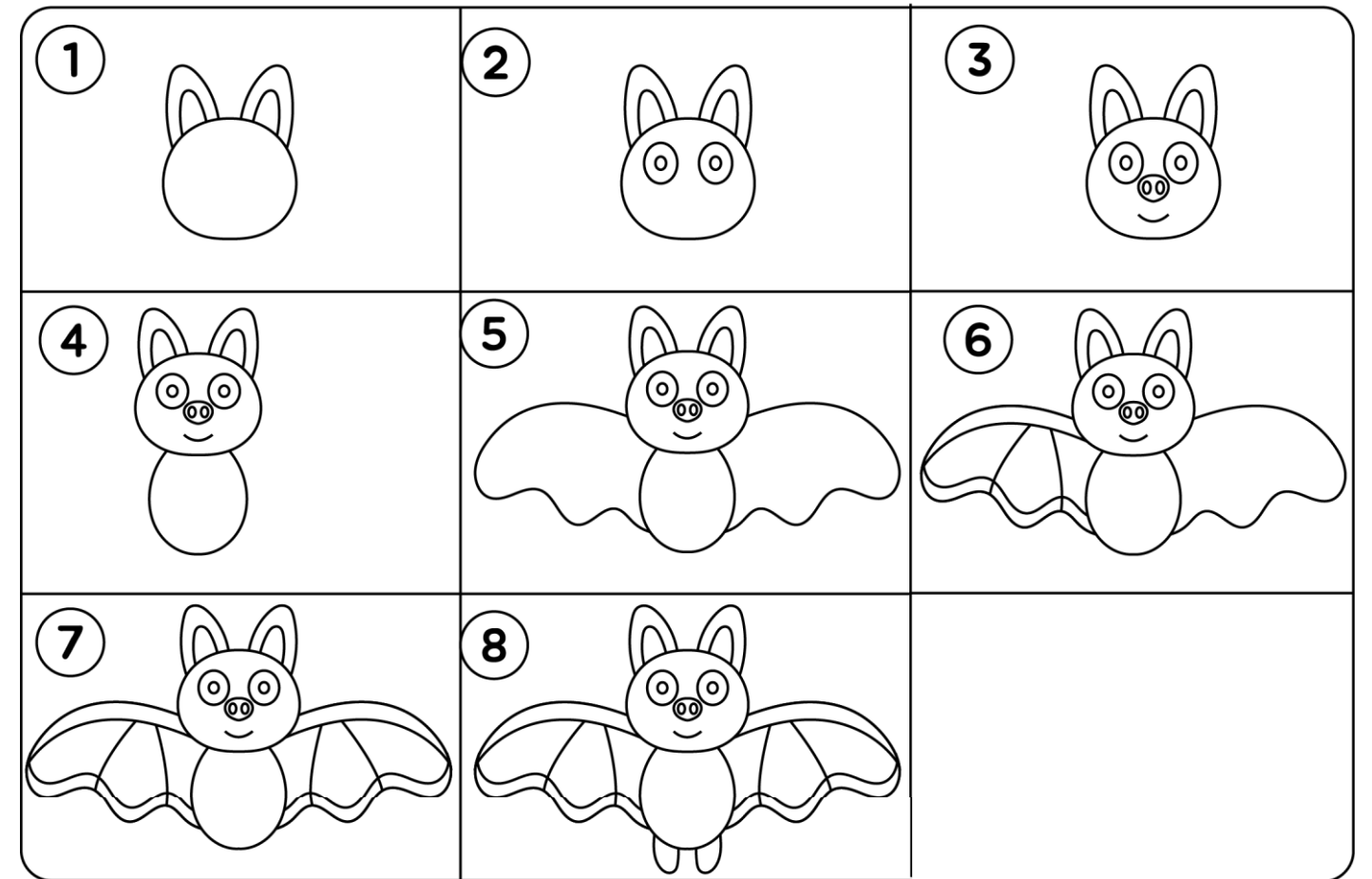

# Practice

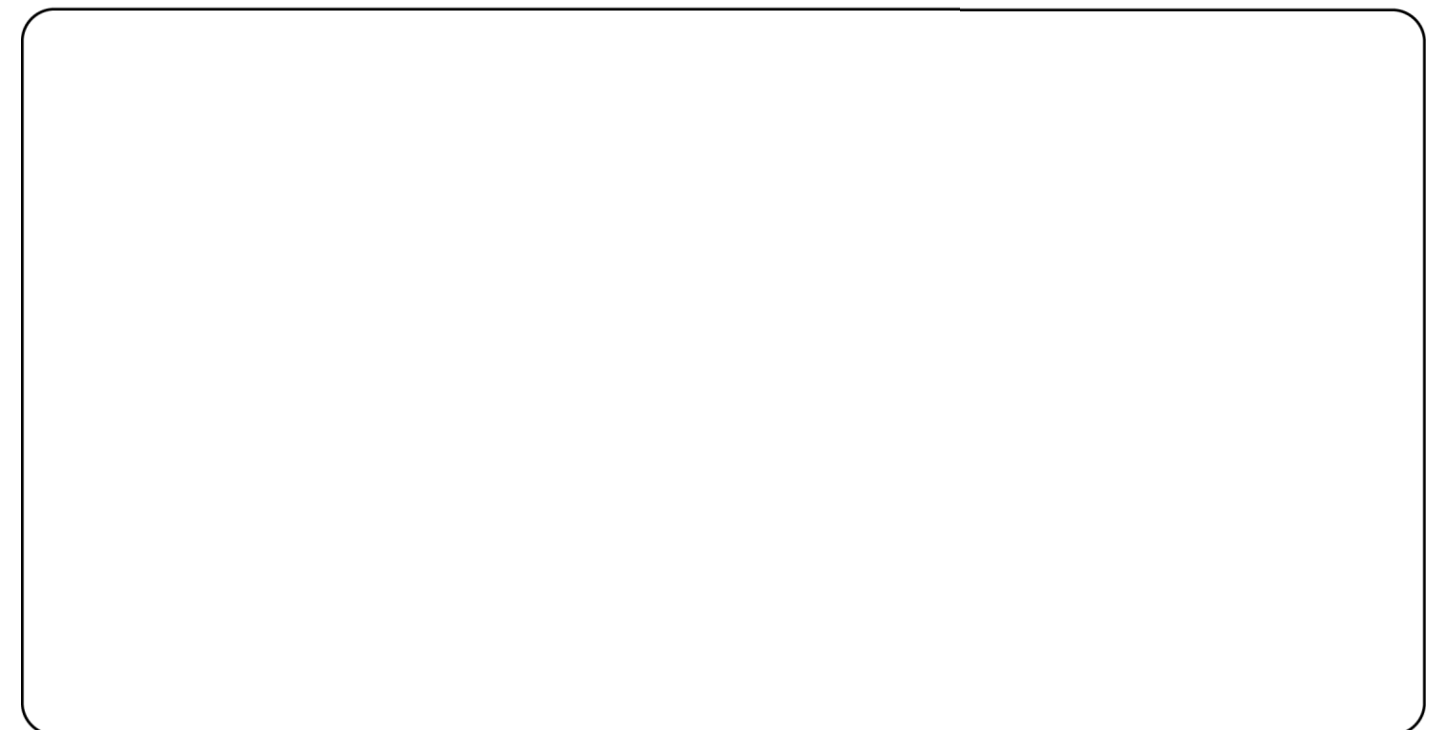

# Peacock

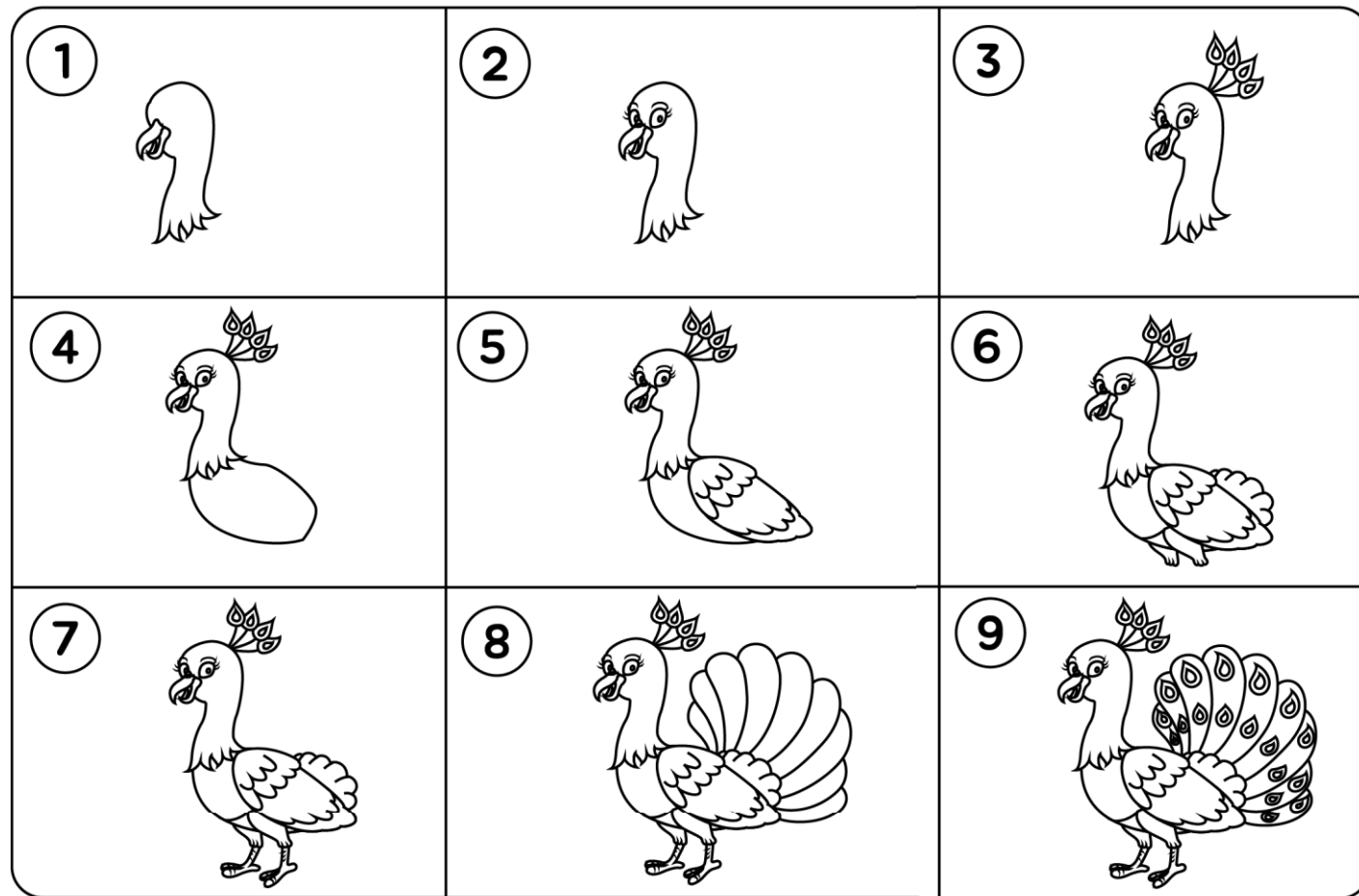

## Practice

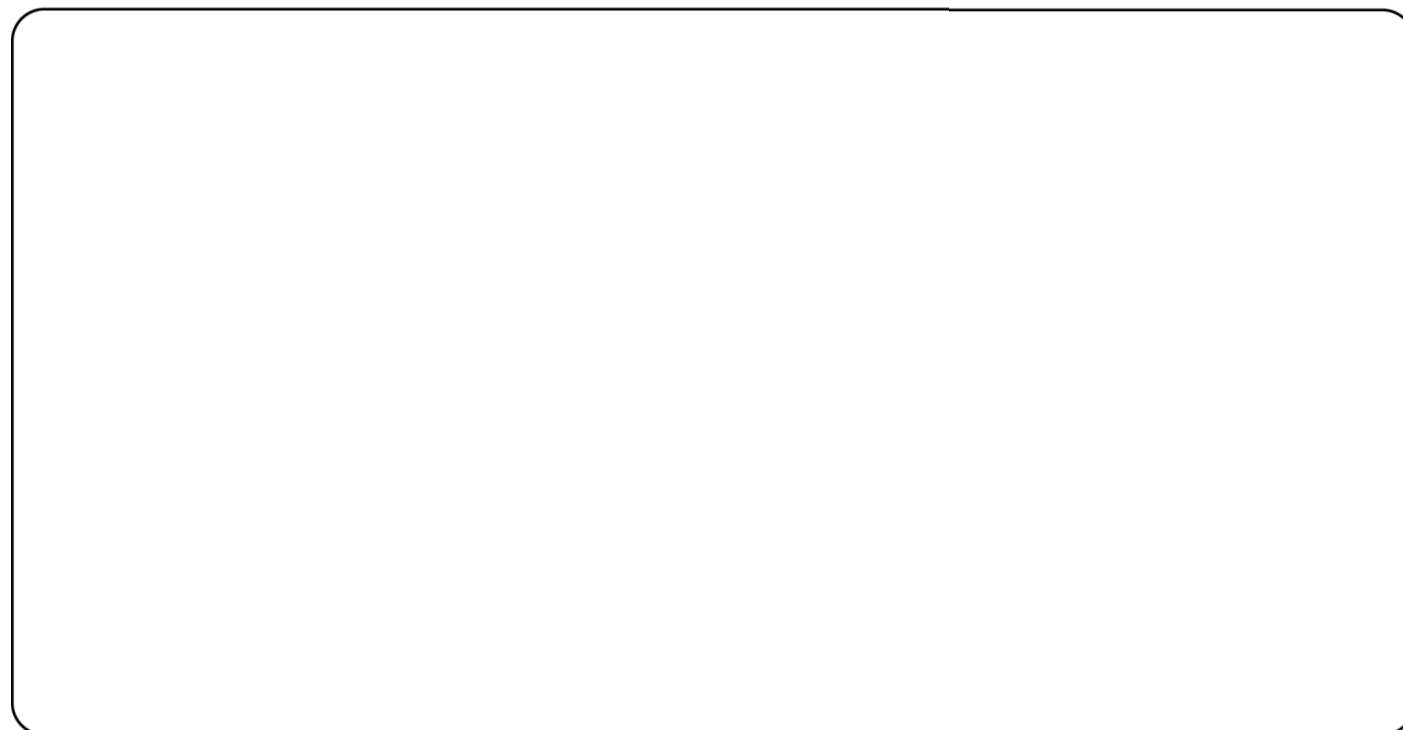

# Mushroom

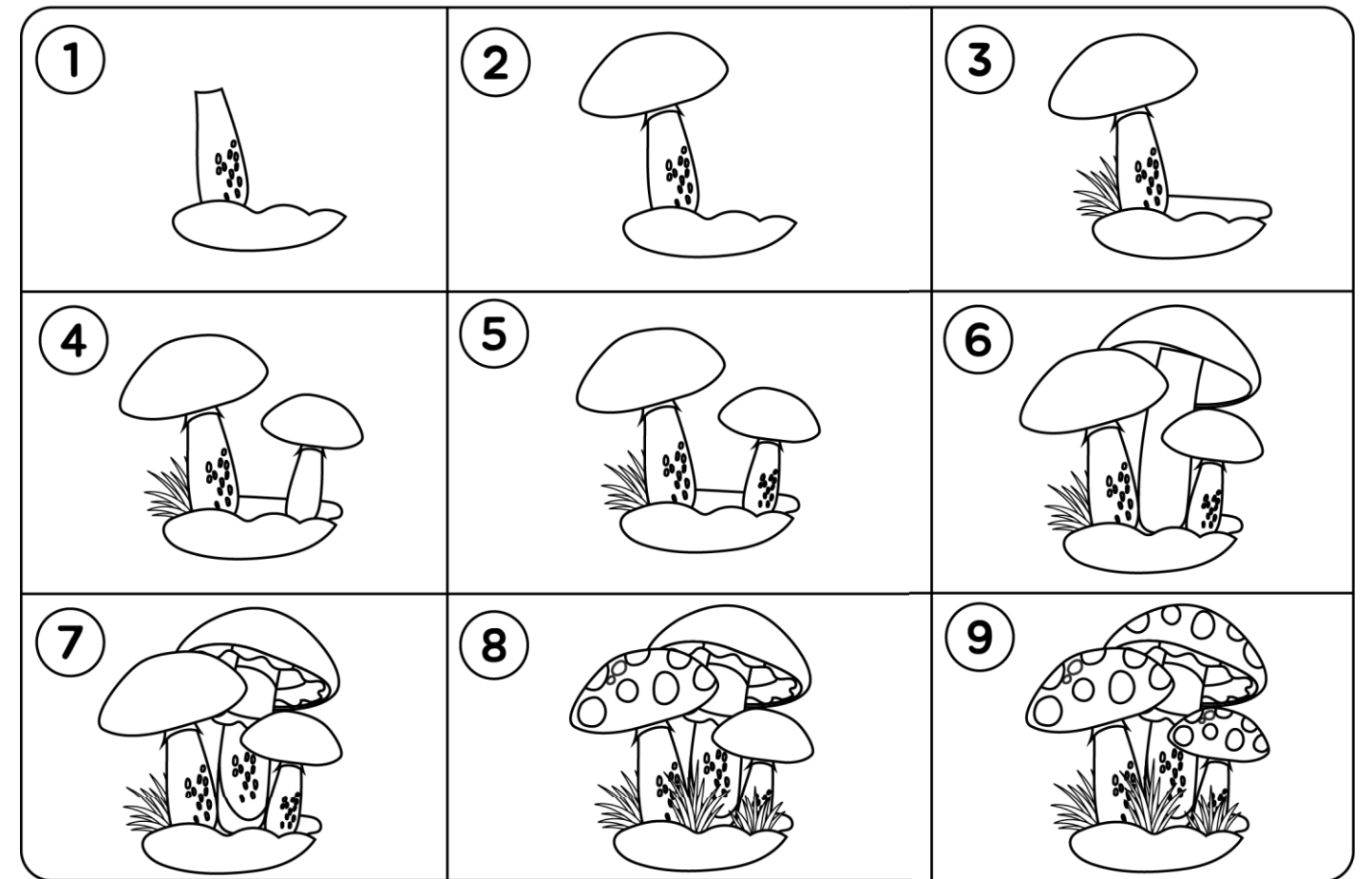

## Practice

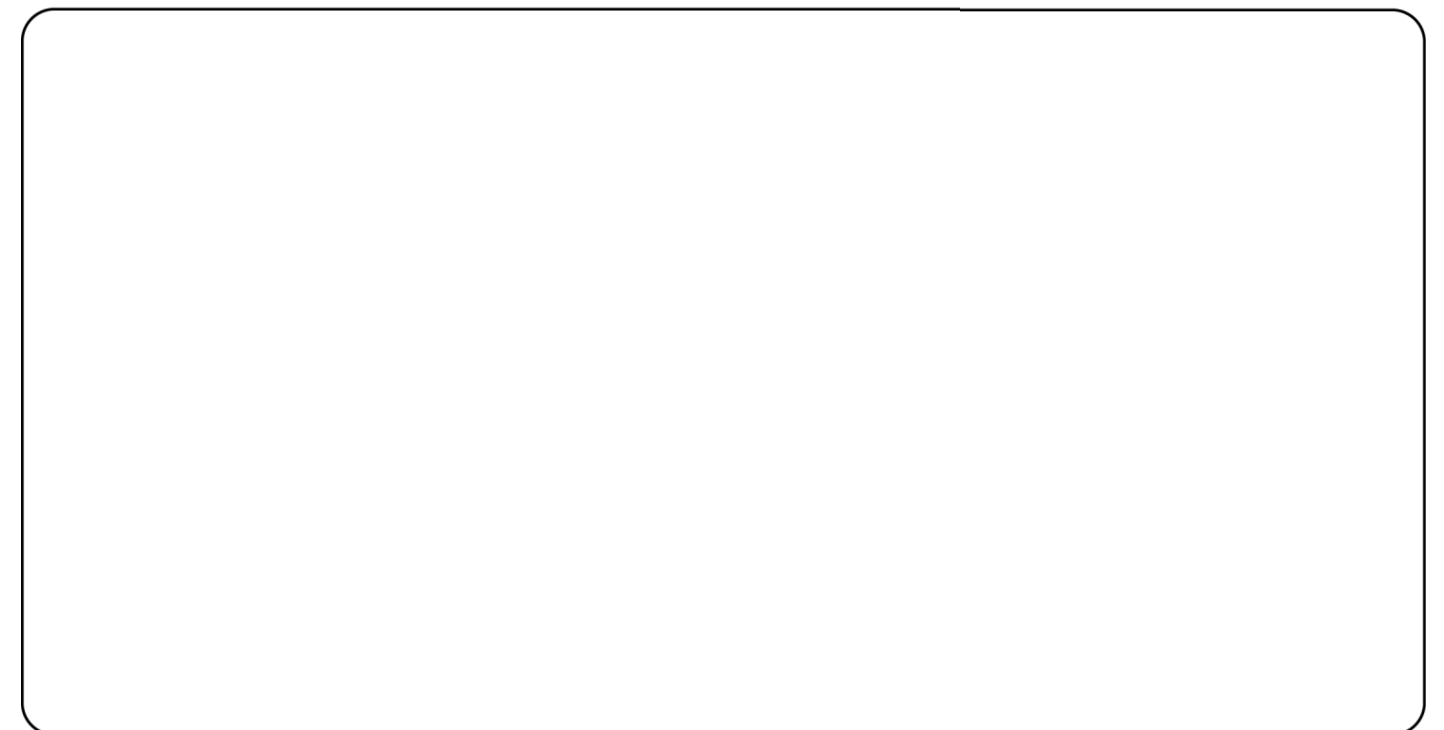

# Pirate

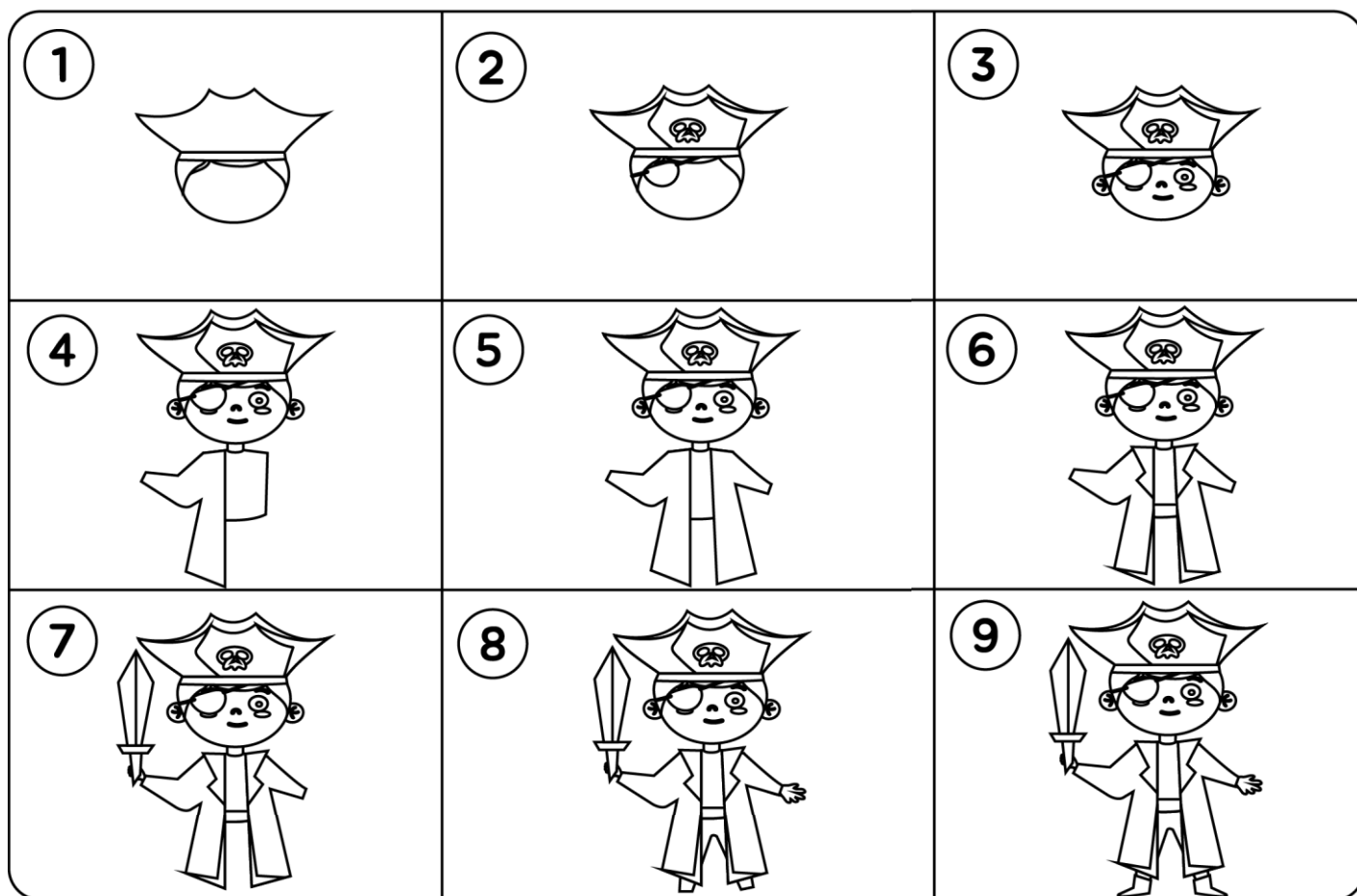

# Practice



# Book

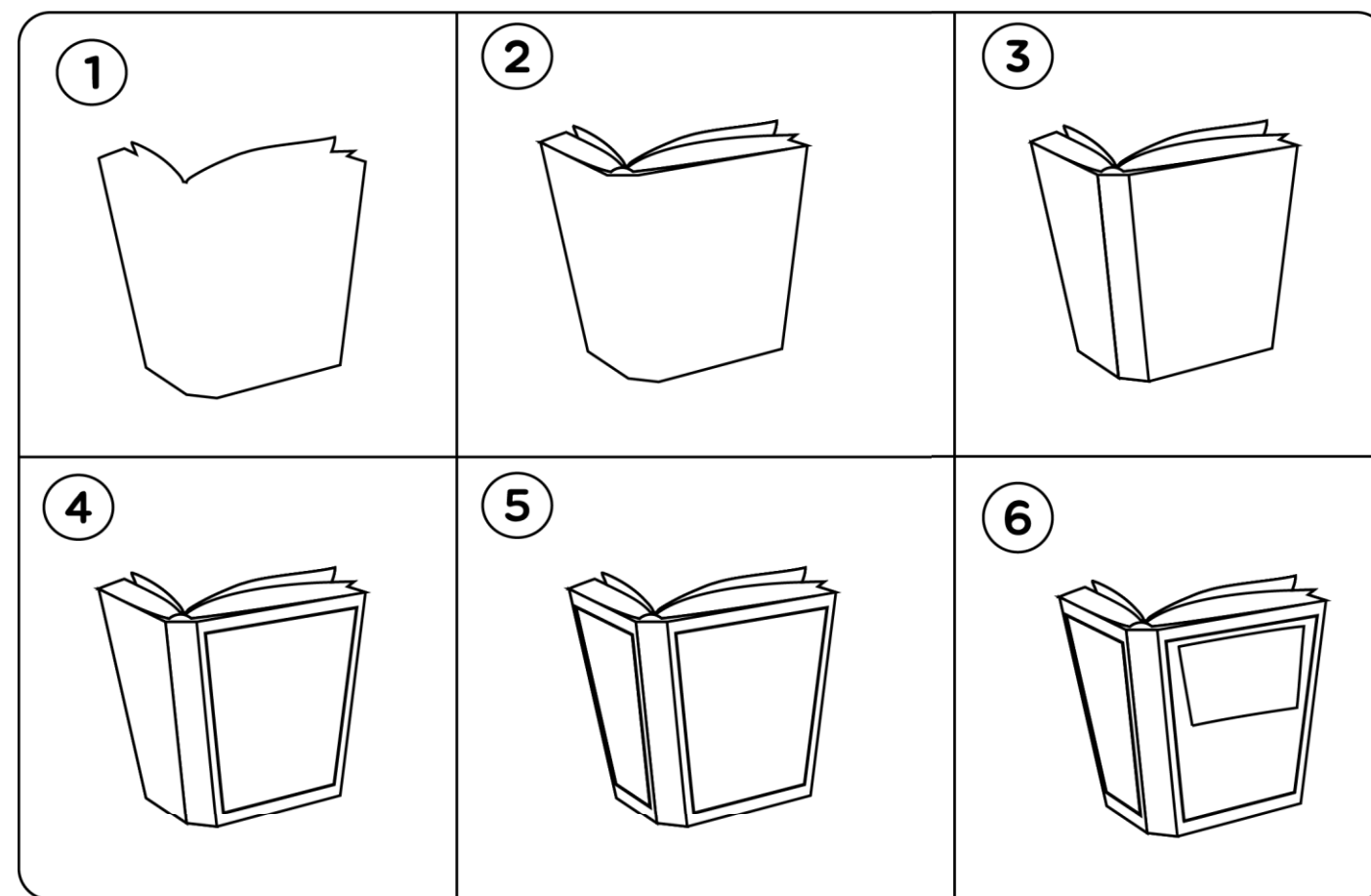

# Practice



# Chef



# Practice

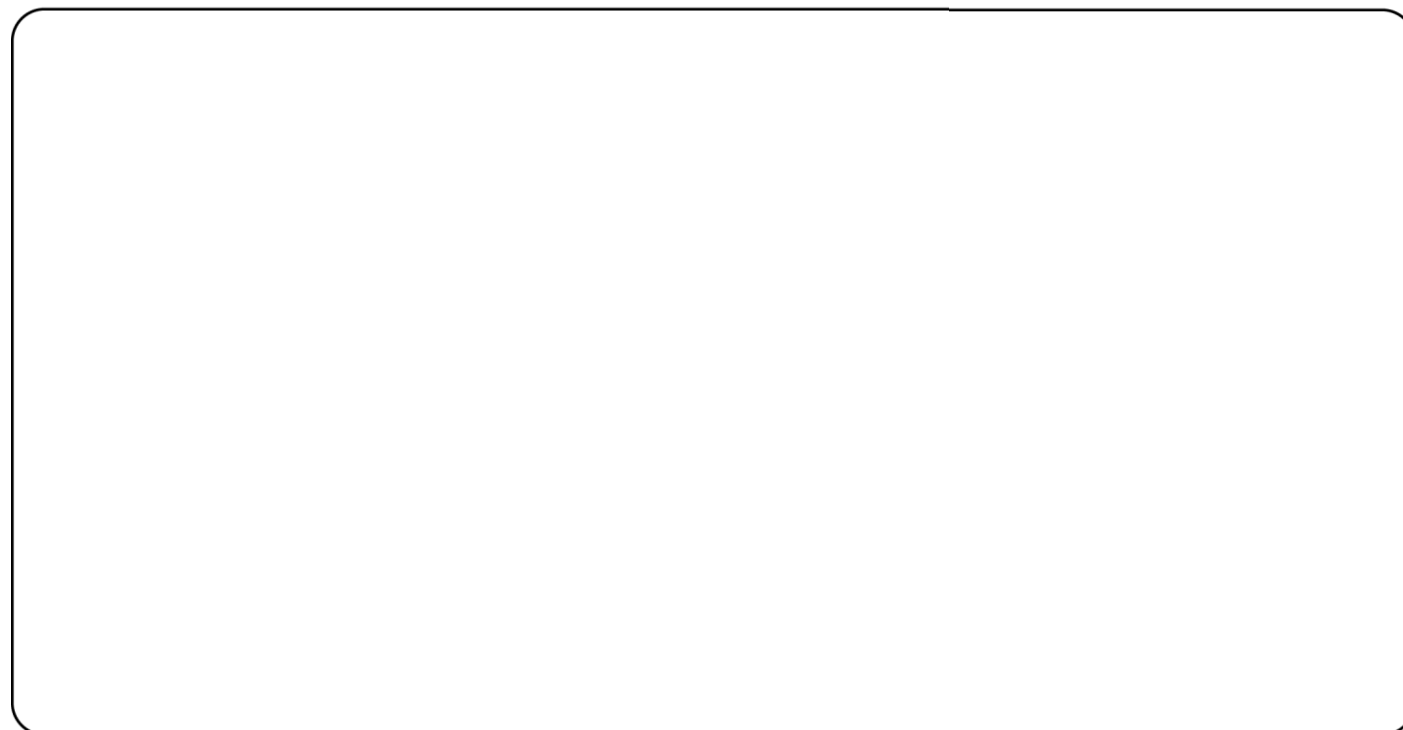

# Umbrella

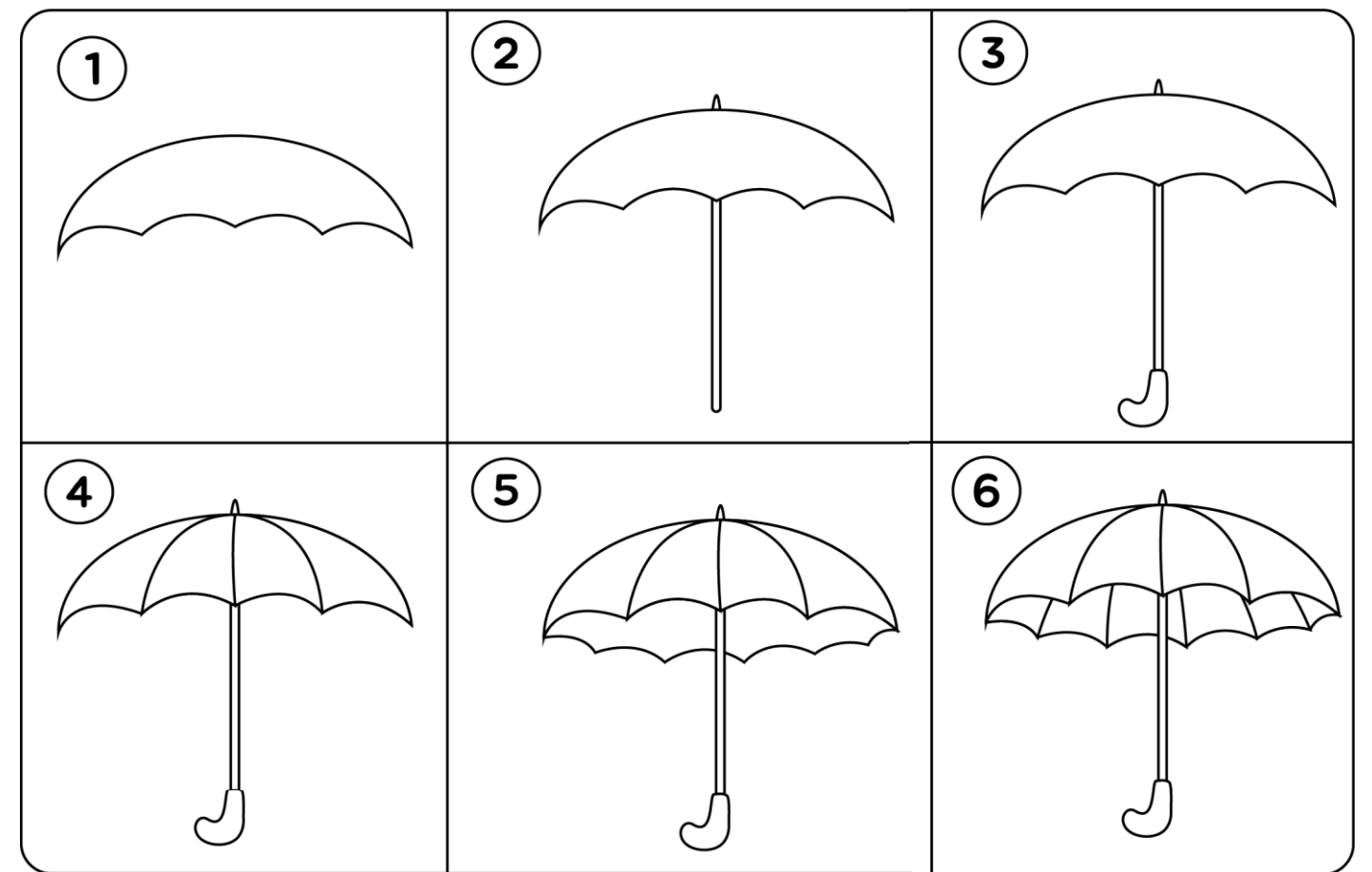

# Practice

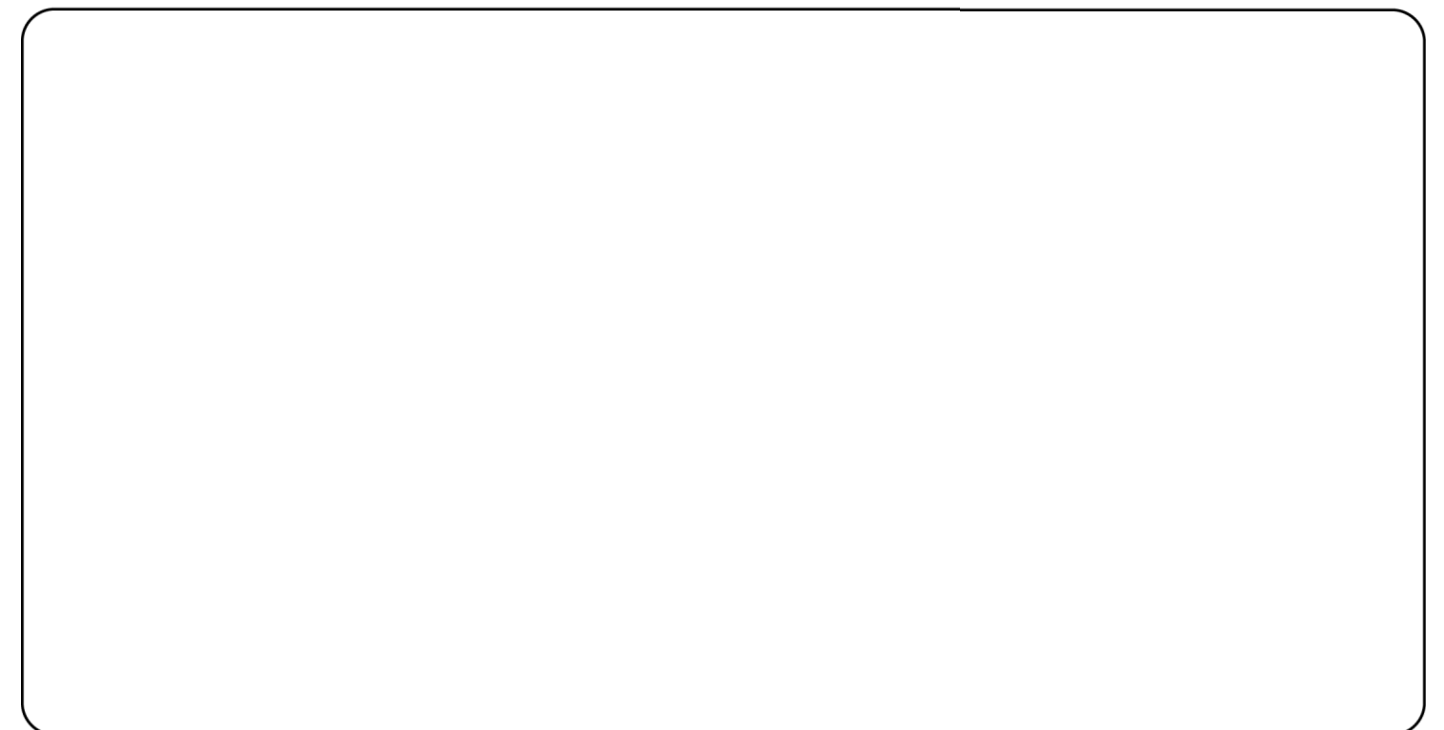

# Bee

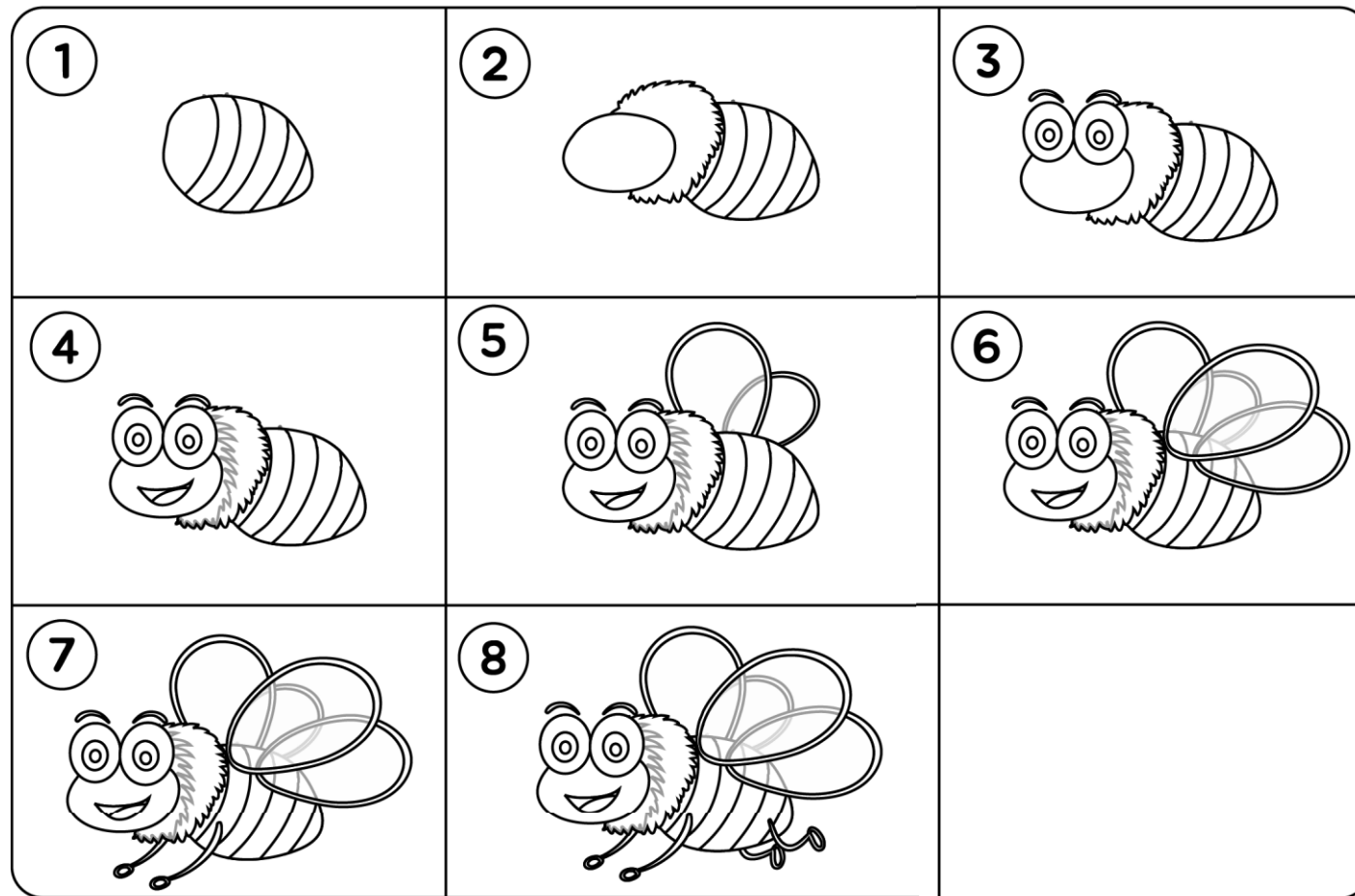

## Practice

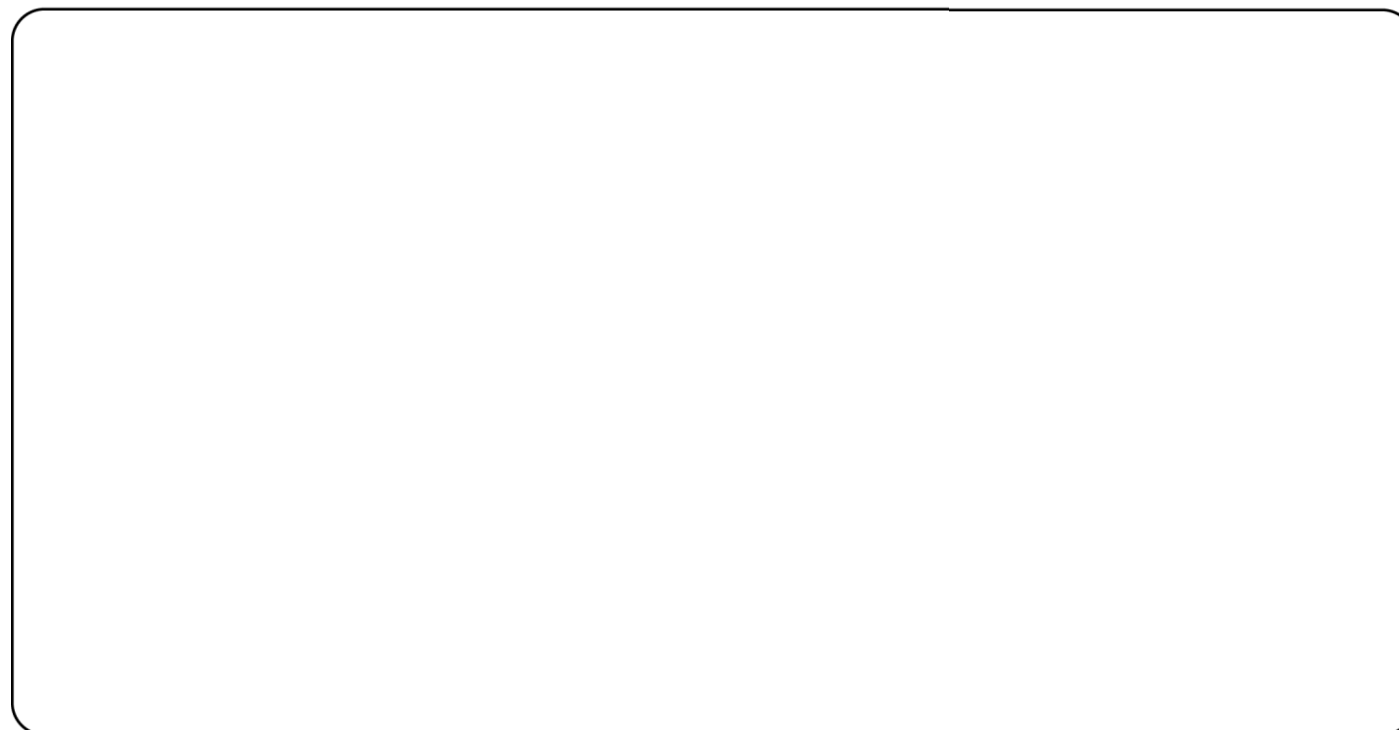

# Potato

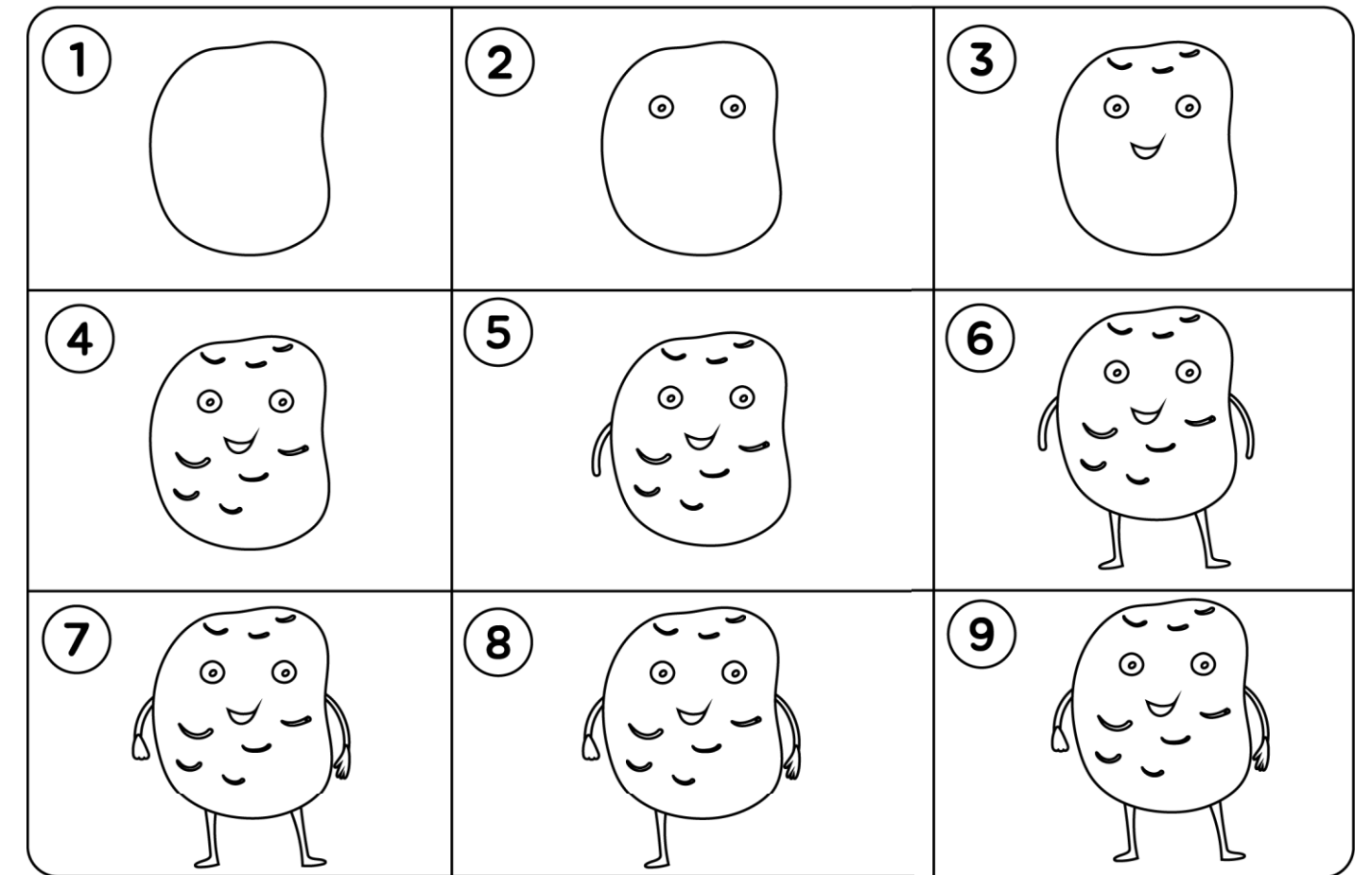

## Practice

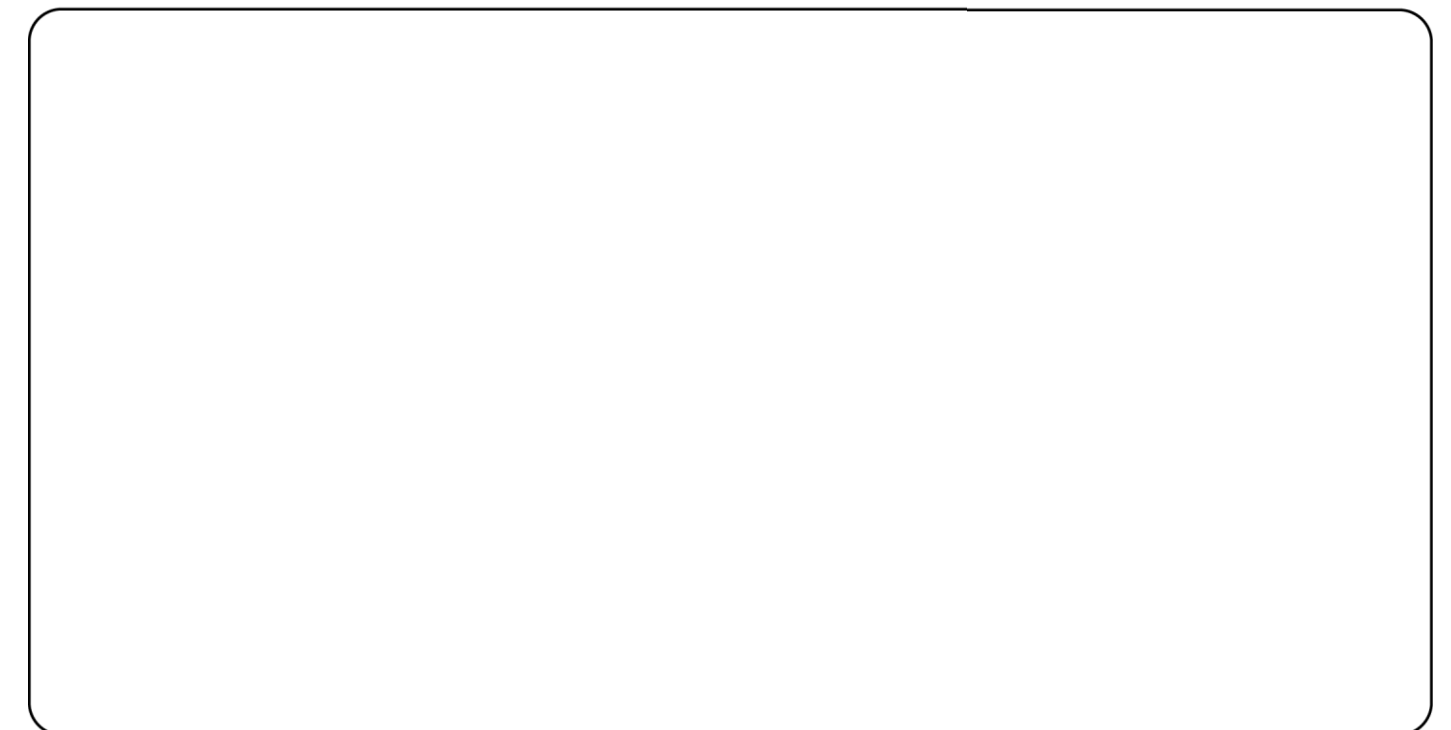

# Unicorn

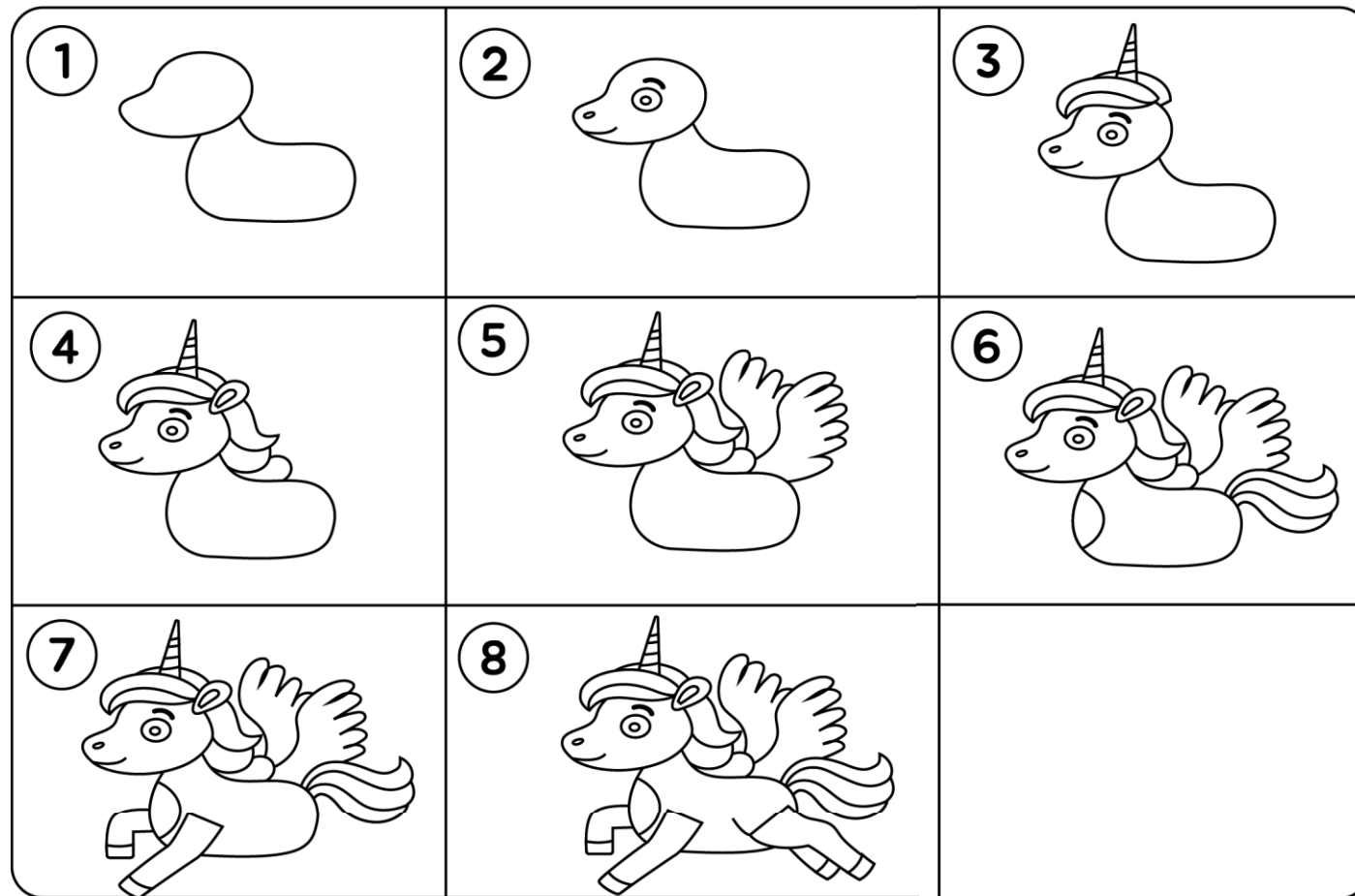

## Practice

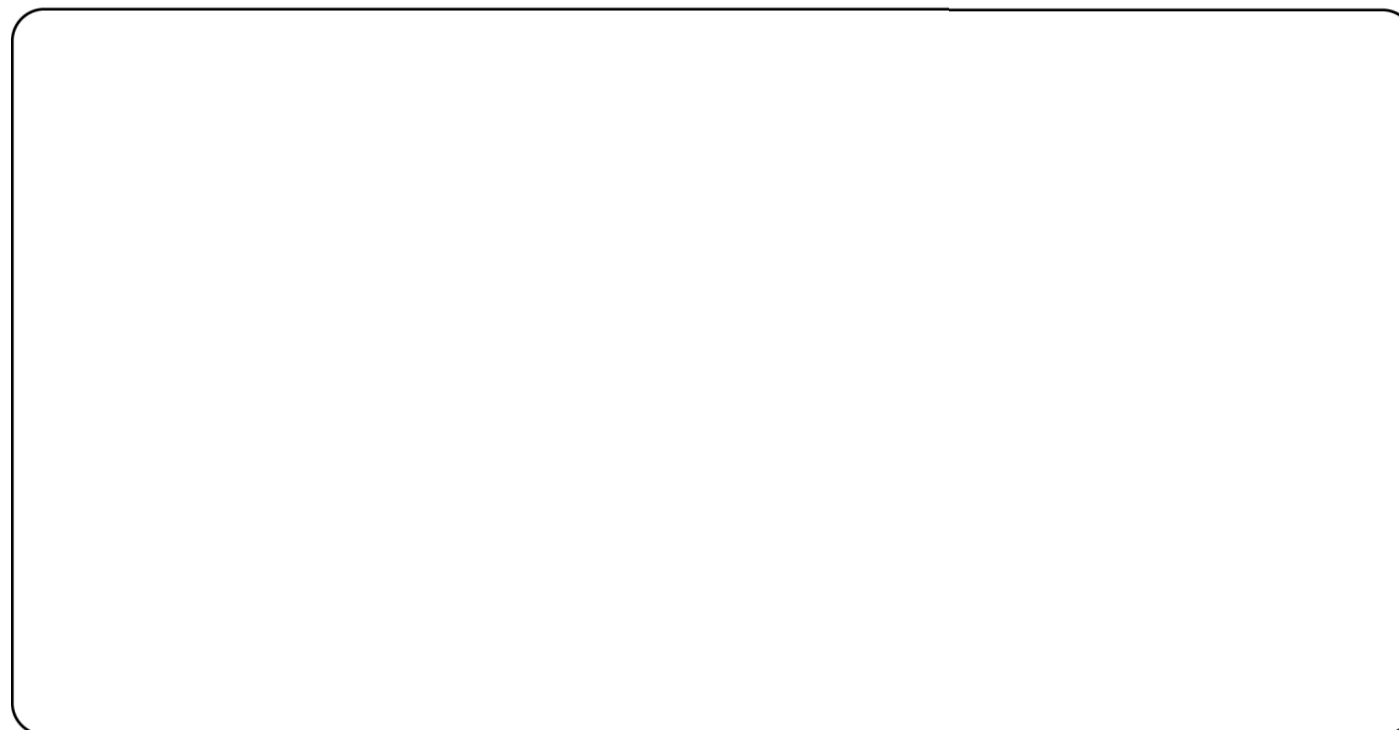

# Sugar Glider

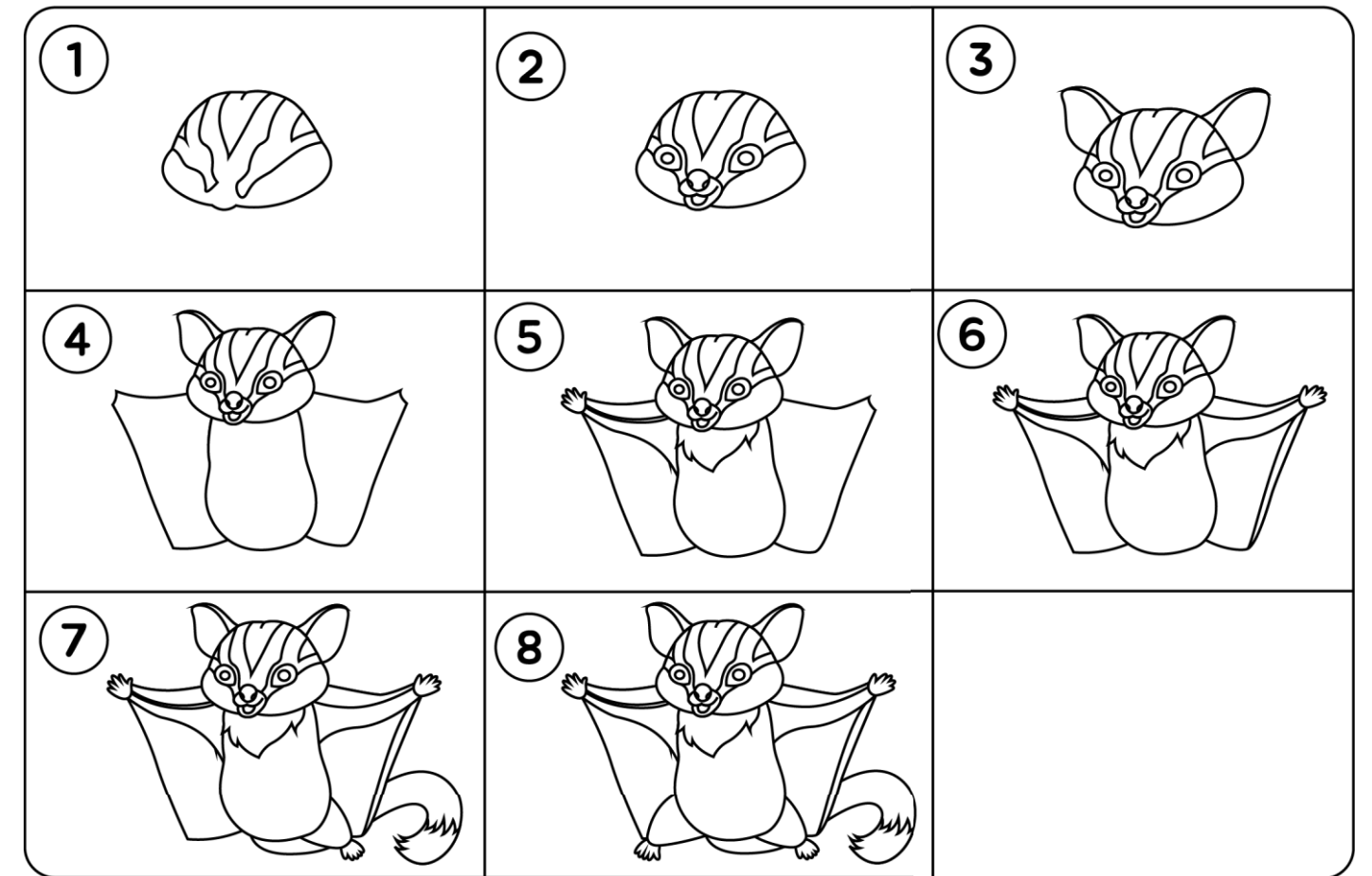

## Practice

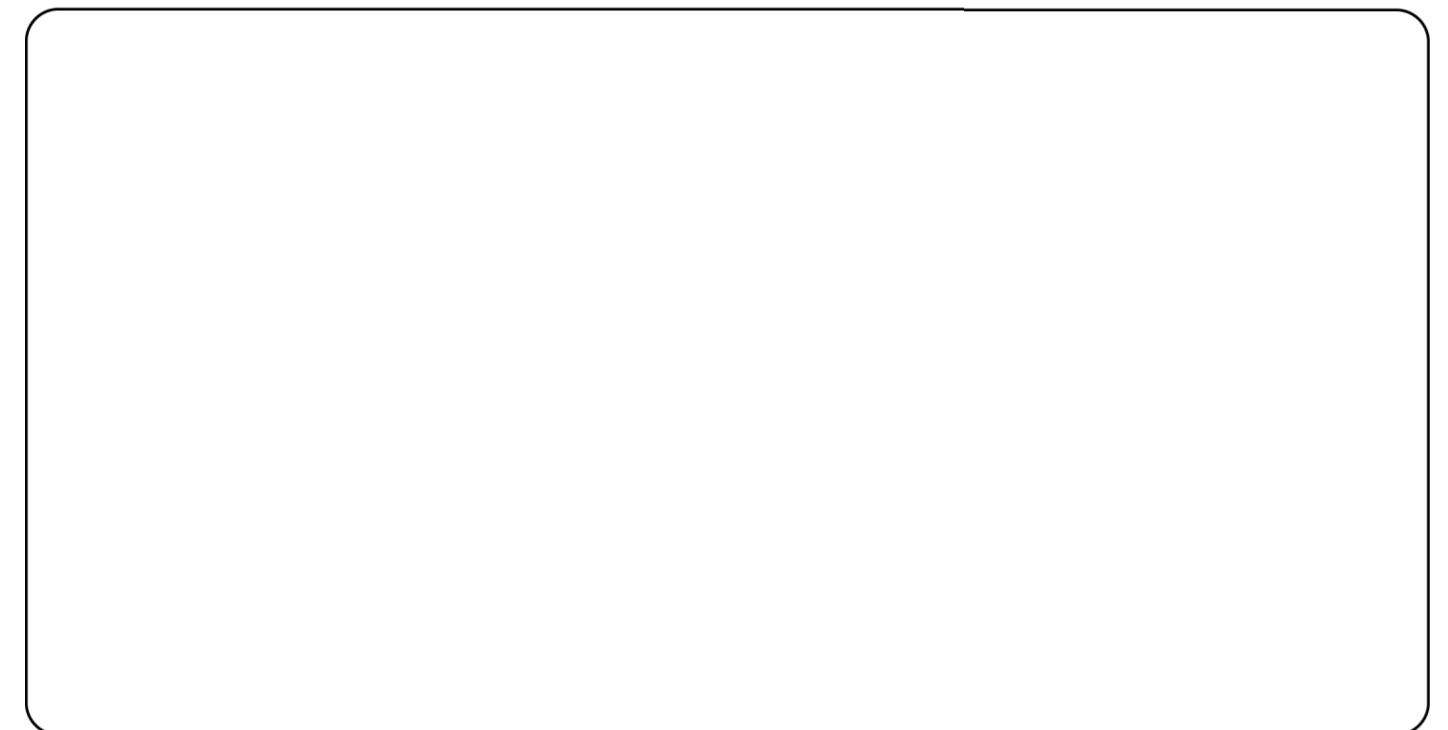

# Rocket

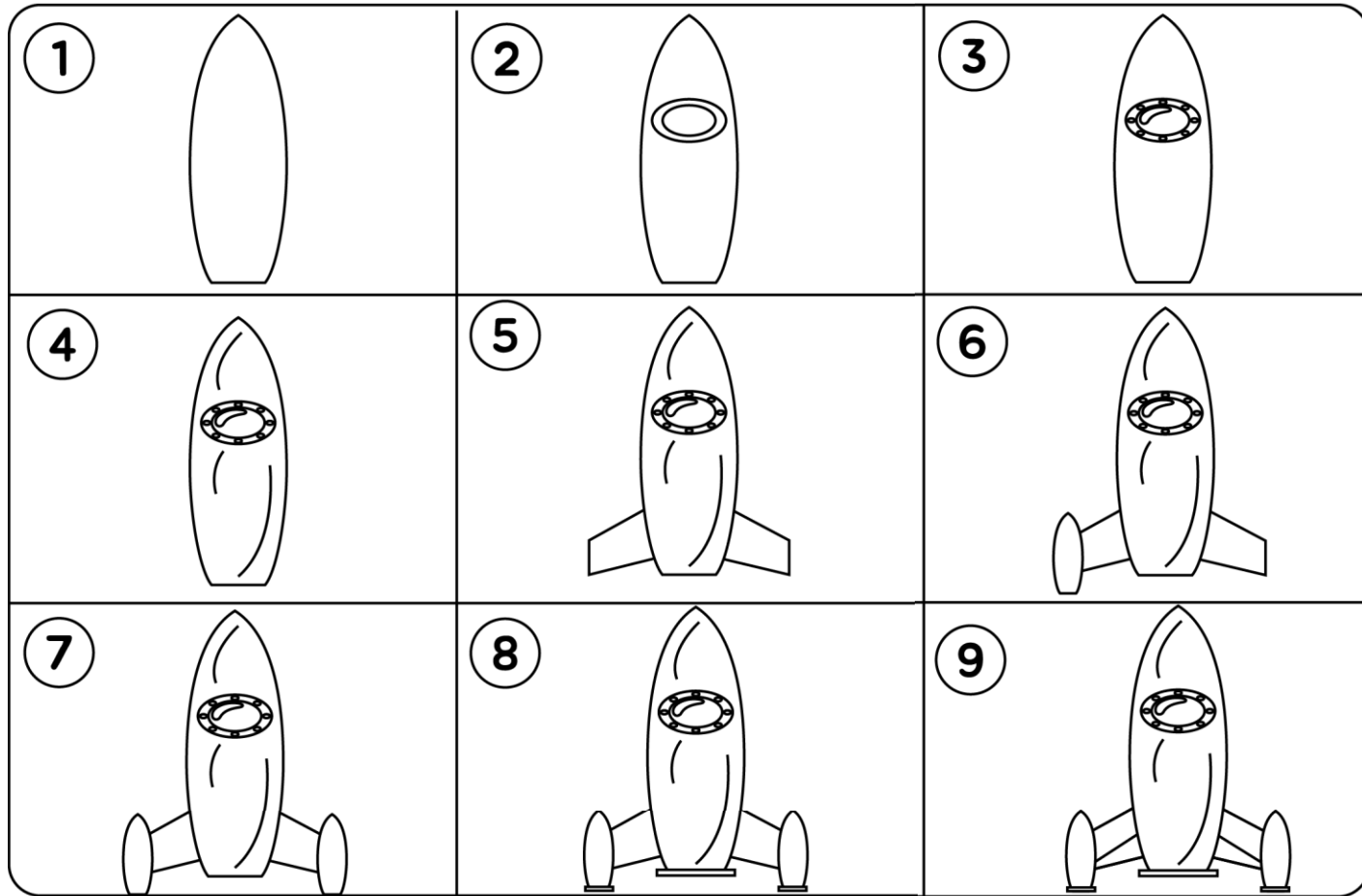

# Practice

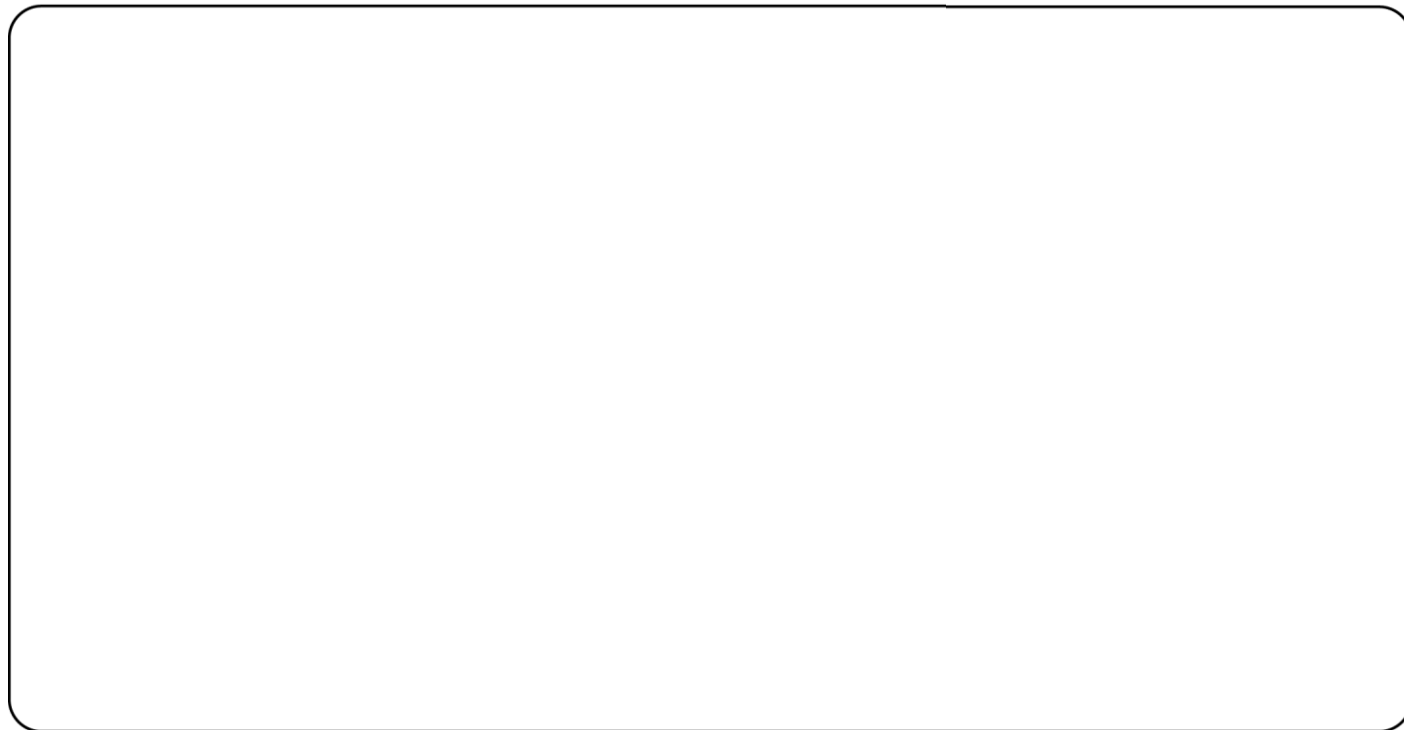

# Santa Claus

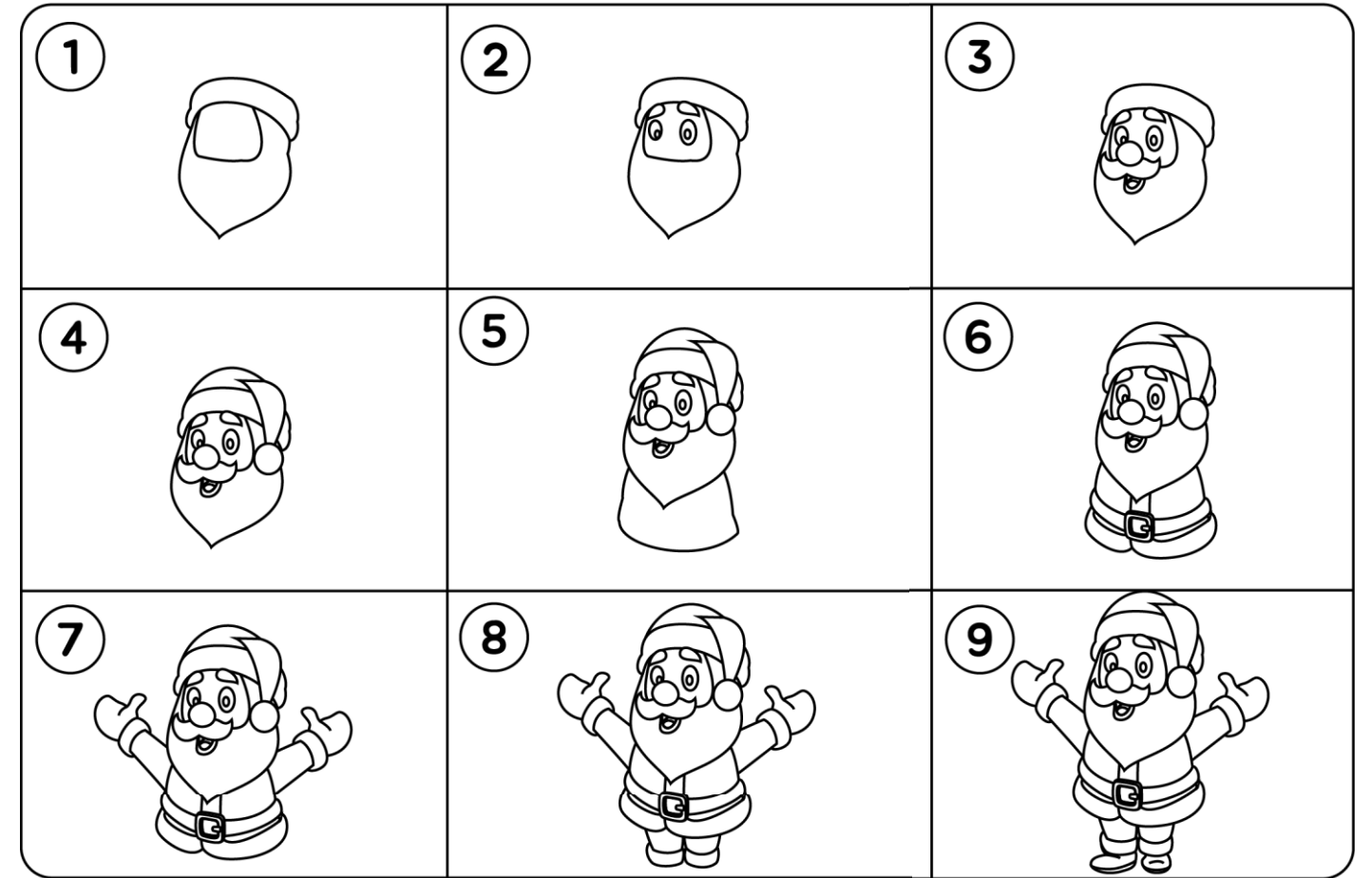

# Practice

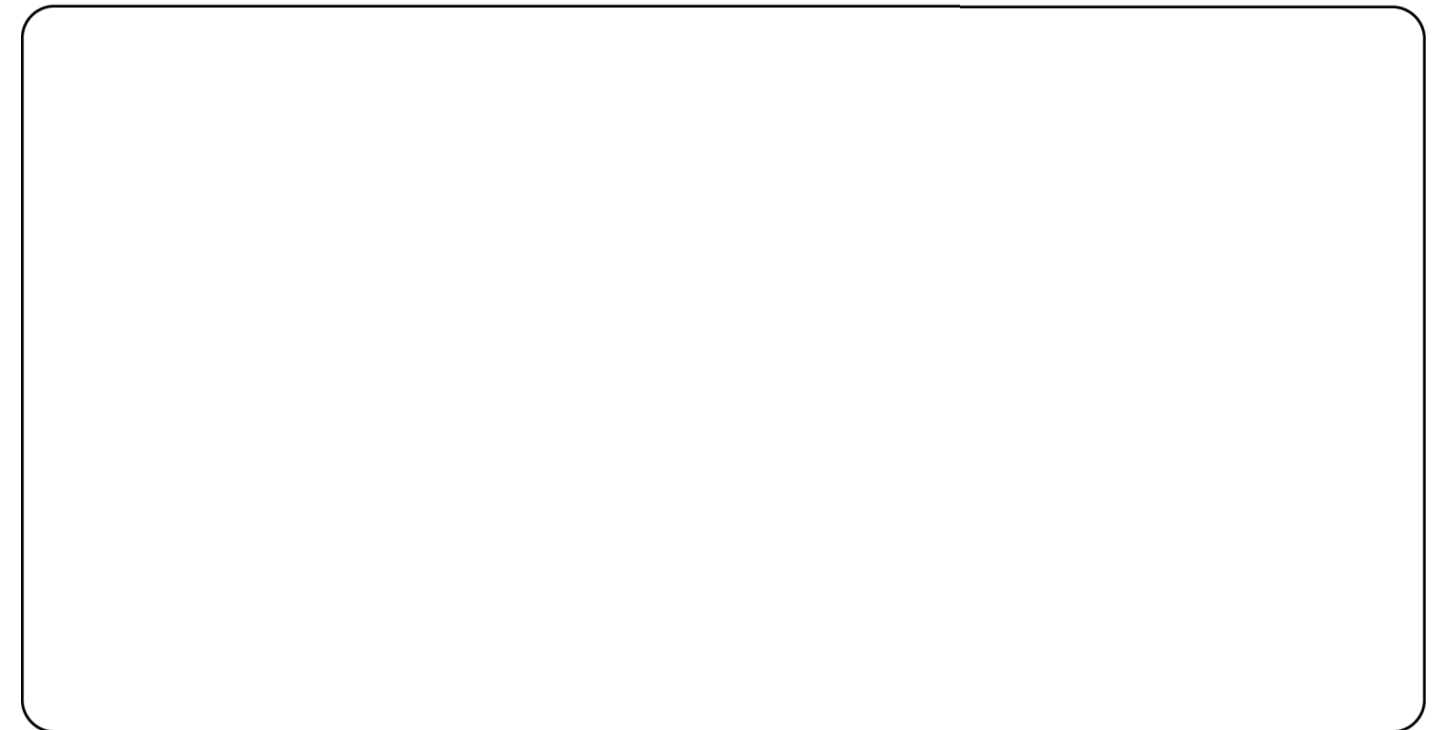

# Sponge Bob

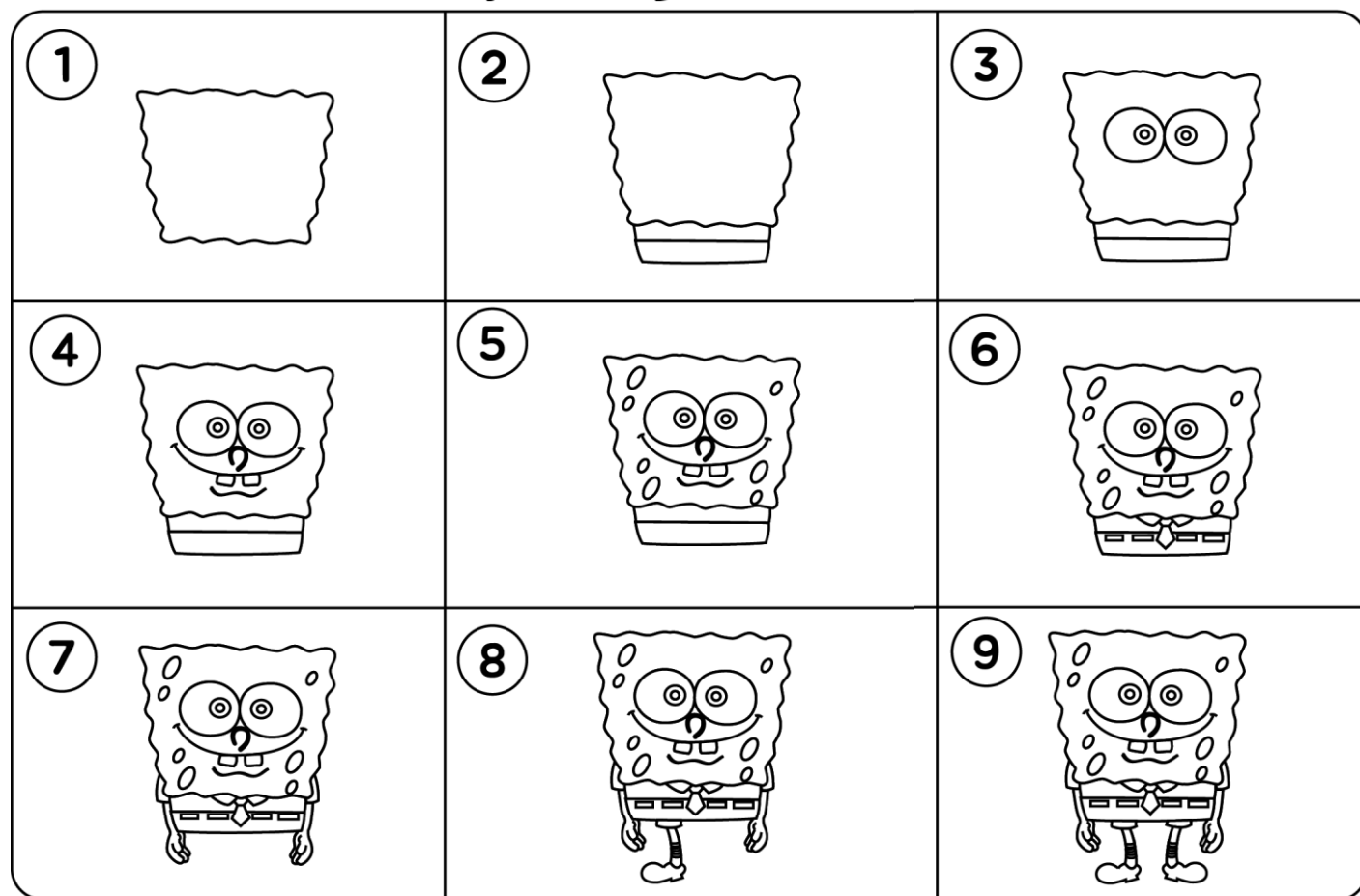

## Practice



# Telephone

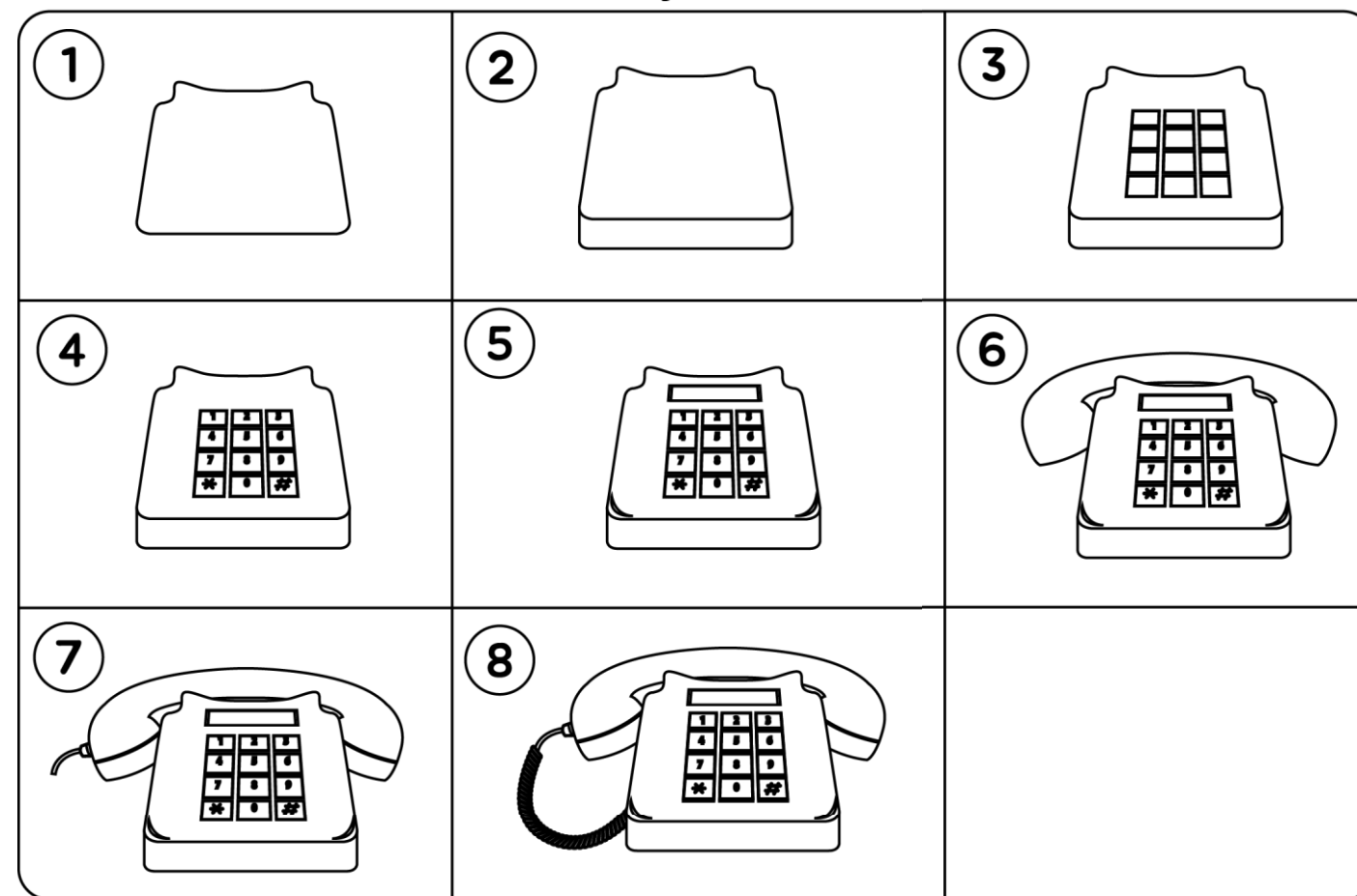

## Practice



# Bear

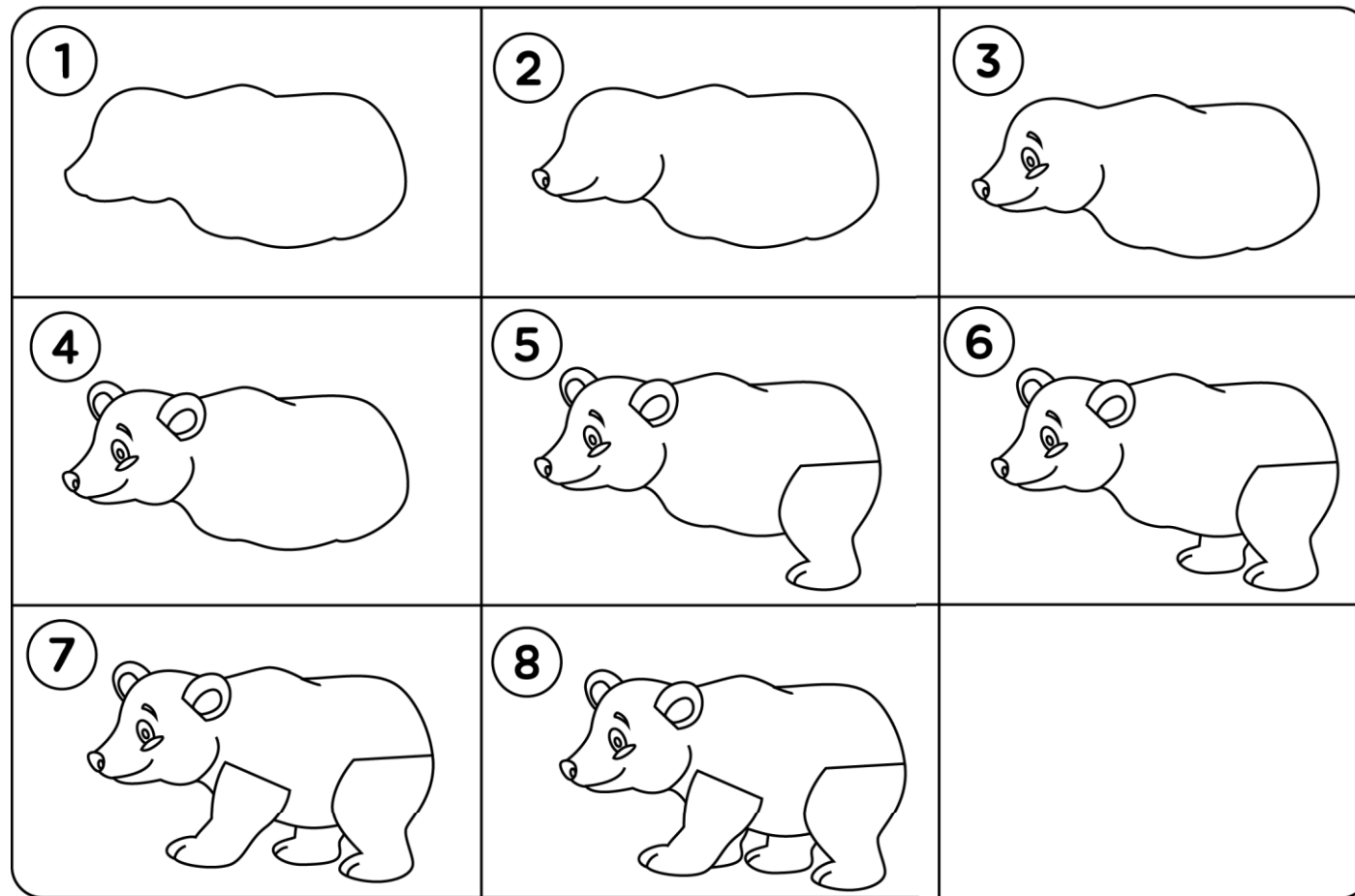

## Practice

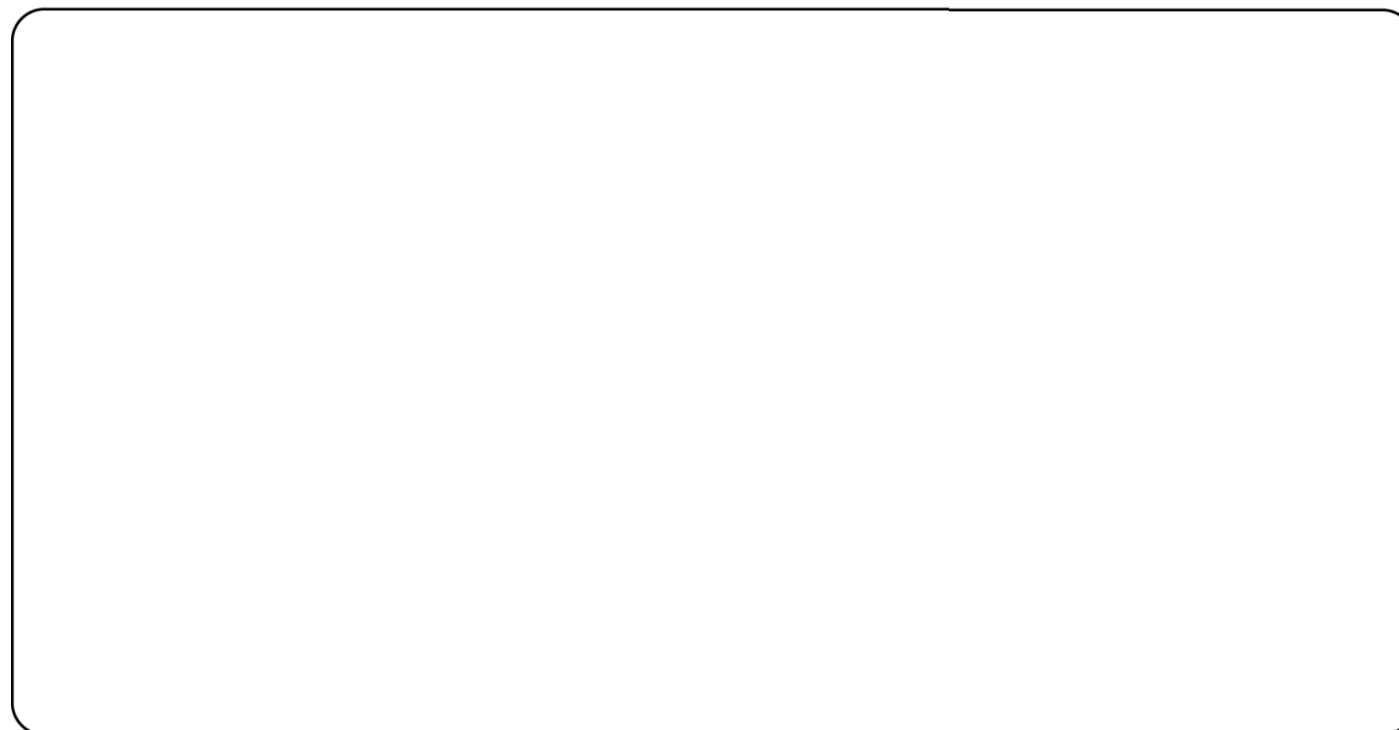

# Dinosaur

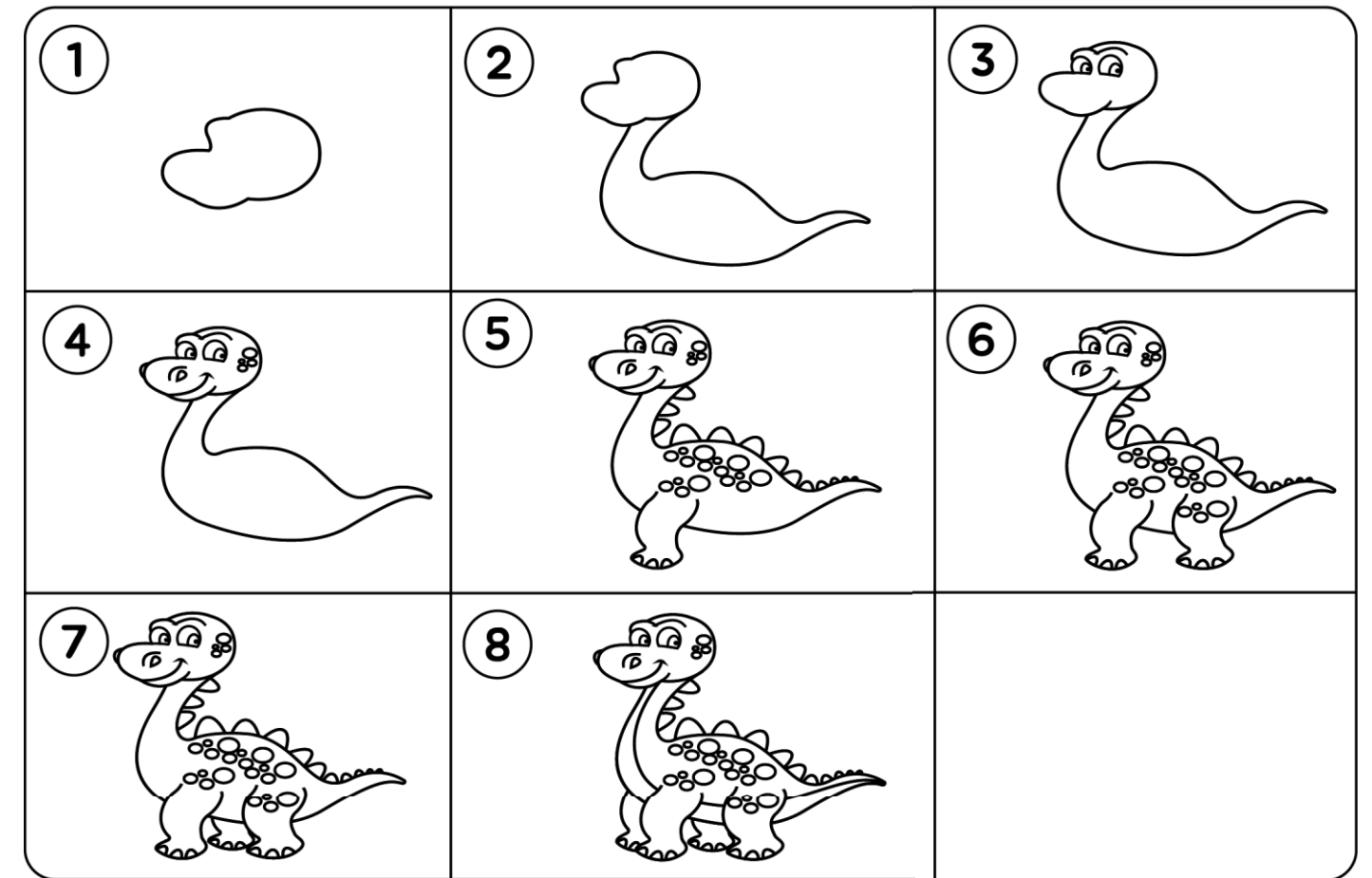

## Practice

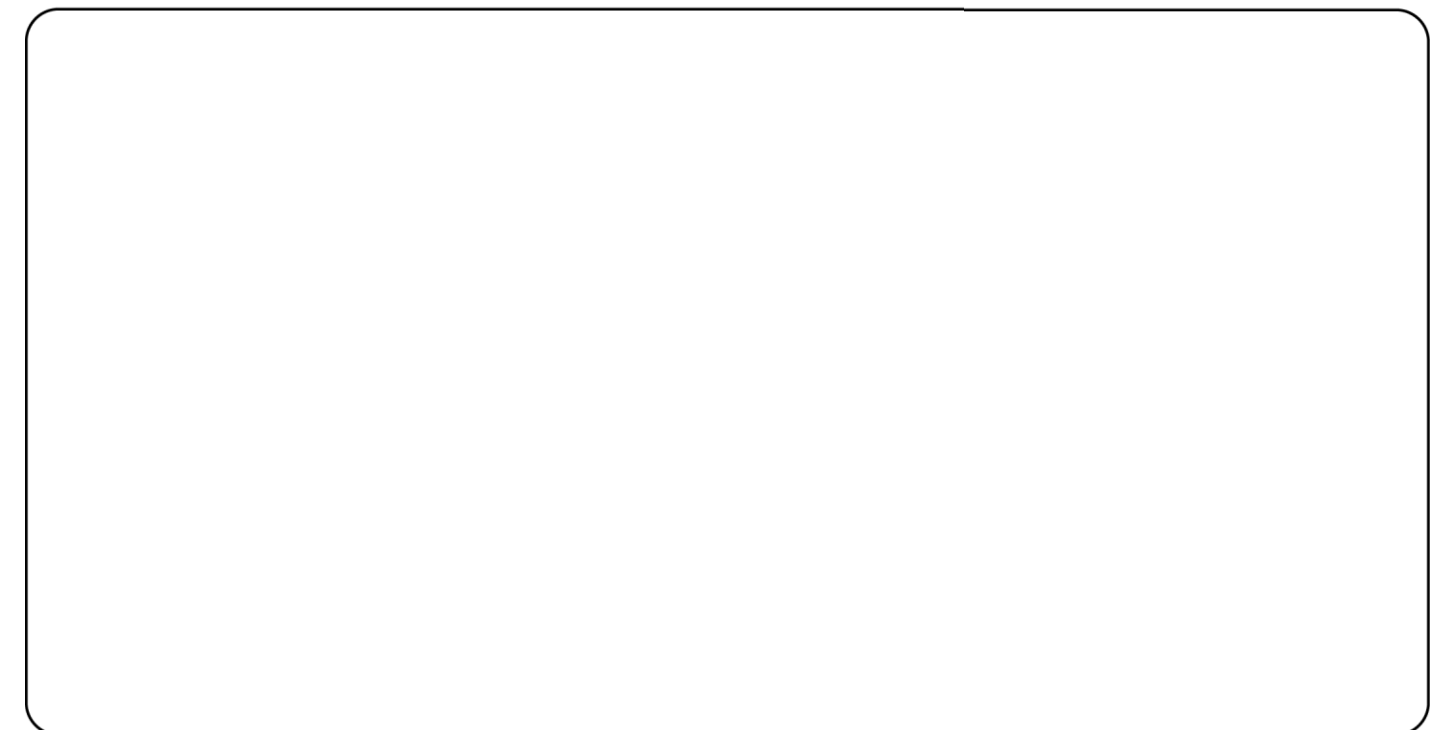

# Chicken

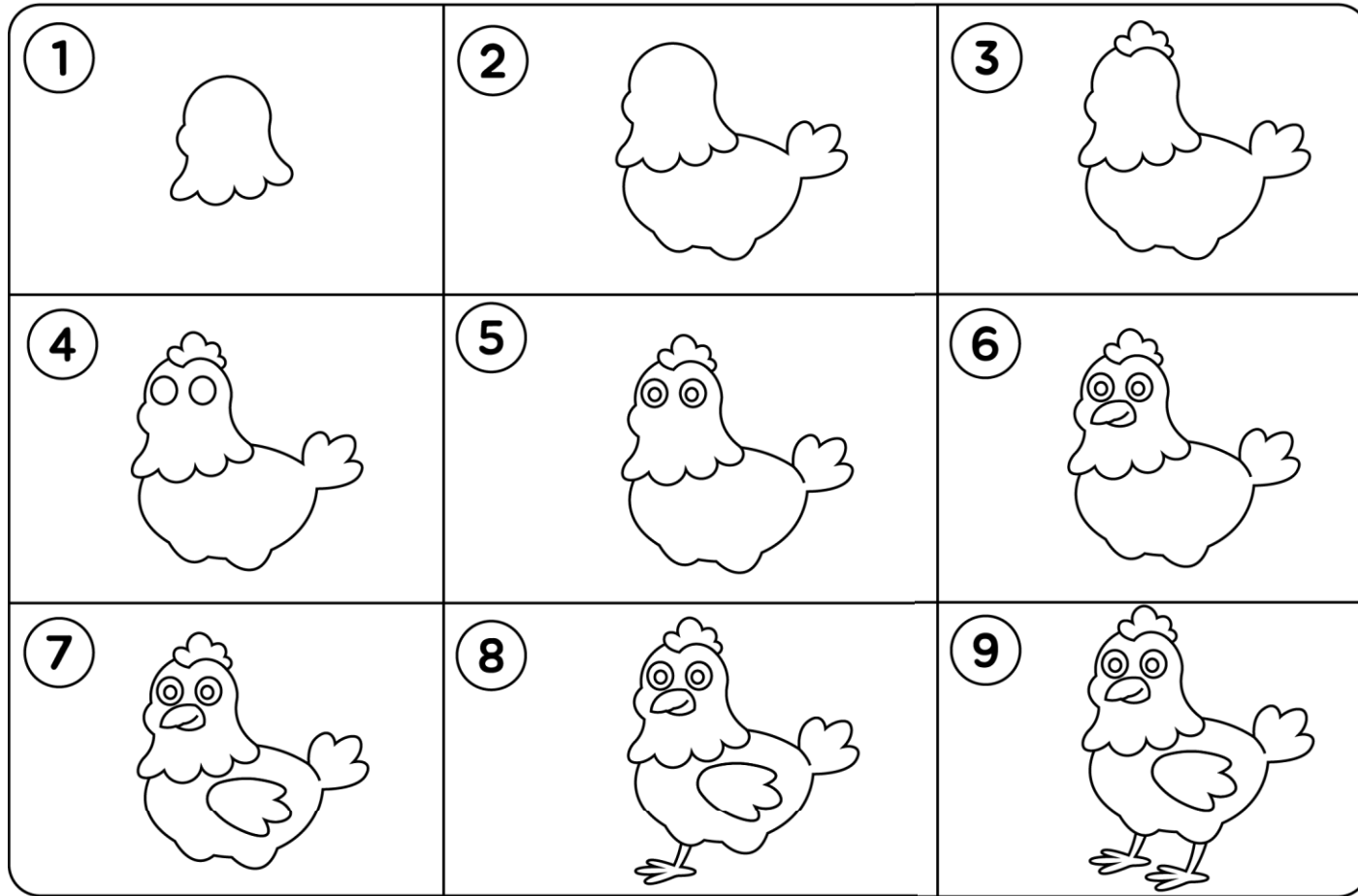

# Practice

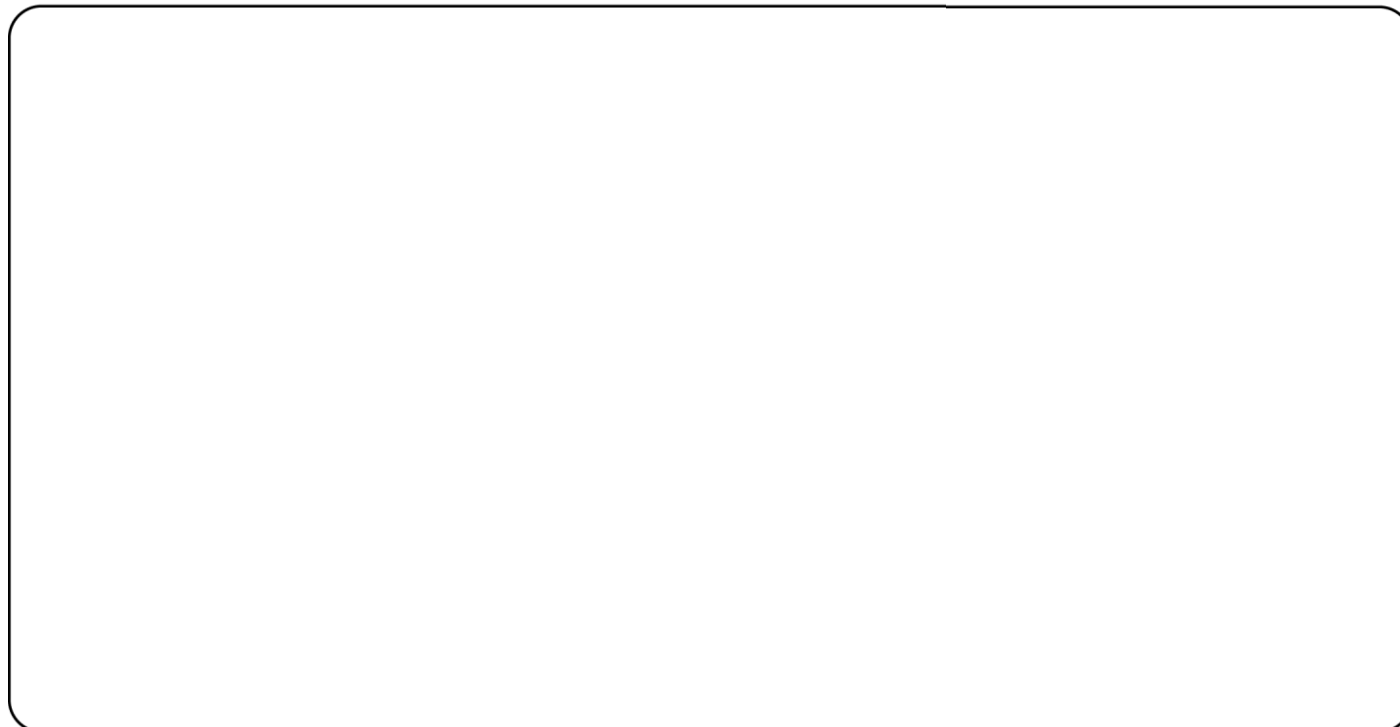

# Shoe

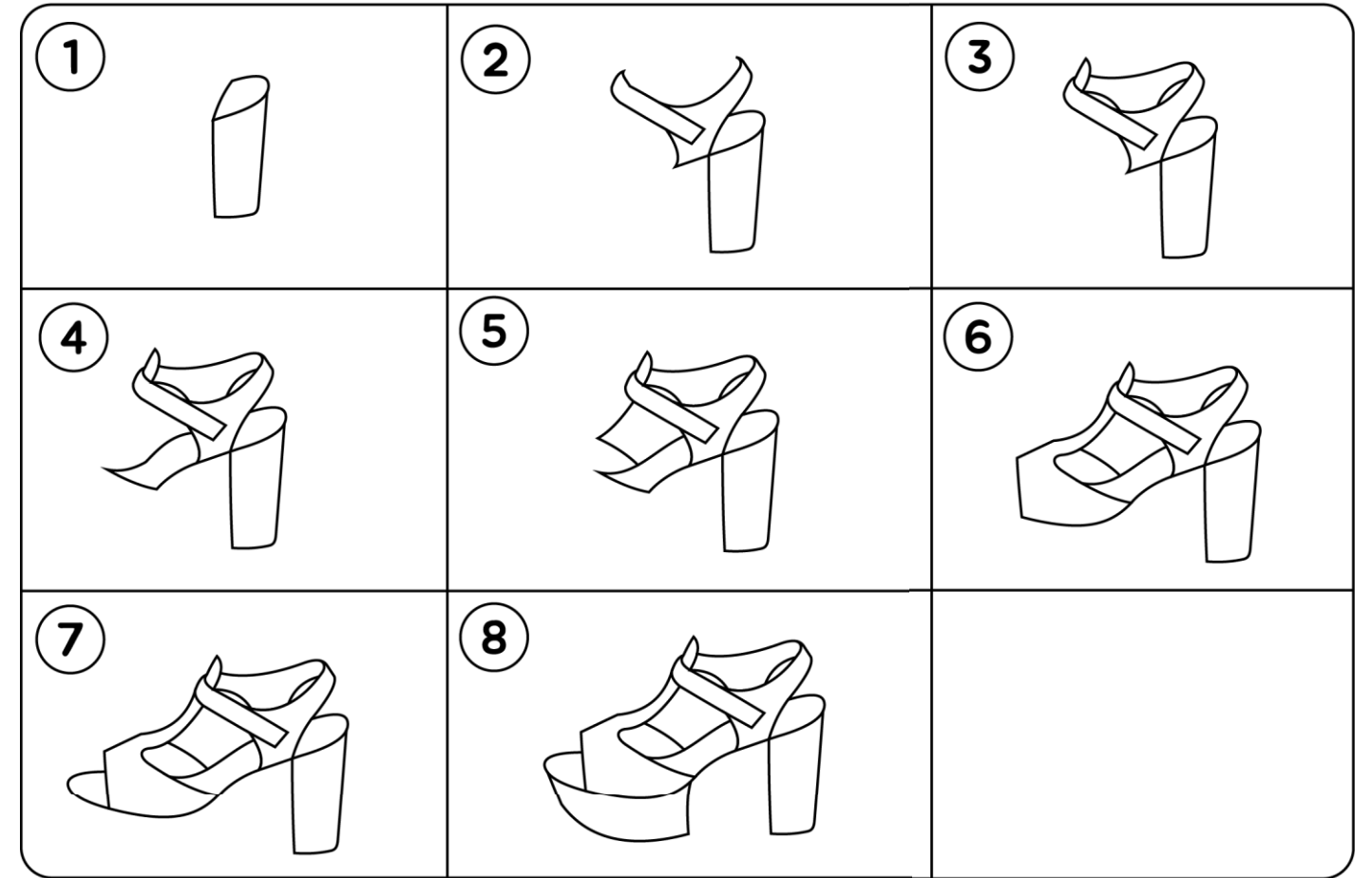

# Practice

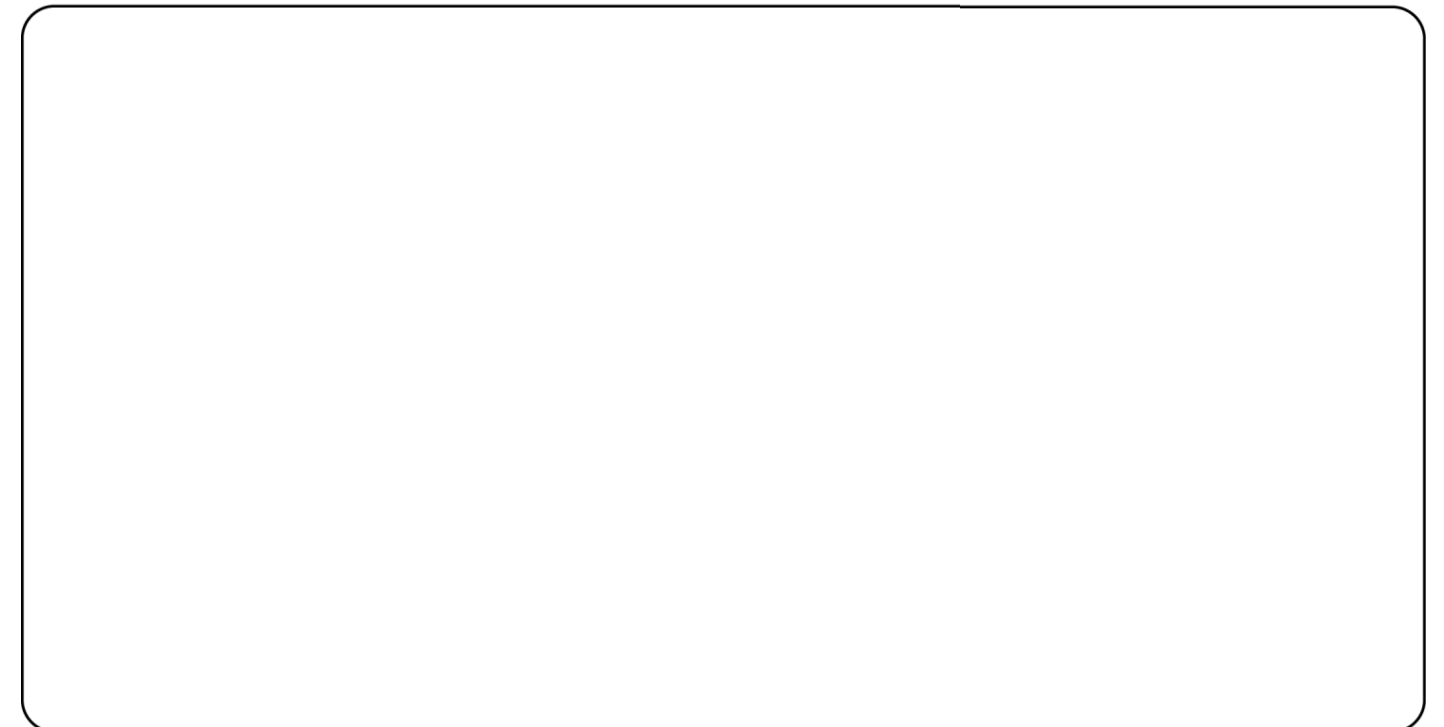

# Tank

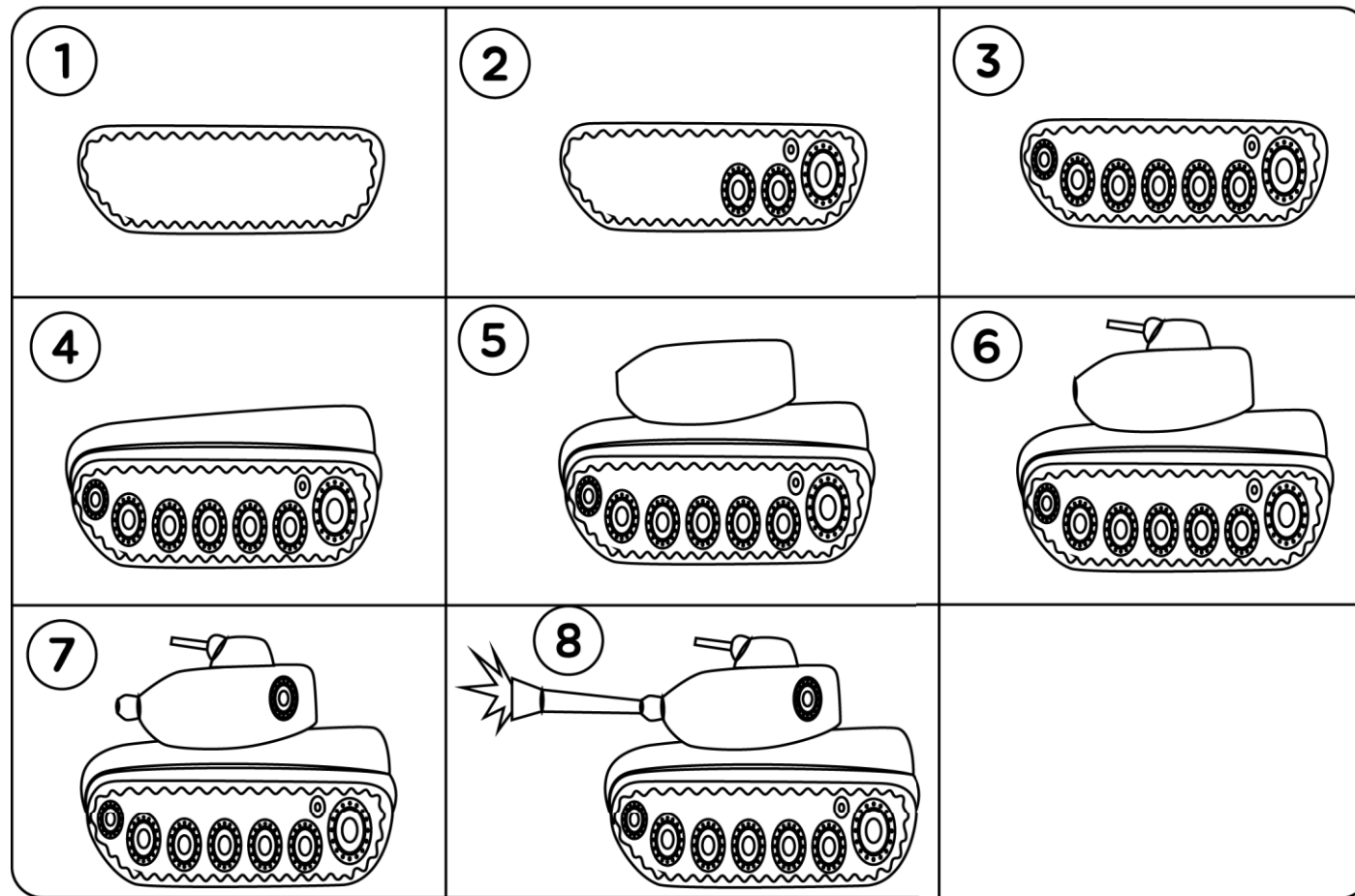

## Practice

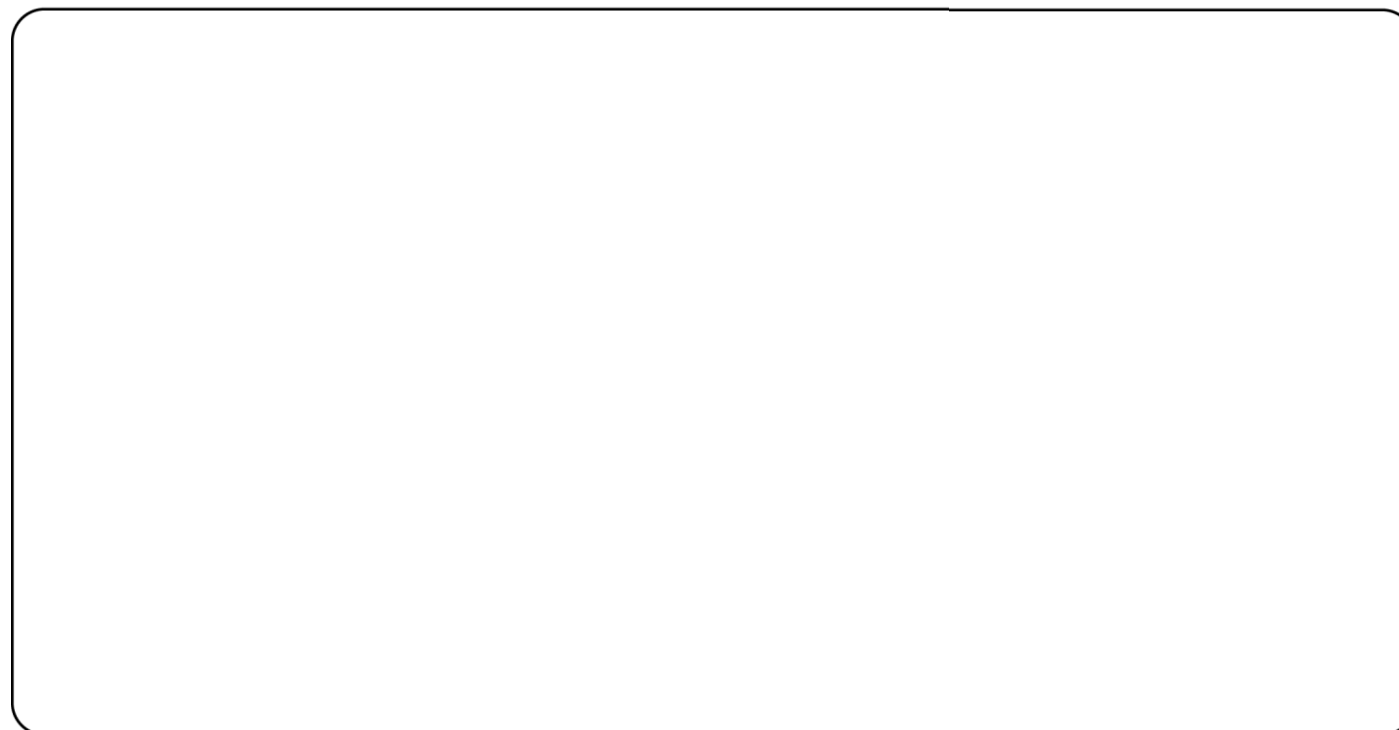

# Car

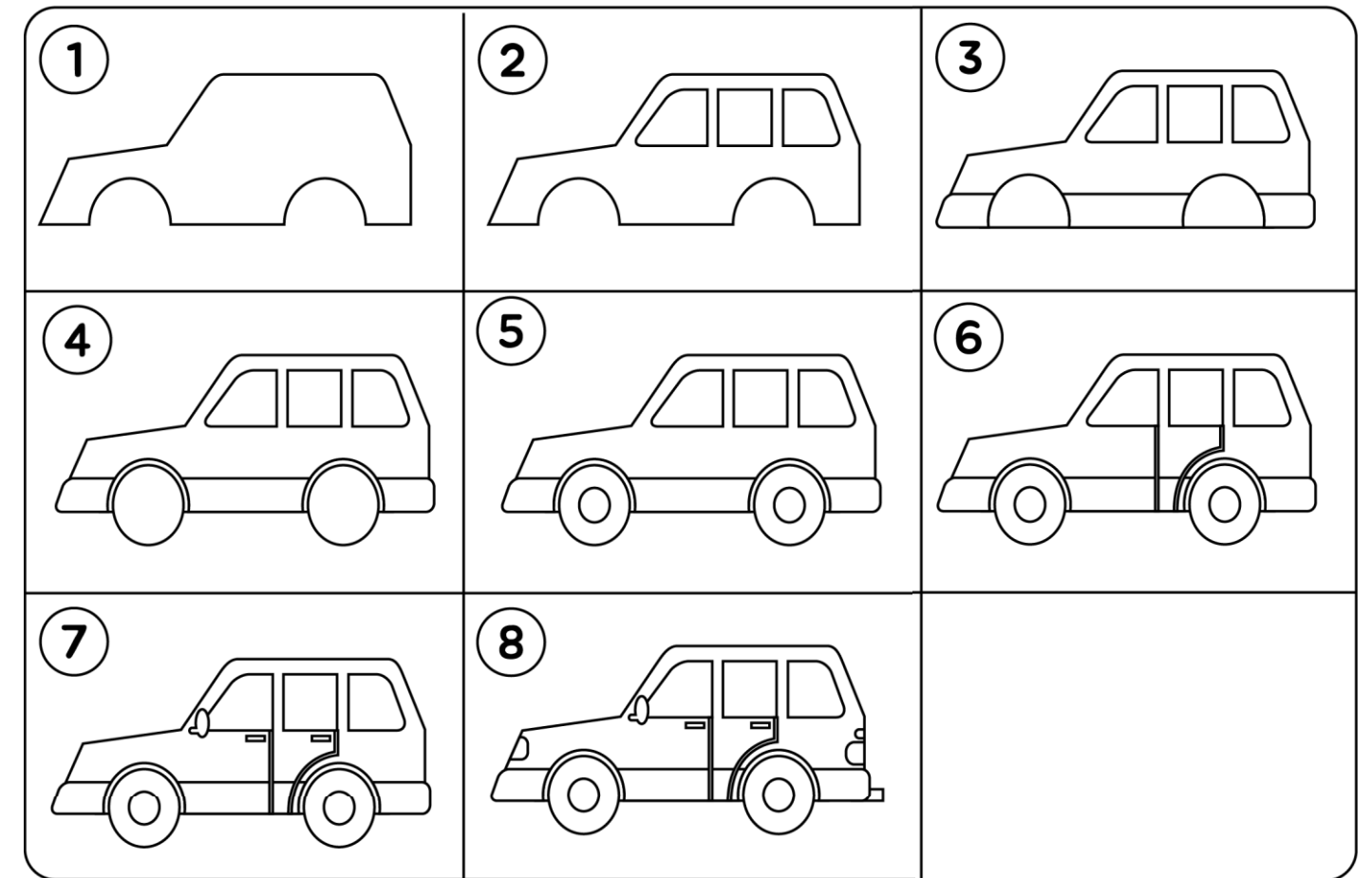

## Practice

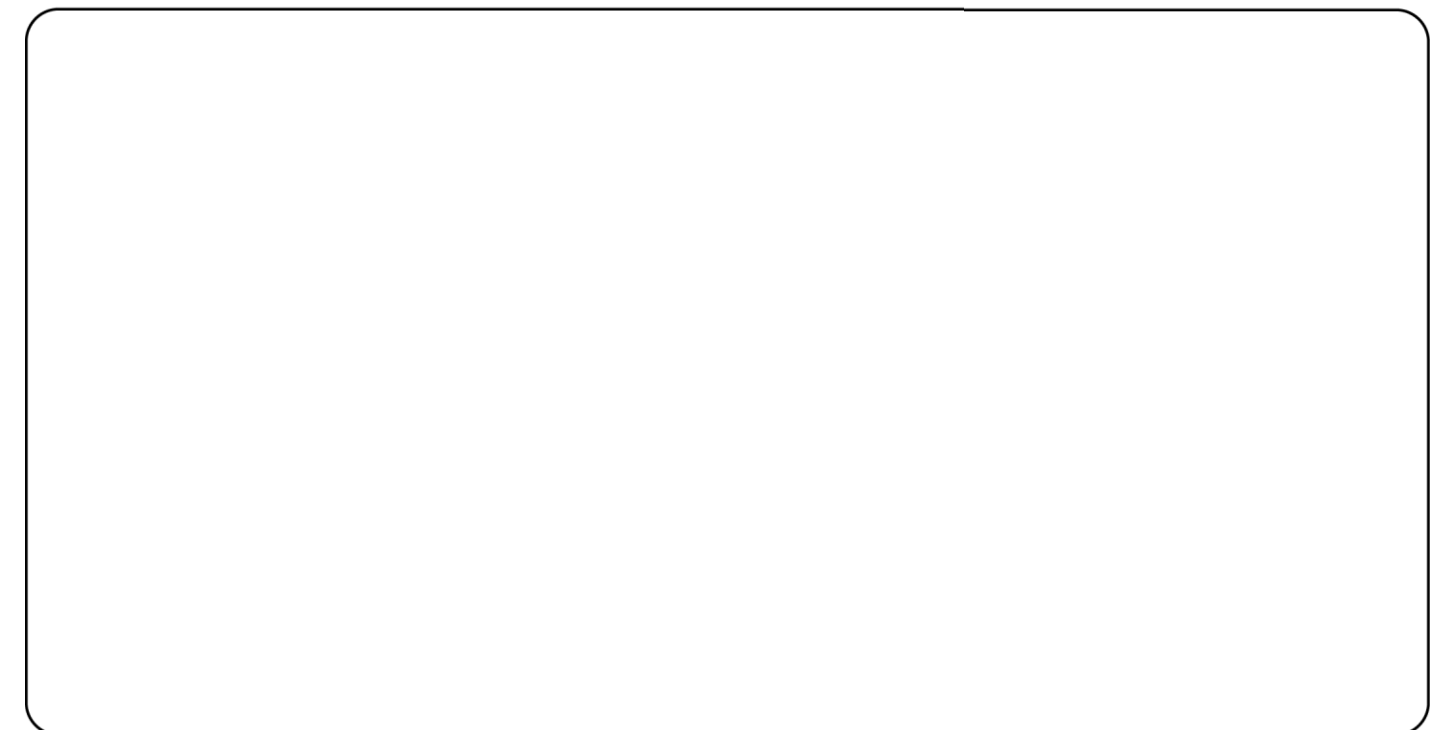

# Monkey

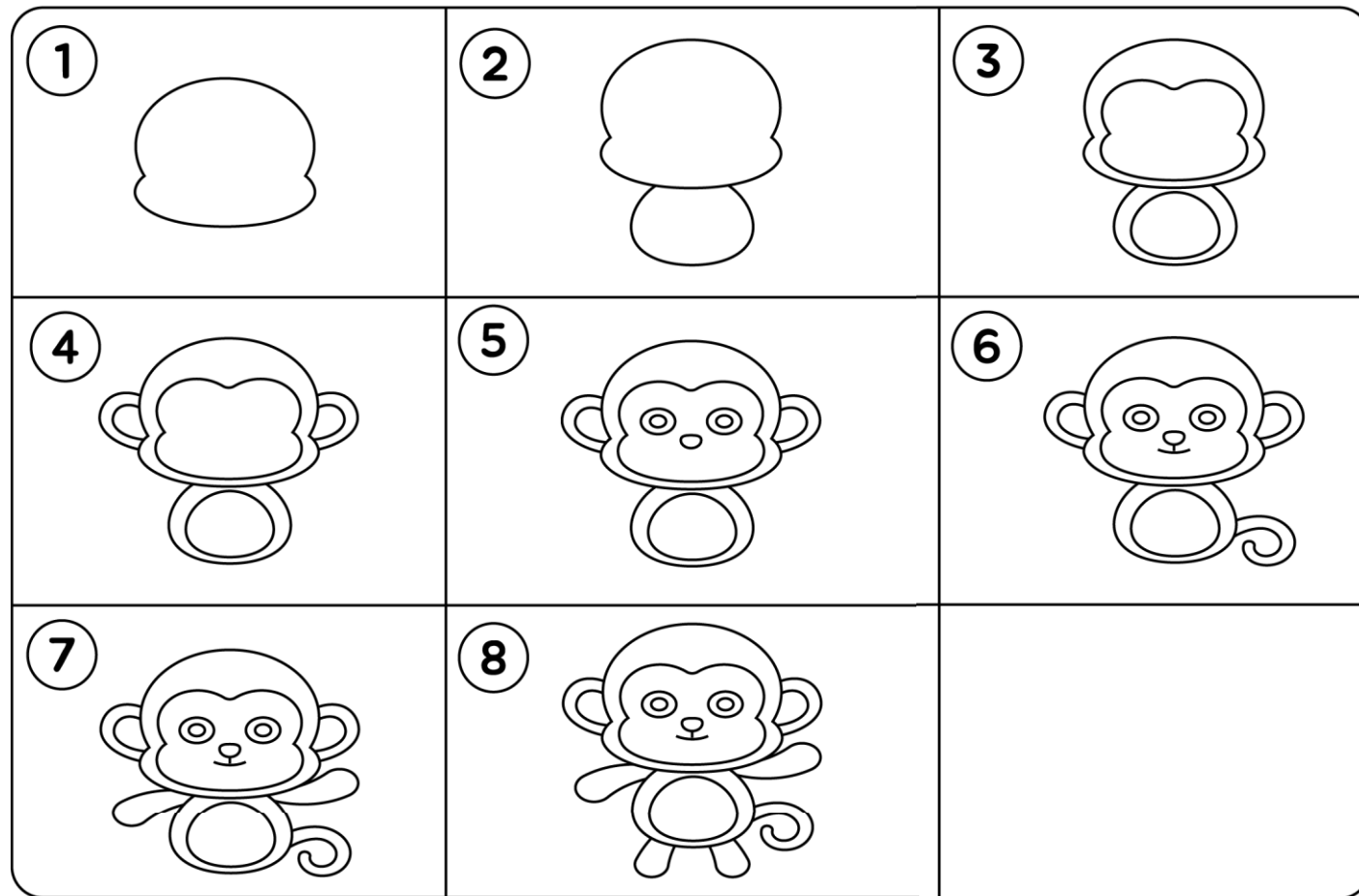

# Practice

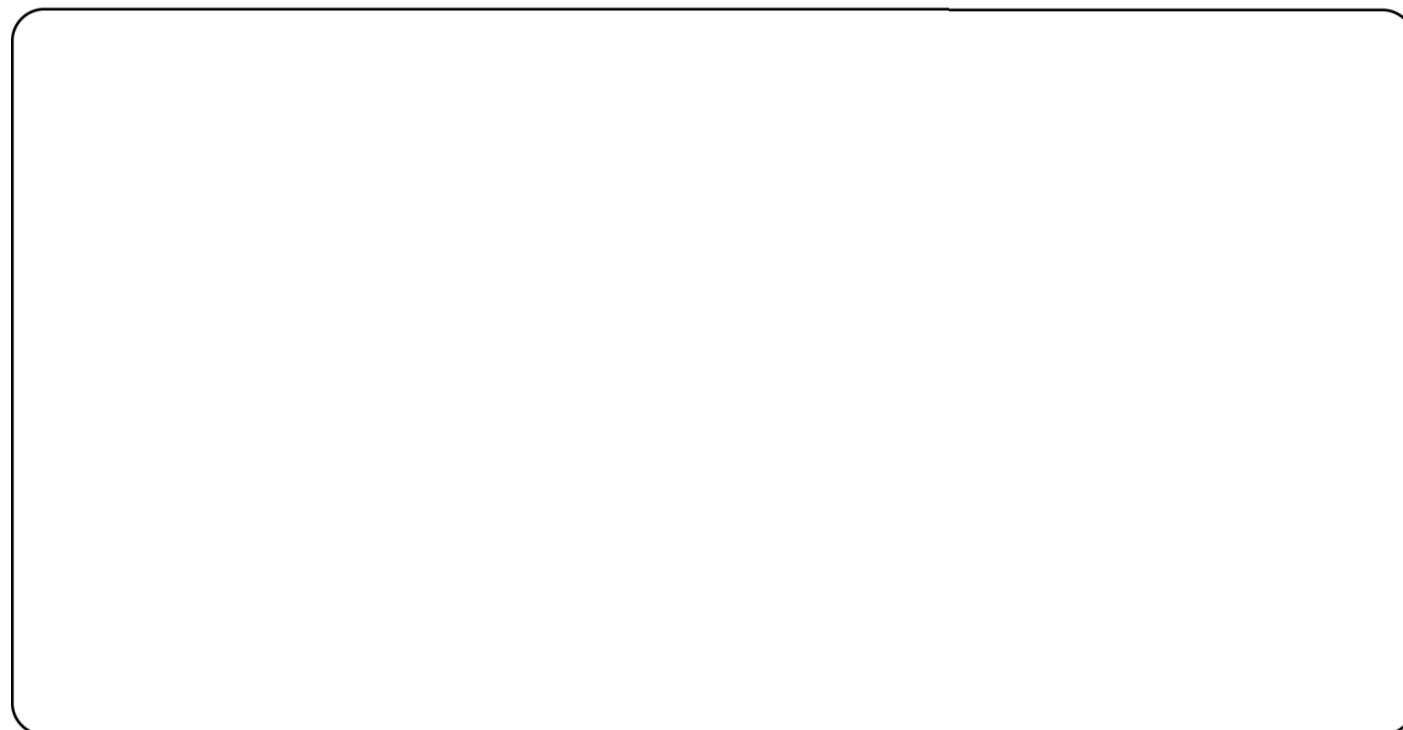

Proof